



First Team

**2009-2010
FULL-LINE
CATALOG**

800.649.3688

WWW.FIRSTTEAMINC.COM



MANUFACTURING SUPERIOR ATHLETIC EQUIPMENT

table of CONTENTS

what's NEW

Gymnasium Basketball Equipment

- Portable Basketball Systems Pgs 4-13
- Wall Mounted Basketball Systems Pgs 14-25
- Backboard Height Adjusters Pg 26
- Gymnasium Upgrade Packages Pg 27
- Competition Breakaway Basketball Goals Pgs 28, 29
- Competition Glass Backboards Pgs 30, 31
- Other Gymnasium Backboards Pgs 32, 33
- Six-Shooter, Ball Carts, Wall Padding Pgs 34-36

Outdoor Basketball Systems

- Adjustable Basketball Systems Pgs 38-48
- Pool Deck Basketball Systems Pgs 49-51
- Fixed Height Basketball Systems Pgs 52-58

Playground/Residential Goals

- Fixed Basketball Goals (Non-Flex) Pg 59
- Flex Basketball Goals Pg 60

Playground/Specialty Backboards

- Steel & Aluminum Backboards Pg 61
- Fiberglass Backboards Pg 62
- Acrylic Backboards Pg 63
- Tempered Glass Backboards Pgs 64, 65

Basketball Accessories

- Backboard Padding Pg 66
- Safety Padding Pg 67
- Miscellaneous Basketball Accessories Pgs 68, 69
- Competition Basketball Nets & Chain Nets Pg 70
- Basketball Court Diagram Pg 70
- Pop-A-Shot Home Electronic Basketball Game Pg 71

Player Benches and Bleachers

- Teammate Player Benches Pg 72
- FanStand Indoor Tip-N-Roll Bleachers Pg 73
- FanStand Indoor/Outdoor Bleachers Pg 74
- CrowdPleaser Indoor/Outdoor Bleachers Pg 75

Soccer Equipment

- World Class Port./Perm./Semi-Perm. Soccer Goals ... Pgs 76, 77
- Golden Goal Port./Perm./Semi-Perm. Soccer Goals .. Pgs 78, 79
- Freekick Backyard Portable Soccer Goal Pg 80
- Soccer Accessories Pgs 81, 82
- Soccer Field Diagram Pg 82

Volleyball Equipment

- Competition Volleyball Sets Pgs 83-85
- Recreational Volleyball Sets Pgs 86, 87
- RollaBlast Portable Competition Volleyball Set Pg 88
- Volleyball Accessories Pgs 89, 90
- Volleyball Court Diagram Pg 90



New Colors For Backboard Pads

BR Brick Red	SO Sienna Orange	DG Desert Gold	SB Saddle Brown
------------------------	----------------------------	--------------------------	---------------------------

Multi-Colored Pole Pads



AT FIRST TEAM



Indoor and Outdoor Bleachers

Portable & Fixed Player Benches



Digital Printed Wall Pads



Astro™ Volleyball Set



Pop-A-Shot Arcade Basketball Games



RollaBlast™ Volleyball Set



World Class™ Soccer Goals



Lacross Goal

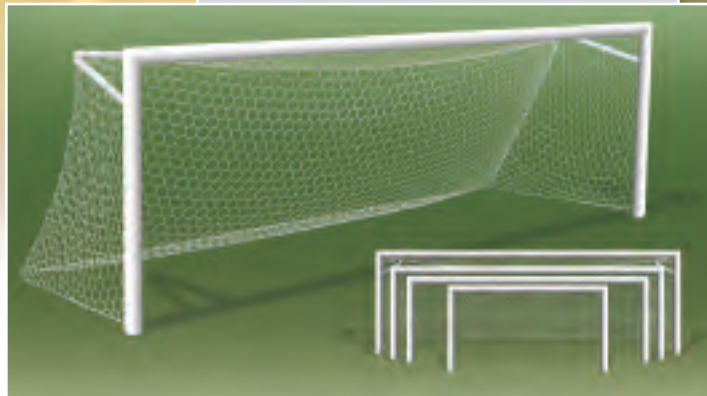

- Official Competition Lacrosse Goal
- Meets all NCAA & NFHS Rules
- Sold Individually & Includes Net
- Superior Net Attachment Design
- Lifetime Superior Warranty
- Approx. Shipping Weight: 75 lbs. ea.

the HURRICANE

PORTABLE BASKETBALL SYSTEM



• **HEIGHT ADJUSTABLE** - Adjust the rim to lower heights and the HURRICANE is great for little leagues and youth camps.

• **PORTABILITY** - The HURRICANE rolls easily on 8" non-marking casters and folds into a compact storage position.

Response™
tempered glass



• All First Team goals are direct mounted to eliminate backboard breakage when players hang on the rim

• Bolt-on TuffGuard™ backboard padding

The Hurricane competition style portable basketball goal is designed for fieldhouse, gymnasium and upper-end recreational or church use.

The Hurricane's massive extension arm features an upper and lower boom support. The extension distance from base to backboard is 96" meeting all NCAA and National High School

Federation requirements. The unit comes equipped with First Team's top of the line FT235 Unbreakable 42"x72" competition tempered glass backboard, FT196 Full-Tilt™ 180° breakaway goal and FT72C TuffGuard™ bolt-on backboard padding. These are the same components used in high schools and colleges throughout the country.

The Hurricane is also height adjustable. Rim height adjustments from 10' down to 6' are made easily with its "Spring-Aided" design. To adjust, simply pull the pin located on the adjustment rod, raise or lower the unit as needed and replace the pin. One person can easily roll the unit into place and set up quickly and easily.

Heavy foam padding, available in an array of colors, protects players on the front, sides and back of the base. The unit is extremely stable as well as durable and will not tip over when players hang on the rim. For additional support, rear hold downs are included as required by the NCAA and NHSF for competition portable goals. Choose the Hurricane Triumph-FL package for installations on floating floors or Hurricane Triumph-ST for all other flooring surfaces.

Floor load on the wheels is: 350 psi.
All Hurricane portable basketball goals are covered by First Team's unmatched Lifetime Superior Warranty!

WARNING!

Failure to install customer supplied ballast according to instructions could result in serious injury.

• Upper and Lower boom supports

• Base to backboard extension distance is 96"

• Rim height adjusts for smaller players

• Compact & Easy to roll

FREE!

LTR 85
Base Pad
Lettering
Upon Request

• Safety padding covers front, sides and back of base unit

• 5" non-marking foot pads lock unit into position for play

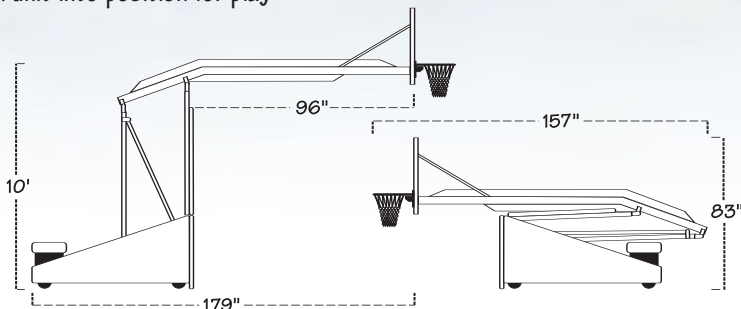

HURRICANE PACKAGE OPTIONS



HURRICANE TRIUMPH-FL



- Hurricane Portable Base Unit
- Hurricane Base Padding (Any Color)
- FT235 42"x72" Tempered Glass Backboard
- FT196 Full-Tilt Breakaway Goal
- FT72C Backboard Pad (any color)
- Includes optional tie-downs for floating floors
- Lifetime Superior Warranty
- Approx. Shipping Weight: 1590 lbs.



Order Hurricane Triumph-FL for floating floor anchors



HURRICANE TRIUMPH-ST

- Hurricane Portable Base Unit
- Hurricane Base Padding (Any Color)
- FT235 42"x72" Tempered Glass Backboard
- FT196 Full-Tilt Breakaway Goal
- FT72C Backboard Pad (any color)
- Includes optional tie-downs for standard floors
- Lifetime Superior Warranty
- Approx. Shipping Weight: 1590 lbs.

Order Hurricane Triumph-ST for standard floor anchors



KY Royal Blue	SC Scarlet	GL Gold	PR Purple	KG Kelly Green	BK Black	CB Columbia Blue	MR Maroon	GR Grey	NB Navy Blue	OR Orange	FG Forest Green	BR Brick Red	SO Sienna Orange	DG Desert Gold	SB Saddle Brown
-------------------------	----------------------	-------------------	---------------------	--------------------------	--------------------	----------------------------	---------------------	-------------------	------------------------	---------------------	---------------------------	------------------------	----------------------------	--------------------------	---------------------------

Hurricane base padding is available in these colors. Shades may vary slightly from color chart.

www.firstteaminc.com

First Team, Inc. • Hutchinson, Kansas • Toll-Free 1-800-649-3688

the

STORM

PORTABLE BASKETBALL SYSTEM



• Rim height adjusts for smaller players

• Extensive backboard selection in acrylic or tempered glass

• All First Team goals are direct mounted to eliminate backboard breakage when players hang on the rim

• Optional bolt-on TuffGuard™ backboard padding

• Post to backboard extension distance is 66"

FREE!
LTR 85

Base Pad Lettering Upon Request

• Adjustable overhang extension

• Safety padding covers front, sides and back of base unit

• Compact & Easy to roll

• 8" non-marking casters lock unit into position for play

The Storm is a portable basketball goal designed for use in a gymnasium, fieldhouse, multipurpose facility or recreational complex.

The Storm is adjustable. Height adjustments from 10' down to 6' are made easily with the Storm's spring-aided design. To adjust, simply pull the pin located on the adjustment rod, raise or lower the unit as needed and replace the pin.

The distance from the backboard to the base of the unit is 5'6" with the rim at the regulation 10' height and a minimum of 4' can be maintained at all lowered positions. Heavy foam padding, available in an array of colors, protects players on the front, sides and back of the base. The unit is extremely stable as well as durable, and will not tip over when players hang on the rim.

Floor load on the wheels is:
Rolling - 325 psi
Stationary - 325 psi

A variety of backboards ranging in size from 36"x60" to 42"x72" are available on the Storm. This allows the unit to be customized for a wide scope of applications and budgets.

Every Storm package comes with a Lifetime Superior Warranty.

• HEIGHT ADJUSTABLE - Pull the pin to adjust the rim to lower heights and the STORM works great for little leagues and youth camps.

• PORTABILITY - The STORM rolls easily on large 8" non-marking casters and folds down into a compact storage position requiring less space than similar portables.

WARNING!
Failure to install customer supplied ballast according to instructions could result in serious injury.

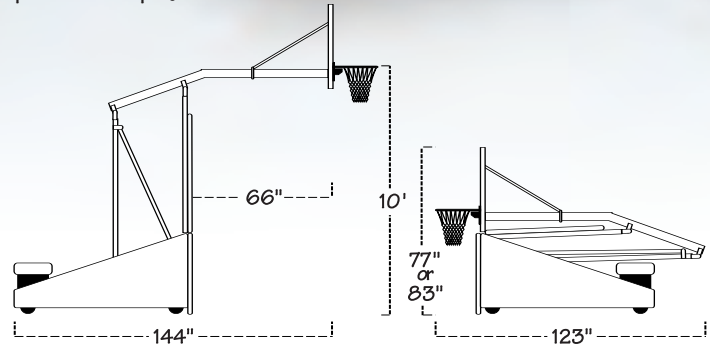

STORM PACKAGE OPTIONS

STORM SELECT

- Storm Portable Base Unit
- Base Padding (Any Color)
- FT220 36"x60" Acrylic Backboard
- FT186 Heavy Duty Flex Goal
- Lifetime Superior Warranty
- Approx. Shipping Weight: 1165 lbs.

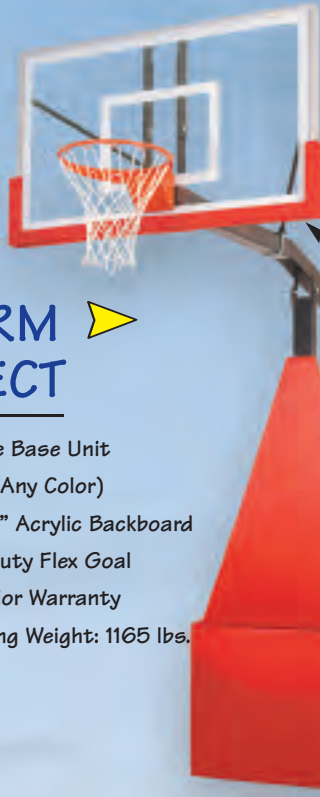

Packages shown with optional FT60 TuffGuard™ Backboard Padding

Response™
tempered glass

STORM PRO

- Storm Portable Base Unit
- Base Padding (Any Color)
- FT230 36"x60" Tempered Glass Backboard
- FT186 Heavy Duty Flex Goal
- Lifetime Superior Warranty
- Approx. Shipping Weight: 1210 lbs.

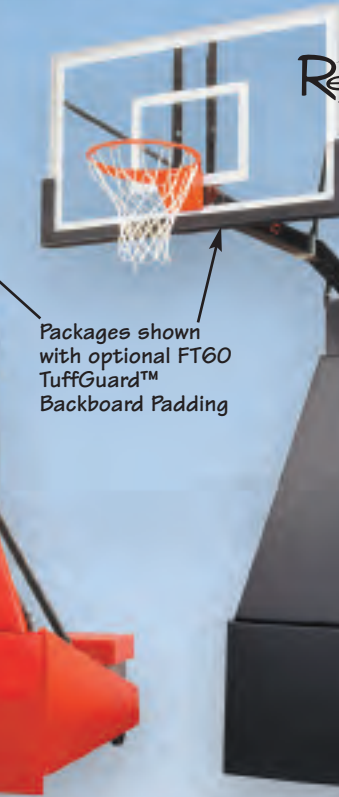

STORM SUPREME

- Storm Portable Base Unit
- Base Padding (Any Color)
- FT222 42"x72" Acrylic Backboard
- FT186 Heavy Duty Flex Goal
- Lifetime Superior Warranty
- Approx. Shipping Weight: 1210 lbs.



Packages shown with optional FT72C TuffGuard™ Backboard Padding

Response™
tempered glass

STORM ARENA

- Storm Portable Base Unit
- Base Padding (Any Color)
- FT232 42"x72" Tempered Glass Backboard
- FT186 Heavy Duty Flex Goal
- Lifetime Superior Warranty
- Approx. Shipping Weight: 1290 lbs.

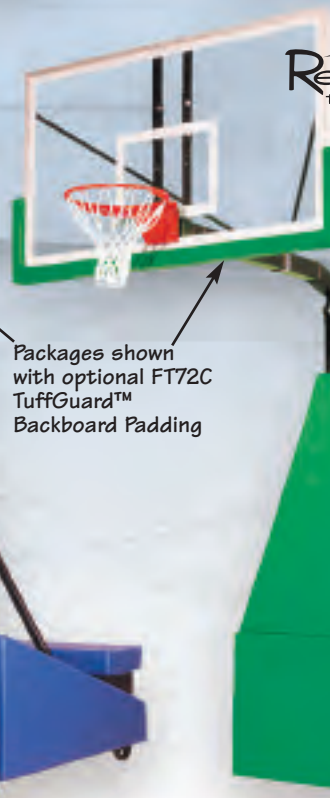

RY Royal Blue	SC Scarlet	GL Gold	PR Purple	KG Kelly Green	BK Black	CB Columbia Blue	MR Maroon	GR Grey	NB Navy Blue	OR Orange	FG Forest Green	BR Brick Red	SO Sienna Orange	DG Desert Gold	SB Saddle Brown
-------------------------	----------------------	-------------------	---------------------	--------------------------	--------------------	----------------------------	---------------------	-------------------	------------------------	---------------------	---------------------------	------------------------	----------------------------	--------------------------	---------------------------

Storm base padding is available in these colors. Shades may vary slightly from color chart.

www.firstteaminc.com

First Team, Inc. • Hutchinson, Kansas • Toll-Free 1-800-649-3688

the

THUNDER

PORTABLE BASKETBALL SYSTEM



- Extensive backboard selection in acrylic or tempered glass
- Additional H-Frame backboard support for extra ball response
- All First Team goals are direct mounted to eliminate backboard breakage when players hang on the rim
- Optional bolt-on TuffGuard™ backboard padding
- Rim Height Indicator
- Safety padding covers front of base unit
- Simple hand crank adjustment easily adjusts rim height from 10' - 6'6"

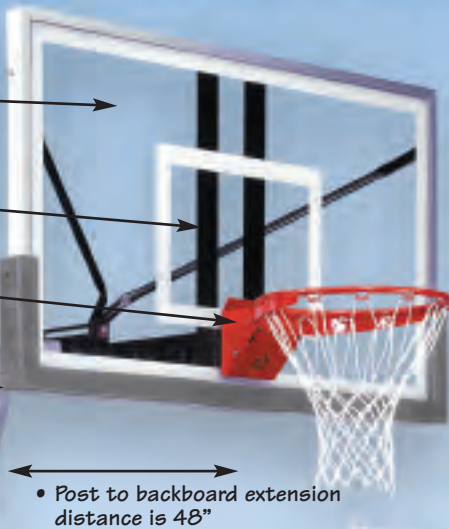

• Post to backboard extension distance is 48"

WARNING!

Failure to install customer supplied ballast according to instructions could result in serious injury.

FREE!

LTR 84
Base Pad Lettering
Upon Request

- Wheel brake locks unit in playing position

• Rim height adjusts for smaller players

• Compact & Easy to roll

- PORTABILITY - The THUNDER rolls easily on 6 non-marking roller wheels and folds down into a compact storage position requiring less space than similar portables.

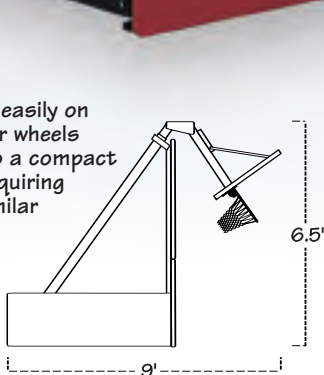

- HEIGHT ADJUSTABLE - Crank to adjust the rim to lower heights and the THUNDER works great for little leagues and youth camps.

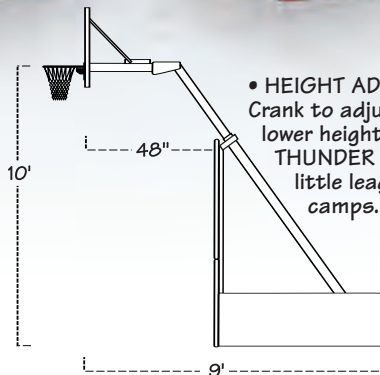

The Thunder portable basketball goal is an excellent choice for any school gymnasium, recreation complex, multipurpose facility or church in need of a high quality portable while working within a budget.

The Thunder is adjustable. Its simple to use hand crank allows for infinite height adjustments from regulation 10' down to 6'6". An easy to crank adjustment handle on the backside of the unit telescopes the backboard and rim to the desired playing height.

One person can easily move the Thunder portable goal. An easy to grip release crank unlocks the brake and six roller wheels contact the playing surface for smooth portability. The extension arm can quickly drop down to allow the unit to pass under any standard height double doors.

The distance from the backboard to the base of the unit is 4' with the rim at the regulation 10' height. This allows the base of the unit to sit "off the court" for player safety. Heavy foam padding covers the entire front of the unit for additional safety. Padding is available in several colors.

The unit is durable and stable enough to withstand slam dunk action and will not tip over when players hang on the rim.

Floor load on the wheels is:

Rolling - 275 psi

Stationary - 210 psi

A variety of backboards ranging from 36"x48" to 36"x60" are available on the Thunder. This allows the unit to meet an array of facilities and budget needs.

Every Thunder package comes with a Lifetime Superior Warranty.

THUNDER PACKAGE OPTIONS



THUNDER SELECT

- Thunder Portable Base Unit
- Base Padding (Any Color)
- FT220 36"x60" Acrylic Backboard
- FT186 Heavy Duty Flex Goal
- Lifetime Superior Warranty
- Approx. Shipping Weight: 810 lbs.



Response[™]
tempered glass



THUNDER ULTRA

- Thunder Portable Base Unit
- Base Padding (Any Color)
- FT225 36"x54" Tempered Glass Backboard
- FT186 Heavy Duty Flex Goal
- Lifetime Superior Warranty
- Approx. Shipping Weight: 850 lbs.

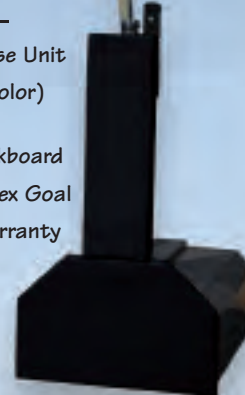

Response[™]
tempered glass



THUNDER PRO

- Thunder Portable Base Unit
- Base Padding (Any Color)
- FT230 36"x60" Tempered Glass Backboard
- FT186 Heavy Duty Flex Goal
- Lifetime Superior Warranty
- Approx. Shipping Weight: 855 lbs.



THUNDER SUPREME

- Thunder Portable Base Unit
- Base Padding (Any Color)
- FT222 42"x72" Acrylic Backboard
- FT186 Heavy Duty Flex Goal
- Lifetime Superior Warranty
- Approx. Shipping Weight: 855 lbs.



THUNDER ARENA

- Thunder Portable Base Unit
- Base Padding (Any Color)
- FT232 42"x72" Acrylic Backboard
- FT186 Heavy Duty Flex Goal
- Lifetime Superior Warranty
- Approx. Shipping Weight: 935 lbs.



RY Royal Blue	SC Scarlet	GL Gold	PR Purple	KG Kelly Green	BK Black	CB Columbia Blue	MR Maroon	GR Grey	NB Navy Blue	OR Orange	FG Forest Green	BR Brick Red	SO Sienna Orange	DG Desert Gold	SB Saddle Brown
-------------------------	----------------------	-------------------	---------------------	--------------------------	--------------------	----------------------------	---------------------	-------------------	------------------------	---------------------	---------------------------	------------------------	----------------------------	--------------------------	---------------------------

Thunder base padding is available in these colors. Shades may vary slightly from color chart.

www.firstteaminc.com

First Team, Inc. • Hutchinson, Kansas • Toll-Free 1-800-649-3688

the

FURY

PORTABLE BASKETBALL SYSTEM



• Selection of various clear acrylic and tempered glass backboards in sizes ranging from 36"x48" to 36"x60"

• All First Team goals are direct mounted to eliminate backboard breakage when players hang on the rim

• Optional bolt-on TuffGuard™ backboard padding

• Rim Height Indicator

• Post to backboard extension distance is 48" with rim at 10'
(Extension distance decreases as rim height is lowered)
9' - 44"
8' - 40"
7' - 35"

FREE!

LTR 83 Base Pad Lettering Upon Request

• Simple hand crank adjustment easily adjusts rim height from 10' - 6'6"

• Tough powder coat paint

• Safety padding covers front of base unit

• Front pad flips forward to roll

• Rim height adjusts for smaller players

• Neck drops down to pass through doorway

• Compact & Easy to roll

• Open to roll... Close to play

The Fury portable basketball goal is designed to withstand the demands of adult recreation centers while providing the flexibility necessary for many churches and elementary grade levels.

The Fury is infinitely adjustable. Simply turn the adjustment crank handle behind the unit to lower the rim height anywhere from 10' down to 6'6". The Fury's exclusive crank adjustment design is vastly superior in overall rigidity compared to similar goals using inferior "spring-slide" methods.

The Fury is engineered to be extremely easy to move. One person can transport the goal by flipping the lower pad forward and rolling into position. Return pad to upright position to lock base in place for play. The extension arm can be dropped without tools to allow the Fury to pass under doorways.

The backboard to base extension is 48" with the rim at regular height. This allows the Fury to sit "off-court" for player safety. Heavy padding, available in several colors, protects the player from contact with the base unit.

Floor load on the wheels is:

Rolling - 180 psi

Stationary - 140 psi

A variety of acrylic backboards are available on the Fury. Each package includes a high quality flex goal with net. Let the Fury help you make the most out of your facility and your budget.

Every Fury package comes with a Lifetime Limited Warranty.

• PORTABILITY - The FURY rolls easily on 6 non-marking roller wheels and folds down into a compact storage position.

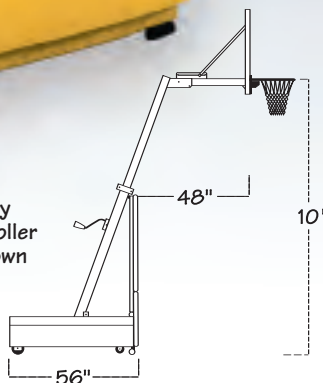

• HEIGHT ADJUSTABLE - Crank to adjust the rim to lower heights and the FURY works great for little leagues and youth camps.

WARNING!

Failure to install customer supplied ballast according to instructions could result in serious injury.

FURY PACKAGE OPTIONS



FURY II ▶

- Fury Portable Base Unit
- Fury Base Padding (Any Color)
- FT210 36"x48" Acrylic Backboard
- FT184 Recreational Flex Goal
- Lifetime Limited Warranty
- Approx. Shipping Weight: 485 lbs.



FURY III ▶

- Fury Portable Base Unit
- Fury Base Padding (Any Color)
- FT215 36"x54" Acrylic Backboard
- FT186 Heavy Duty Flex Goal
- Lifetime Limited Warranty
- Approx. Shipping Weight: 495 lbs.



FURY SELECT ▶

- Fury Portable Base Unit
- Fury Base Padding (Any Color)
- FT220 36"x60" Acrylic Backboard
- FT186 Heavy Duty Flex Goal
- Lifetime Limited Warranty
- Approx. Shipping Weight: 505 lbs.



FURY TURBO ▶

- Fury Portable Base Unit
- Fury Base Padding (Any Color)
- FT216 36"x54" Tempered Glass Backboard
- Supplemental Backboard Support
- FT186 Heavy Duty Flex Goal
- Lifetime Limited Warranty
- Approx. Shipping Weight: 495 lbs.



FURY NITRO ▶

- Fury Portable Base Unit
- Fury Base Padding (Any Color)
- FT221 36"x60" Tempered Glass Backboard
- Supplemental Backboard Support
- FT186 Heavy Duty Flex Goal
- Lifetime Limited Warranty
- Approx. Shipping Weight: 505 lbs.



RY Royal Blue	SC Scarlet	GL Gold	PR Purple	KG Kelly Green	BK Black	CB Columbia Blue	MR Maroon	GR Grey	NB Navy Blue	OR Orange	FG Forest Green	BR Brick Red	SO Sienna Orange	DG Desert Gold	SB Saddle Brown
-------------------------	----------------------	-------------------	---------------------	--------------------------	--------------------	----------------------------	---------------------	-------------------	------------------------	---------------------	---------------------------	------------------------	----------------------------	--------------------------	---------------------------

Fury base padding is available in these colors. Shades may vary slightly from color chart.

www.firstteaminc.com

First Team, Inc. • Hutchinson, Kansas • Toll-Free 1-800-649-3688

the

RAMPAGE

PORTABLE BASKETBALL SYSTEM



• Selection of various clear acrylic and tempered glass backboards in sizes ranging from 36"x48" to 36"x60"

• All First Team goals are direct mounted to eliminate backboard breakage when players hang on the rim

• Optional bolt-on TuffGuard™ backboard padding

• Simple hand crank adjustment easily adjusts rim height from 10' - 6.5'

• Foot lever raises unit onto castor for rolling

• Tough powder coat paint

• Safety padding covers front of base unit

• Rim height adjusts for smaller players

• Compact & Easy to roll

• Optional FT82BC Ballast Box Cover Padding

• PORTABILITY - The RAMPAGE rolls easily on 3 non-marking roller wheels and folds down into a compact storage position.

• HEIGHT ADJUSTABLE - Crank to adjust the rim to lower heights and the RAMPAGE works great for residential or recreational use.

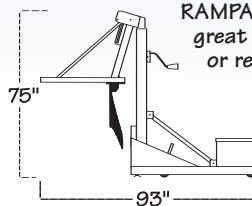
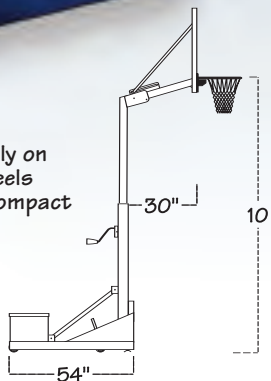

The Rampage portable basketball goal is by far the best performing unit in its class. No other portable goal offers this level of rigidity, portability and simple height adjustment at such an affordable price.

Infinite rim height adjustment can be made with the easy crank handle located on the back of the vertical mast. The rim height indicator labels determine rim heights from 10' to 6'6". The Rampage uses our exclusive crank-up design, which is far superior to similar goals using "spring-slide" methods.

The Rampage can easily be transported across a gym floor or up a driveway. Simply depress the foot lever located on the base unit for transport. Flip the lever back up for play. The extension arm drops down easily without tools to allow the Rampage to pass under doorways for storage rooms or garages. The backboard to base extension is 30" at all rim heights. The front base and stem are covered with thick vinyl padding for player safety. Padding is available in several choices of colors.

A selection of acrylic backboards is available on the Rampage. Each package includes a high quality flex goal with net. Get in the game with First Team's Rampage.

Every Rampage package comes with a Lifetime Limited Warranty.

WARNING!

Failure to install customer supplied ballast according to instructions could result in serious injury.

RAMPAGE PACKAGE OPTIONS



RAMPAGE II

- Rampage Portable Base Unit
- Rampage Base Padding (Choice of Color)
- FT210 36"x48" Acrylic Backboard
- FT184 Recreational Flex Goal
- Lifetime Limited Warranty
- Approx. Shipping Weight: 385 lbs.



RAMPAGE III

- Rampage Portable Base Unit
- Rampage Base Padding (Choice of Color)
- FT215 36"x54" Acrylic Backboard
- FT186 Heavy Duty Flex Goal
- Lifetime Limited Warranty
- Approx. Shipping Weight: 395 lbs.



RAMPAGE SELECT

- Rampage Portable Base Unit
- Rampage Base Padding (Choice of Color)
- FT220 36"x60" Acrylic Backboard
- FT186 Heavy Duty Flex Goal
- Lifetime Limited Warranty
- Approx. Shipping Weight: 405 lbs.



RAMPAGE TURBO

- Rampage Portable Base Unit
- Rampage Base Padding (Any Color)
- FT216 36"x54" Tempered Glass Backboard
- Supplemental Backboard Support
- FT186 Heavy Duty Flex Goal
- Lifetime Limited Warranty
- Approx. Shipping Weight: 395 lbs.



RAMPAGE NITRO

- Rampage Portable Base Unit
- Rampage Base Padding (Any Color)
- FT221 36"x60" Tempered Glass Backboard
- Supplemental Backboard Support
- FT186 Heavy Duty Flex Goal
- Lifetime Limited Warranty
- Approx. Shipping Weight: 405 lbs.



RY Royal Blue	SC Scarlet	GL Gold	PR Purple	KG Kelly Green	BK Black	CB Columbia Blue	MR Maroon	GR Grey	NB Navy Blue	OR Orange	FG Forest Green	BR Brick Red	SO Sienna Orange	DG Desert Gold	SB Saddle Brown
-------------------------	----------------------	-------------------	---------------------	--------------------------	--------------------	----------------------------	---------------------	-------------------	------------------------	---------------------	---------------------------	------------------------	----------------------------	--------------------------	---------------------------

Rampage base padding is available in these colors. Shades may vary slightly from color chart.

www.firstteaminc.com

First Team, Inc. • Hutchinson, Kansas • Toll-Free 1-800-649-3688

the

ROLLAJAM

PORTABLE BASKETBALL SYSTEM



- Selection of various clear acrylic and tempered glass backboards in sizes ranging from 36"x48" to 36"x60"

- All First Team goals are direct mounted to eliminate backboard breakage when players hang on the rim

- Optional bolt-on TuffGuard™ backboard padding

- Spring aided crank design makes adjustment effortless

- Rim Height Indicator shows height of rim

- Simple hand crank adjustment easily adjusts rim height from 10' - 6'6"

- Safety padding covers front of base unit

- Powder coat finish protects against the elements

- Post actuator retracts vertical post for rolling and storage

- Compact & Easy to roll

- Optional FTB1BC Ballast Box Cover Padding

There is nothing like the RollaJam! The RollaJam's unique design is the first premium grade, portable goal with the residential player in mind.

The RollaJam is crank adjustable from regulation height of 10' down to 7'. The crank handle is spring-aided to make adjustments easy for all ages. The rim height indicator accurately shows rim location.

To transport the RollaJam, simply retract the vertical post, using the post actuator located on the base unit. As the post pitches back, the unit lowers onto the transport wheel. Return the post to its vertical position for play. The goal rolls easily into any garage, or through any set of double doors. A high quality post pad covers the front of the unit.

Customize the RollaJam by selecting the backboard and rim combo that fits your game! Choose First Team's RollaJam for your court. With no hole to dig and no concrete to pour, you'll be "Jammin" in no time with the RollaJam!

Every RollaJam package comes with a Lifetime Limited Warranty.

WARNING!

Failure to install customer supplied ballast according to instructions could result in serious injury.

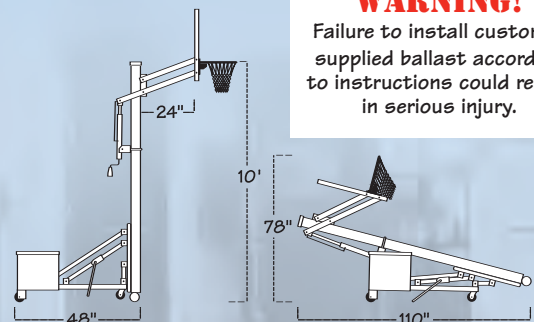

RollaJam base padding is available in these colors:



Shades may vary slightly from color chart.

ROLLAJAM PACKAGE OPTIONS



- Rollabout Portable Base Unit
- Rollabout Base Padding
- FT1300 Jam Arm System
- FT210 36"x48" Acrylic Backboard
- FT184 Recreational Flex Goal
- Lifetime Limited Warranty
- Approx. Shipping Weight: 385 lbs.

- Rollabout Portable Base Unit
- Rollabout Base Padding
- FT1300 Jam Arm System
- FT215 36"x54" Acrylic Backboard
- FT186 Heavy Duty Flex Goal
- Lifetime Limited Warranty
- Approx. Shipping Weight: 395 lbs.

- Rollabout Portable Base Unit
- Rollabout Base Padding
- FT1300 Jam Arm System
- FT220 36"x60" Acrylic Backboard
- FT186 Heavy Duty Flex Goal
- Lifetime Limited Warranty
- Approx. Shipping Weight: 405 lbs.

- Rollabout Portable Base Unit
- Rollabout Base Padding
- FT1300 Jam Arm System
- FT216 36" x 54" Temp. Glass Bkdb.
- FT186 Heavy Duty Flex Goal
- Lifetime Limited Warranty
- Approx. Shipping Weight: 405 lbs.

- Rollabout Portable Base Unit
- Rollabout Base Padding
- FT1300 Jam Arm System
- FT221 36" x 60" Temp. Glass Bkdb.
- FT186 Heavy Duty Flex Goal
- Lifetime Limited Warranty
- Approx. Shipping Weight: 405 lbs.

the

ROLLASPORT

PORTABLE BASKETBALL SYSTEM



- Selection of various clear acrylic backboards in sizes ranging from 36"x48" to 36"x60"

- Optional bolt-on TuffGuard™ backboard padding

- Fixed height extension arm secures to post using U-bolts

- Powder coat finish protects against the elements

- Safety padding covers front of base unit

- Post actuator retracts vertical post for rolling and storage

- All First Team goals are direct mounted to eliminate backboard breakage when players hang on the rim

- Compact & Easy to roll

- Optional FT81BC Ballast Box Cover Padding

The RollaSport is the clear choice in portable goals when frequent rim height adjustments are not necessary.

The extension arm on the RollaSport is attached to the vertical post using two heavy duty U-bolts. Though the RollaSport is considered a "fixed-height" portable goal, the U-bolts can be loosened, allowing the arm to be re-attached at any given height along the post.

To transport the RollaSport, simply retract the vertical post, using the post actuator located on the base unit. As the post pitches back, the RollaSport lowers onto the transport wheel. Return the post to its vertical position for play. The goal rolls easily into any garage, or through any set of double doors. A high quality post pad covers the front of the unit.

Backboards are available from 36" x 48" to 36" x 60", giving you a choice for your home court. No portable goal offers the same quality court time at such an excellent value as the RollaSport.

Every RollaSport package comes with a Lifetime Limited Warranty.

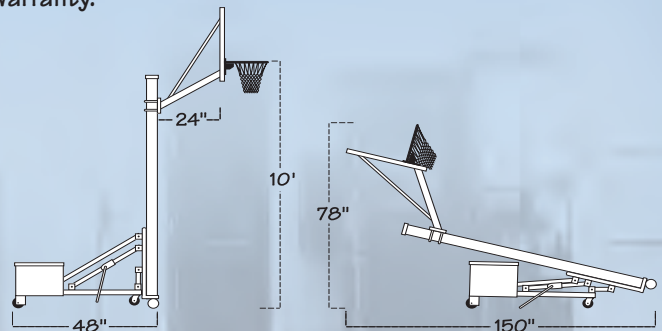

WARNING!

Failure to install customer supplied ballast according to instructions could result in serious injury.

ROLLASPORT PACKAGE OPTIONS

RollaSport base padding is available in these colors:



Shades may vary slightly from color chart.

See Accessories Section for Backboard Padding Options.



ROLLASPORT II

- Rollabout Portable Base Unit
- Rollabout Base Padding
- FT1150 Sport Arm System
- FT210 36"x48" Acrylic Backboard
- FT184 Recreational Flex Goal
- Lifetime Limited Warranty
- Approx. Shipping Weight: 335 lbs.



ROLLASPORT III

- Rollabout Portable Base Unit
- Rollabout Base Padding
- FT1150 Sport Arm System
- FT215 36"x54" Acrylic Backboard
- FT186 Heavy Duty Flex Goal
- Lifetime Limited Warranty
- Approx. Shipping Weight: 345 lbs.



ROLLASPORT SELECT

- Rollabout Portable Base Unit
- Rollabout Base Padding
- FT1150 Sport Arm System
- FT220 36"x60" Acrylic Backboard
- FT186 Heavy Duty Flex Goal
- Lifetime Limited Warranty
- Approx. Shipping Weight: 355 lbs.

www.firstteaminc.com

First Team, Inc. • Hutchinson, Kansas • Toll-Free 1-800-649-3688

the
POWERMOUNT
 STATIONARY WALLMOUNT STRUCTURE

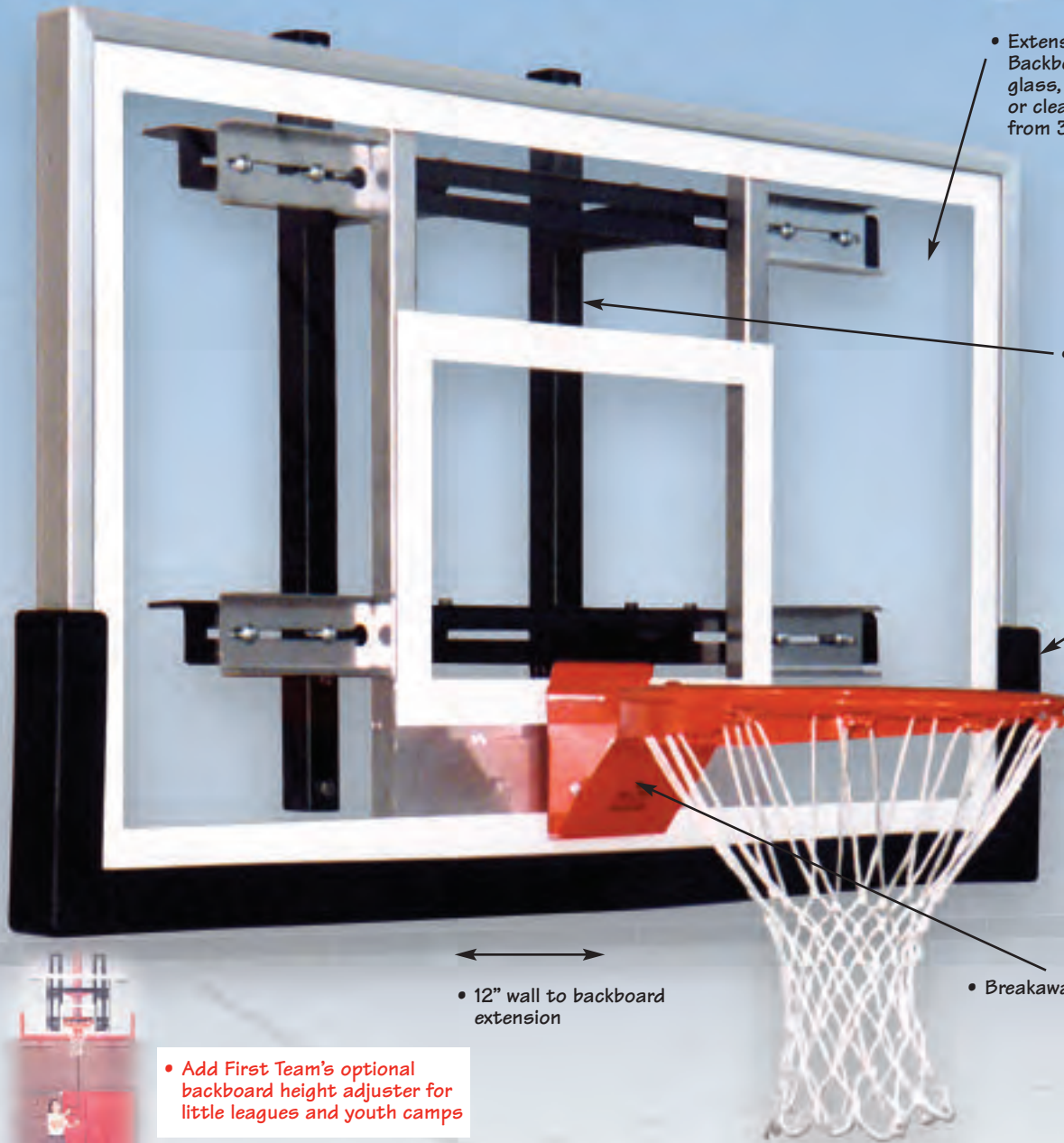

- Extensive backboard selection. Backboards are available in glass, steel, fiberglass or clear acrylic. Sizes vary from 36"x60" to 42"x72".

- Solid Square Tubing Construction With Black Powdercoat Finish

- Optional bolt-on TuffGuard™ backboard padding

↔
 • 12" wall to backboard extension

- Breakaway Rims

- Add First Team's optional backboard height adjuster for little leagues and youth camps

The PowerMount shooting station is designed to allow backboard installations in tight spaces where playing area is at a premium. If your facility requires a backboard installation close to a wall, call on First Team's PowerMount series!

The PowerMount structure provides quick and easy installation of a backboard on a wall with a minimal 12" of wall-to-backboard distance. First Team provides an array of prepackaged PowerMount options to choose from. The PowerMount can be

used with ANY backboard having a standard 20" x 35" mounting. However, selecting a PowerMount package is easy and guarantees component compatibility.

All PowerMount packages come with a Limited Lifetime Warranty.

POWERMOUNT PACKAGE OPTIONS

POWERMOUNT COMPETITOR



Shown with optional bolt-on
TuffGuard™ backboard padding

- FT1990 PowerMount System
- FT240 42"x72" Tempered Glass Backboard
- FT192 Competition Breakaway Goal
- Approx. Shipping Weight: 275 lbs.

POWERMOUNT CONTENDER



- FT1990 PowerMount System
- FT239 42"x72" Tempered Glass Backboard
- FT190 Competition Breakaway Goal
- Approx. Shipping Weight: 265 lbs.

POWERMOUNT SELECT



- FT1990 PowerMount System
- FT36 Silver Support Structure
- FT220 36"x60" Acrylic Backboard
- FT186 Heavy Duty Flex Goal
- Approx. Shipping Weight: 130 lbs.

POWERMOUNT PRO



- FT1990 PowerMount System
- FT36 Silver Support Structure
- FT230 36"x60" Tempered Glass Backboard
- FT186 Heavy Duty Flex Goal
- Approx. Shipping Weight: 180 lbs.

POWERMOUNT SUPREME



- FT1990 PowerMount System
- FT42 Silver Support Structure
- FT222 42"x72" Acrylic Backboard
- FT186 Heavy Duty Flex Goal
- Approx. Shipping Weight: 180 lbs.

POWERMOUNT ADVANTAGE



- FT1990 PowerMount System
- FT233 39"x54" Tempered Glass Backboard
- FT190 Competition Breakaway Goal
- Approx. Shipping Weight: 180 lbs.

POWERMOUNT AGGRESSOR



- FT1990 PowerMount System
- FT260B 42"x60" Steel Backboard
- FT186 Heavy Duty Flex Goal
- Approx. Shipping Weight: 200 lbs.

POWERMOUNT REBOUND



- FT1990 PowerMount System
- FT275 39"x54" Fiberglass Backboard
- FT186 Heavy Duty Flex Goal
- Approx. Shipping Weight: 180 lbs.

POWERMOUNT PERFORMANCE



- FT1990 PowerMount System
- FT280 42"x72" Fiberglass Backboard
- FT186 Heavy Duty Flex Goal
- Approx. Shipping Weight: 255 lbs.

the SUPERMOUNT 46

STATIONARY WALLMOUNT STRUCTURE

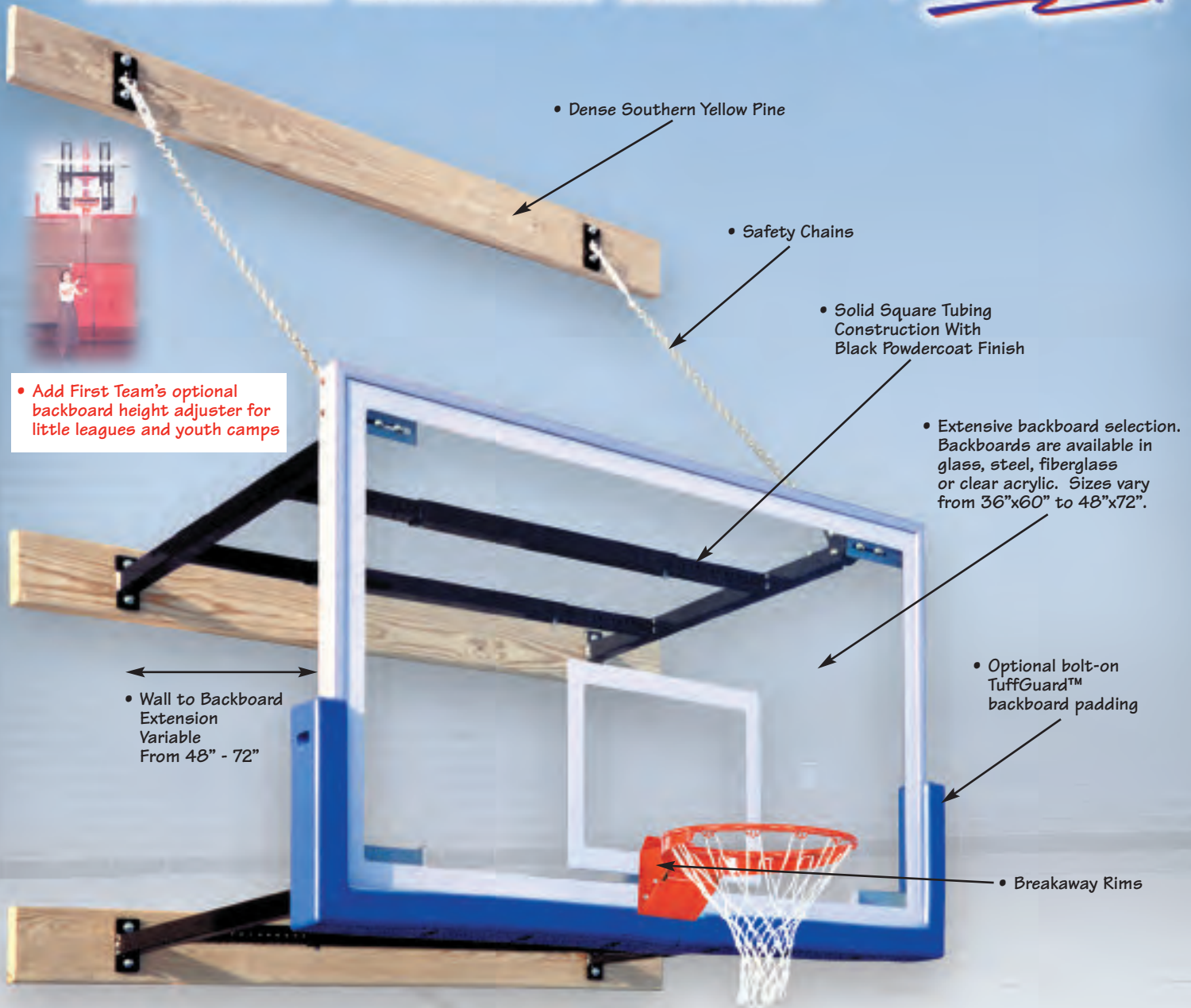

• Dense Southern Yellow Pine

• Safety Chains

• Solid Square Tubing Construction With Black Powdercoat Finish

• Extensive backboard selection. Backboards are available in glass, steel, fiberglass or clear acrylic. Sizes vary from 36"x60" to 48"x72".

• Optional bolt-on TuffGuard™ backboard padding

• Breakaway Rims

• Wall to Backboard Extension Variable From 48" - 72"

• Add First Team's optional backboard height adjuster for little leagues and youth camps

The SuperMount46 simplifies the task of installing a top quality wall-mounted basketball structure.

Never before has it been so simple to purchase and install a commercial quality wall-mounted basketball system. With First Team's SuperMount46 there is no need to calculate exact extension requirements before ordering. The SuperMount46 is specifically

designed to provide wall-to-backboard extension distances anywhere from 4' - 6' during installation. This allows the unit to be "fine-tuned" to match the court markings on the floor. You will avoid costly rework and field modifications commonly caused by measurement errors.

Additionally, the SuperMount46 is so versatile it can be configured to match up to any basketball

backboard. So no matter what backboard you prefer, you know the SuperMount46 is compatible.

Select from First Team's broad array of package configurations to satisfy the needs of your facility. Remember, for additional safety, First Team offers optional bolt-on padding for most SuperMount46 packages.

Every SuperMount46 System comes with a Lifetime Limited Warranty.

SUPERMOUNT 46 PACKAGE OPTIONS

**SUPERMOUNT 46
VICTORY**



**SUPERMOUNT 46
TRIUMPH**



**SUPERMOUNT 46
TRADITION**



**SUPERMOUNT 46
SELECT**



Shown with optional bolt-on
TuffGuard™ backboard padding

- FT2000 SuperMount 46 System
- FT234 42"x72" Glass Backboard
- FT190 Competition Breakaway Goal
- Approx. Shipping Weight: 493 lbs.

- FT2000 SuperMount 46 System
- FT235 42"x72" Glass Backboard
- FT192 Competition Breakaway Goal
- Approx. Shipping Weight: 503 lbs.

- FT2000 SuperMount 46 System
- FT236 48"x72" Glass Backboard
- FT192 Competition Breakaway Goal
- Approx. Shipping Weight: 513 lbs.

- FT2000 SuperMount 46 System
- FT36 Silver Support Structure
- FT220 36"x60" Acrylic Backboard
- FT186 Heavy Duty Flex Goal
- Approx. Shipping Weight: 390 lbs.

**SUPERMOUNT 46
PRO**



**SUPERMOUNT 46
SUPREME**



**SUPERMOUNT 46
ADVANTAGE**



**SUPERMOUNT 46
MAVERICK**



- FT2000 SuperMount 46 System
- FT36 Silver Support Structure
- FT230 36"x60" Glass Backboard
- FT186 Heavy Duty Flex Goal
- Approx. Shipping Weight: 435 lbs.

- FT2000 SuperMount 46 System
- FT42 Silver Support Structure
- FT222 42"x72" Acrylic Backboard
- FT186 Heavy Duty Flex Goal
- Approx. Shipping Weight: 435 lbs.

- FT2000 SuperMount 46 System
- FT233 39"x54" Glass Backboard
- FT190 Competition Breakaway Goal
- Approx. Shipping Weight: 423 lbs.

- FT2000 SuperMount 46 System
- FT231 40"x54" Glass Backboard
- FT186 Heavy Duty Flex Goal
- Approx. Shipping Weight: 453 lbs.

**SUPERMOUNT 46
AGGRESSOR**



**SUPERMOUNT 46
MAGNUM**



**SUPERMOUNT 46
REBOUND**



**SUPERMOUNT 46
PERFORMANCE**



- FT2000 SuperMount 46 System
- FT260B 42"x60" Steel Backboard
- FT186 Heavy Duty Flex Goal
- Approx. Shipping Weight: 453 lbs.

- FT2000 SuperMount 46 System
- FT265B 42"x72" Steel Backboard
- FT186 Heavy Duty Flex Goal
- Approx. Shipping Weight: 493 lbs.

- FT2000 SuperMount 46 System
- FT275 39"x54" Fiberglass Backboard
- FT186 Heavy Duty Flex Goal
- Approx. Shipping Weight: 410 lbs.

- FT2000 SuperMount 46 System
- FT280 42"x72" Fiberglass Backboard
- FT186 Heavy Duty Flex Goal
- Approx. Shipping Weight: 446 lbs.

www.firstteaminc.com

First Team, Inc. • Hutchinson, Kansas • Toll-Free 1-800-649-3688

the SUPERMOUNT 68

STATIONARY WALLMOUNT STRUCTURE

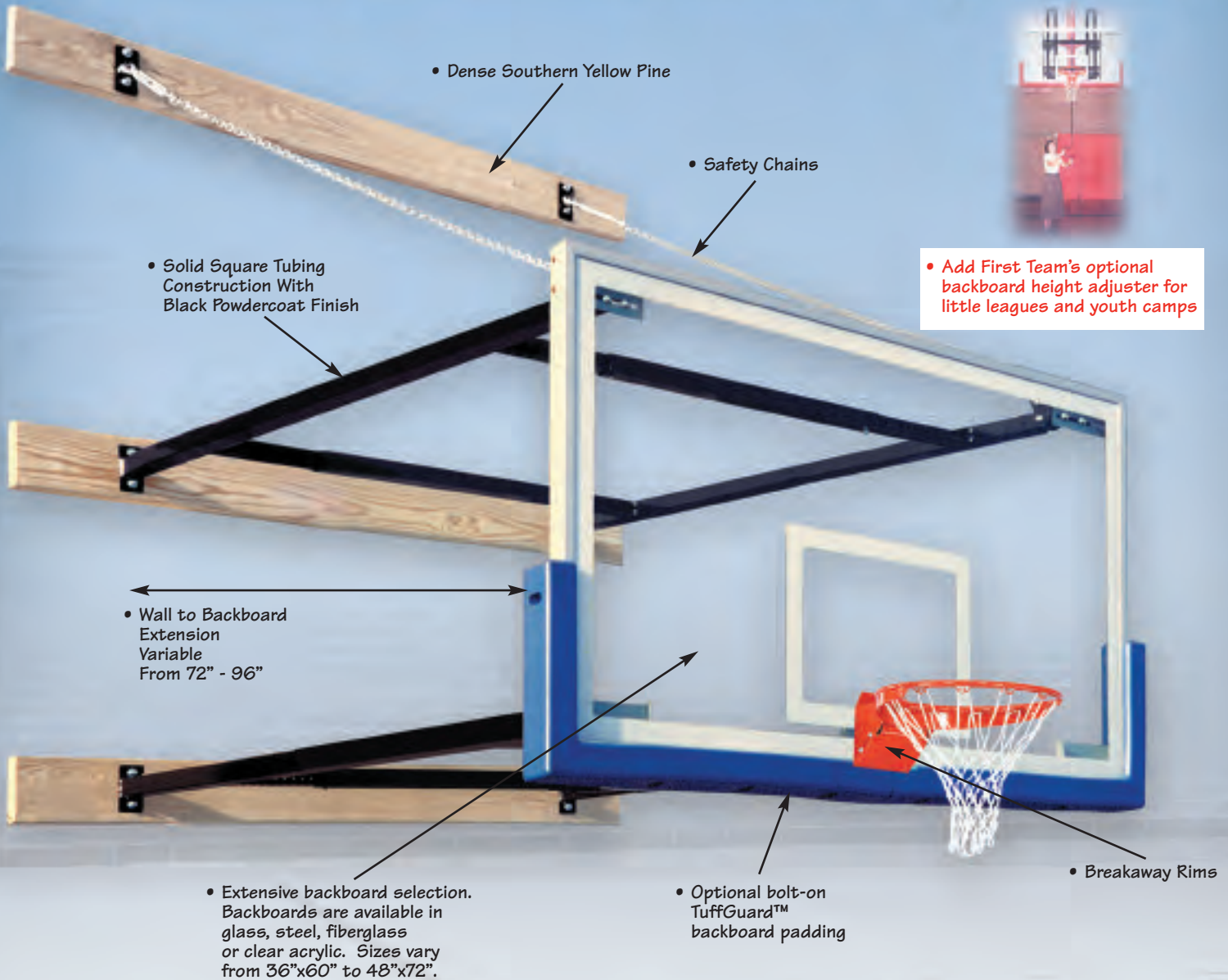

• Add First Team's optional backboard height adjuster for little leagues and youth camps

The SuperMount68 simplifies the task of installing a top quality wall-mounted basketball structure.

Never before has it been so simple to purchase and install a commercial quality wall-mounted basketball system. With First Team's SuperMount68 there is no need to calculate exact extension requirements before ordering.

The SuperMount68 is specifically

designed to provide wall-to-backboard extension distances anywhere from 6' - 8' during installation. This allows the unit to be "fine-tuned" to match the court markings on the floor. You will avoid costly rework and field modifications commonly caused by measurement errors.

Additionally, the SuperMount68 is so versatile it can be configured to match up to any basketball backboard. So no

matter what backboard you prefer, you know the SuperMount68 is compatible.

Select from First Team's broad array of package configurations to satisfy the needs of your facility. Remember, for additional safety, First Team offers optional bolt-on padding for most SuperMount68 packages.

Every SuperMount68 System comes with a Lifetime Limited Warranty.

SUPERMOUNT 68 PACKAGE OPTIONS

**SUPERMOUNT 68
VICTORY**



**SUPERMOUNT 68
TRIUMPH**



**SUPERMOUNT 68
TRADITION**



**SUPERMOUNT 68
SELECT**



Shown with optional bolt-on
TuffGuard™ backboard padding

- FT2010 SuperMount 68 System
- FT234 42"x72" Glass Backboard
- FT190 Competition Breakaway Goal
- Approx. Shipping Weight: 513 lbs.

- FT2010 SuperMount 68 System
- FT235 42"x72" Glass Backboard
- FT192 Competition Breakaway Goal
- Approx. Shipping Weight: 523 lbs.

- FT2010 SuperMount 68 System
- FT236 48"x72" Glass Backboard
- FT192 Competition Breakaway Goal
- Approx. Shipping Weight: 533 lbs.

- FT2010 SuperMount 68 System
- FT36 Silver Support Structure
- FT220 36"x60" Acrylic Backboard
- FT186 Heavy Duty Flex Goal
- Approx. Shipping Weight: 410 lbs.

**SUPERMOUNT 68
PRO**



**SUPERMOUNT 68
SUPREME**



**SUPERMOUNT 68
ADVANTAGE**



**SUPERMOUNT 68
MAVERICK**



- FT2010 SuperMount 68 System
- FT36 Silver Support Structure
- FT230 36"x60" Glass Backboard
- FT186 Heavy Duty Flex Goal
- Approx. Shipping Weight: 455 lbs.

- FT2010 SuperMount 68 System
- FT42 Silver Support Structure
- FT222 42"x72" Acrylic Backboard
- FT186 Heavy Duty Flex Goal
- Approx. Shipping Weight: 455 lbs.

- FT2010 SuperMount 68 System
- FT233 39"x54" Glass Backboard
- FT190 Competition Breakaway Goal
- Approx. Shipping Weight: 443 lbs.

- FT2010 SuperMount 68 System
- FT231 40"x54" Glass Backboard
- FT186 Heavy Duty Flex Goal
- Approx. Shipping Weight: 473 lbs.

**SUPERMOUNT 68
AGGRESSOR**



**SUPERMOUNT 68
MAGNUM**



**SUPERMOUNT 68
REBOUND**



**SUPERMOUNT 68
PERFORMANCE**



- FT2010 SuperMount 68 System
- FT260B 42"x60" Steel Backboard
- FT186 Heavy Duty Flex Goal
- Approx. Shipping Weight: 473 lbs.

- FT2010 SuperMount 68 System
- FT265B 42"x72" Steel Backboard
- FT186 Heavy Duty Flex Goal
- Approx. Shipping Weight: 513 lbs.

- FT2010 SuperMount 68 System
- FT275 39"x54" Fiberglass Backboard
- FT186 Heavy Duty Flex Goal
- Approx. Shipping Weight: 430 lbs.

- FT2010 SuperMount 68 System
- FT280 42"x72" Fiberglass Backboard
- FT186 Heavy Duty Flex Goal
- Approx. Shipping Weight: 466 lbs.

www.firstteaminc.com

First Team, Inc. • Hutchinson, Kansas • Toll-Free 1-800-649-3688

the SUPERMOUNT 80

STATIONARY WALLMOUNT STRUCTURE

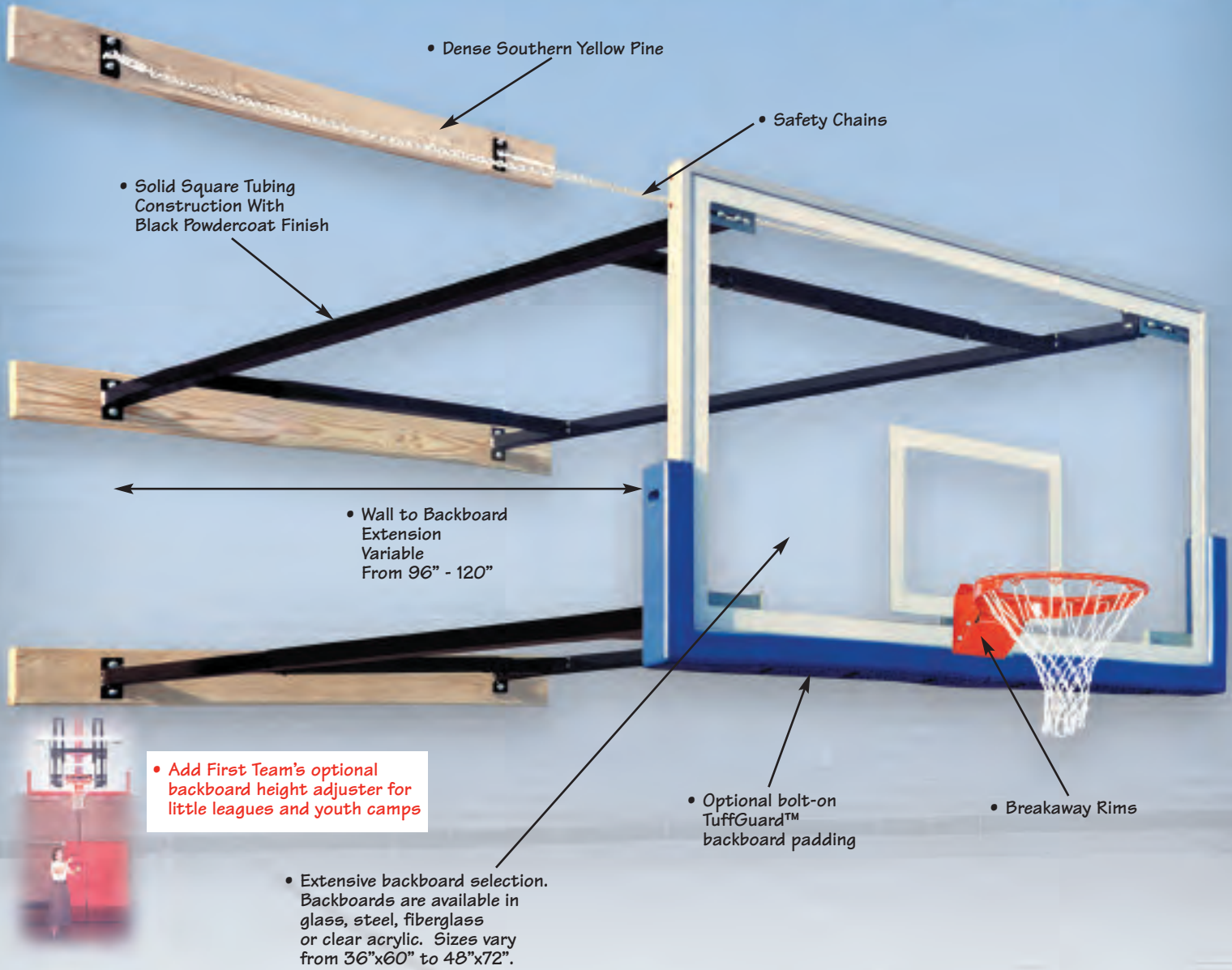

The SuperMount80 simplifies the task of installing a top quality wall-mounted basketball structure.

Never before has it been so simple to purchase and install a commercial quality wall-mounted basketball system. With First Team's SuperMount80 there is no need to calculate exact extension requirements before ordering. The SuperMount80 is specifically designed to provide wall-to-

backboard extension distances anywhere from 8' - 10' during installation. This allows the unit to be "fine-tuned" to match the court markings on the floor. You will avoid costly rework and field modifications commonly caused by measurement errors.

Additionally, the SuperMount80 is so versatile it can be configured to match up to any basketball backboard. So no matter what

backboard you prefer, you know the SuperMount80 is compatible.

Select from First Team's broad array of package configurations to satisfy the needs of your facility. Remember, for additional safety, First Team offers optional bolt-on padding for most SuperMount80 packages.

Every SuperMount80 System comes with a Lifetime Limited Warranty.

SUPERMOUNT 80 PACKAGE OPTIONS

SUPERMOUNT 80 VICTORY



Shown with optional bolt-on TuffGuard™ backboard padding

- FT2020 SuperMount 80 System
- FT234 42"x72" Glass Backboard
- FT190 Competition Breakaway Goal
- Approx. Shipping Weight: 533 lbs.

SUPERMOUNT 80 TRIUMPH



- FT2020 SuperMount 80 System
- FT235 42"x72" Glass Backboard
- FT192 Competition Breakaway Goal
- Approx. Shipping Weight: 543 lbs.

SUPERMOUNT 80 TRADITION



- FT2020 SuperMount 80 System
- FT236 48"x72" Glass Backboard
- FT192 Competition Breakaway Goal
- Approx. Shipping Weight: 553 lbs.

SUPERMOUNT 80 SELECT



- FT2020 SuperMount 80 System
- FT36 Silver Support Structure
- FT220 36"x60" Acrylic Backboard
- FT186 Heavy Duty Flex Goal
- Approx. Shipping Weight: 435 lbs.

SUPERMOUNT 80 PRO



- FT2020 SuperMount 80 System
- FT36 Silver Support Structure
- FT230 36"x60" Glass Backboard
- FT186 Heavy Duty Flex Goal
- Approx. Shipping Weight: 475 lbs.

SUPERMOUNT 80 SUPREME



- FT2020 SuperMount 80 System
- FT42 Silver Support Structure
- FT222 42"x72" Acrylic Backboard
- FT186 Heavy Duty Flex Goal
- Approx. Shipping Weight: 475 lbs.

SUPERMOUNT 80 ADVANTAGE



- FT2020 SuperMount 80 System
- FT233 39"x54" Glass Backboard
- FT190 Competition Breakaway Goal
- Approx. Shipping Weight: 463 lbs.

SUPERMOUNT 80 MAVERICK



- FT2020 SuperMount 80 System
- FT231 40"x54" Glass Backboard
- FT186 Heavy Duty Flex Goal
- Approx. Shipping Weight: 493 lbs.

SUPERMOUNT 80 AGGRESSOR



- FT2020 SuperMount 80 System
- FT260B 42"x60" Steel Backboard
- FT186 Heavy Duty Flex Goal
- Approx. Shipping Weight: 493 lbs.

SUPERMOUNT 80 MAGNUM



- FT2020 SuperMount 80 System
- FT265B 42"x72" Steel Backboard
- FT186 Heavy Duty Flex Goal
- Approx. Shipping Weight: 533 lbs.

SUPERMOUNT 80 REBOUND



- FT2020 SuperMount 80 System
- FT275 39"x54" Fiberglass Backboard
- FT186 Heavy Duty Flex Goal
- Approx. Shipping Weight: 450 lbs.

SUPERMOUNT 80 PERFORMANCE



- FT2020 SuperMount 80 System
- FT280 42"x72" Fiberglass Backboard
- FT186 Heavy Duty Flex Goal
- Approx. Shipping Weight: 486 lbs.

www.firstteaminc.com

First Team, Inc. • Hutchinson, Kansas • Toll-Free 1-800-649-3688

the FOLDAMOUNT 46

SIDE-FOLDING WALLMOUNT STRUCTURE

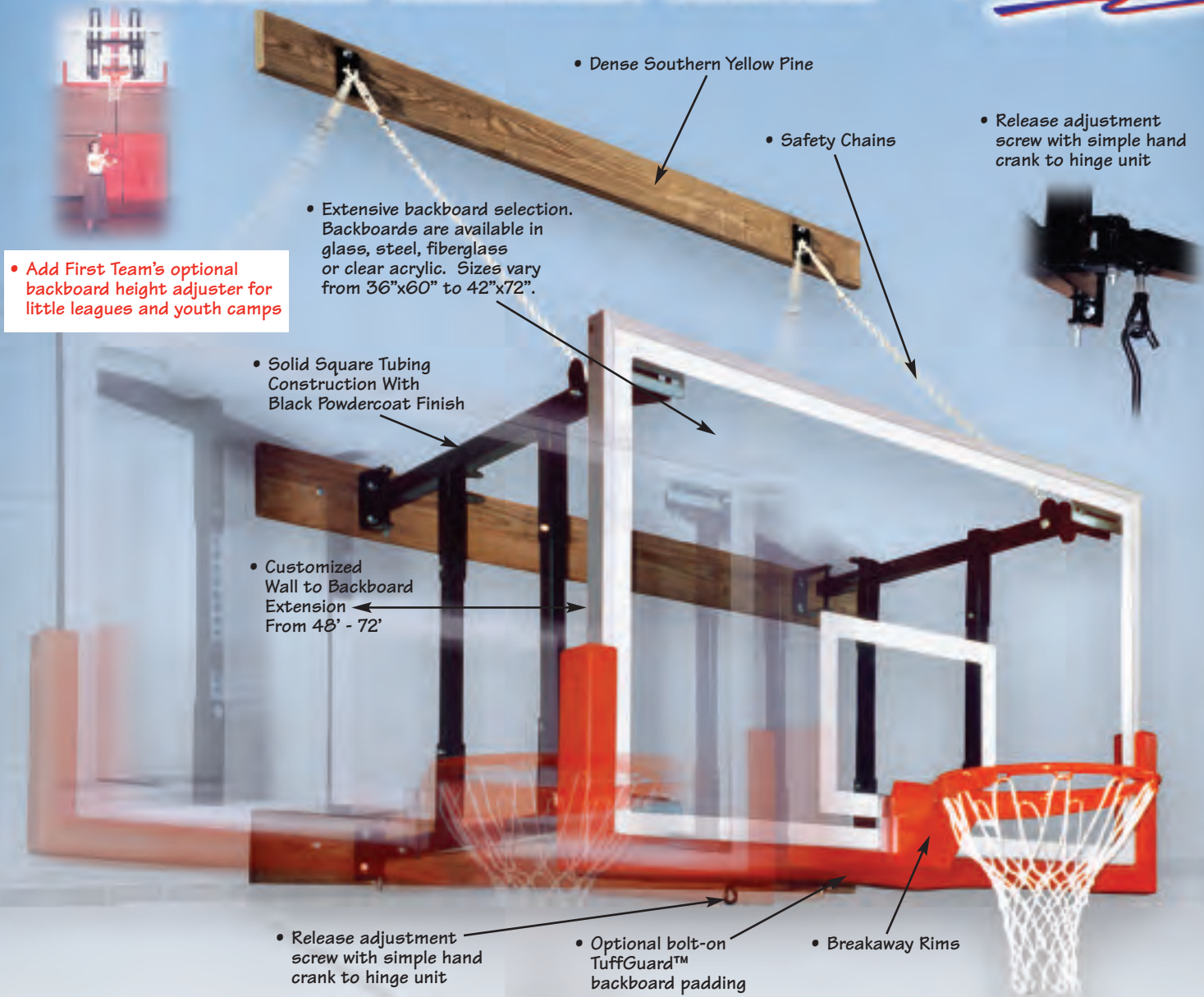

• Add First Team's optional backboard height adjuster for little leagues and youth camps

- Dense Southern Yellow Pine
- Safety Chains
- Release adjustment screw with simple hand crank to hinge unit
- Extensive backboard selection. Backboards are available in glass, steel, fiberglass or clear acrylic. Sizes vary from 36"x60" to 42"x72".
- Solid Square Tubing Construction With Black Powdercoat Finish
- Customized Wall to Backboard Extension From 48" - 72"
- Release adjustment screw with simple hand crank to hinge unit
- Optional bolt-on TuffGuard™ backboard padding
- Breakaway Rims

The FoldaMount46 side-folding wall mount structure simplifies the task of ordering and installing top quality side-fold wall-mounted basketball systems.

When your facility requires that the basketball goals be folded against the wall to make room for volleyball or other activities, call on First Team's FoldaMount46 series. The unit swings left or right for storage close to the wall without tools or ladders! Ordering is simple. Simply choose the FoldaMount46 package that best suits your needs and budget.

No more guesswork about which backboard and rim to choose. Compatibility is guaranteed!

Installing the FoldaMount46 is simple as well. The FoldaMount46 is specifically designed to provide wall-to-backboard extension distances from 4' to 6' during installation. This allows the unit to be "fine-tuned" to match the court markings on the floor. You will avoid costly rework and field modifications commonly caused by measurement errors.

Folding the unit is easy. Simply use the adjustment crank provided with

each unit to loosen the adjustment screw. Grab the rim with the hook on the crank and tug on the unit to slide it against the wall. Then tighten the adjustment screw to secure the unit. Reverse the process to set up for play! It's that simple!

Pick from First Team's broad array of package configurations to satisfy the needs of your facility. Remember, for additional safety, First Team offers optional bolt-on padding for most FoldaMount46 packages.

All FoldaMount46 packages come with a Lifetime Limited Warranty.

FOLDAMOUNT 46 PACKAGE OPTIONS

**FOLDAMOUNT 46
VICTORY**



**FOLDAMOUNT 46
TRIUMPH**



**FOLDAMOUNT 46
SELECT**



**FOLDAMOUNT 46
PRO**



Shown with optional bolt-on
TuffGuard™ backboard padding

- FT2030 FoldaMount 46 System
- FT234 42"x72" Glass Backboard
- FT190 Competition Breakaway Goal
- Approx. Shipping Weight: 503 lbs.

- FT2030 FoldaMount 46 System
- FT235 42"x72" Glass Backboard
- FT192 Competition Breakaway Goal
- Approx. Shipping Weight: 513 lbs.

- FT2030 FoldaMount 46 System
- FT36 Silver Support Structure
- FT220 36"x60" Acrylic Backboard
- FT186 Heavy Duty Flex Goal
- Approx. Shipping Weight: 400 lbs.

- FT2030 FoldaMount 46 System
- FT36 Silver Support Structure
- FT230 36"x60" Glass Backboard
- FT186 Heavy Duty Flex Goal
- Approx. Shipping Weight: 445 lbs.

**FOLDAMOUNT 46
SUPREME**



**FOLDAMOUNT 46
ADVANTAGE**



**FOLDAMOUNT 46
MAVERICK**



- FT2030 FoldaMount 46 System
- FT42 Silver Support Structure
- FT222 42"x72" Acrylic Backboard
- FT186 Heavy Duty Flex Goal
- Approx. Shipping Weight: 445 lbs.

- FT2030 FoldaMount 46 System
- FT233 39"x54" Glass Backboard
- FT190 Competition Breakaway Goal
- Approx. Shipping Weight: 433 lbs.

- FT2030 FoldaMount 46 System
- FT231 40"x54" Glass Backboard
- FT186 Heavy Duty Flex Goal
- Approx. Shipping Weight: 463 lbs.

**FOLDAMOUNT 46
AGGRESSOR**



**FOLDAMOUNT 46
MAGNUM**



**FOLDAMOUNT 46
REBOUND**



**FOLDAMOUNT 46
PERFORMANCE**



- FT2030 FoldaMount 46 System
- FT260B 42"x60" Steel Backboard
- FT186 Heavy Duty Flex Goal
- Approx. Shipping Weight: 463 lbs.

- FT2030 FoldaMount 46 System
- FT265B 42"x72" Steel Backboard
- FT186 Heavy Duty Flex Goal
- Approx. Shipping Weight: 503 lbs.

- FT2030 FoldaMount 46 System
- FT275 39"x54" Fiberglass Backboard
- FT186 Heavy Duty Flex Goal
- Approx. Shipping Weight: 420 lbs.

- FT2030 FoldaMount 46 System
- FT280 42"x72" Fiberglass Backboard
- FT186 Heavy Duty Flex Goal
- Approx. Shipping Weight: 456 lbs.

www.firstteaminc.com

First Team, Inc. • Hutchinson, Kansas • Toll-Free 1-800-649-3688



TUFFGUARD™

BOLT-ON COMPETITION BACKBOARD PADS

- Specify Color Code

FT72C-XX ▶

- Fits all manufacturers 72" backboards
- Meets or exceeds all NCAA, FIBA and NFHS specifications
- Available in 16 Colors
- Molded-In Goal Relief
- Center Pin Connectors
- Attachment Hardware Included
- One Set Covers One Backboard
- All First Team Competition Backboards are Pre-Drilled for Easy TuffGuard Installation
- Superior to Glue-On, Vinyl-Dipped or Other Safety Pads
- Approx. Shipping Weight: 15 lbs.

- New Contoured Shape Reduces Ball Interference



- Molded-In Goal Relief
- Superior Pins Style Center Connectors

Available Colors and Color Codes

(Specify Color by Color Code When Ordering)

RY Royal Blue	SC Scarlet	GL Gold	PR Purple	KG Kelly Green	BK Black	CB Columbia Blue	MR Maroon	GR Grey	NB Navy Blue	OR Orange	FG Forest Green	BR Brick Red	SO Sienna Orange	DG Desert Gold	SB Saddle Brown
-------------------------	----------------------	-------------------	---------------------	--------------------------	--------------------	----------------------------	---------------------	-------------------	------------------------	---------------------	---------------------------	------------------------	----------------------------	--------------------------	---------------------------

BACKBOARD HEIGHT ADJUSTERS

FT300 ▶

- Provides infinite adjustment from 10' down to 8'
- Works with any backboard that has 20"x35" spaced mounting brackets
- Operates easily from floor level with simple hand crank
- Only height adjuster warranted against dunking
- Safer than typical "hang-on" type auxiliary goal structures
- A must for any school or recreation center running youth programs
- 10-Year Superior Warranty
- Approx. Shipping Weight: 125 lbs.



FT310

(Not Shown)

- Provides infinite adjustment from 10' down to 8'
- Works with any backboard that has 36"x62" spaced mounting brackets
- Operates easily from floor level with simple hand crank
- Only height adjuster warranted against dunking
- Safer than typical "hang-on" type auxiliary goal structures
- A must for any school or recreation center running youth programs
- 10-Year Superior Warranty
- Approx. Shipping Weight: 150 lbs.



VICTORY UPGRADE PACKAGE



- FT234 Competition Glass Backboard
- FT190 Breakaway Rim
- FT72C TuffGuard Bolt-On Padding (Any Color)
- Approx. Shipping Weight: 235 lbs.

TRIUMPH UPGRADE PACKAGE



- FT235 Competition Glass Backboard
- FT194TA Breakaway Rim
- FT72C TuffGuard Bolt-On Padding (Any Color)
- Approx. Shipping Weight: 245 lbs.

CONTENDER UPGRADE PACKAGE



- FT239 Competition Glass Backboard
- FT190 Breakaway Rim
- FT72C TuffGuard Bolt-On Padding (Any Color)
- Approx. Shipping Weight: 265 lbs.

TRADITION UPGRADE PACKAGE



- FT236 Competition Glass Backboard
- FT190 Breakaway Rim
- FT72C TuffGuard Bolt-On Padding (Any Color)
- Approx. Shipping Weight: 255 lbs.

GYMNASIUM UPGRADE PACKAGES

When it's time to upgrade your existing backboards and rims, trust First Team to provide top-notch equipment for your facility. Choosing from one of our four package options saves money and guarantees compatibility of all components. All product is manufactured in the USA and backed by First team's unmatched warranties!

COMPETITOR UPGRADE PACKAGE



- FT240 Competition Glass Backboard
- FT194TA Breakaway Rim
- FT72C TuffGuard Bolt-On Padding (Any Color)
- Approx. Shipping Weight: 275 lbs.

COLOSSUS UPGRADE PACKAGE



- FT241 Competition Glass Backboard
- FT190 Breakaway Rim
- FT72C TuffGuard Bolt-On Padding (Any Color)
- Approx. Shipping Weight: 275 lbs.



FullTilt™
180° Breakaway
Action



FT196

- Breakaway action from any angle
- Long lasting positive lock mechanism
- Durable continuous net-locks
- Fits all standard backboards
- Durable powdercoat finish
- Excellent goal for college or high school use
- Meets all NCAA and H.S. specifications
- Anti-whip net and mounting hardware included
- 8-Year Superior Warranty
- Approx. Shipping Weight: 26 lbs.

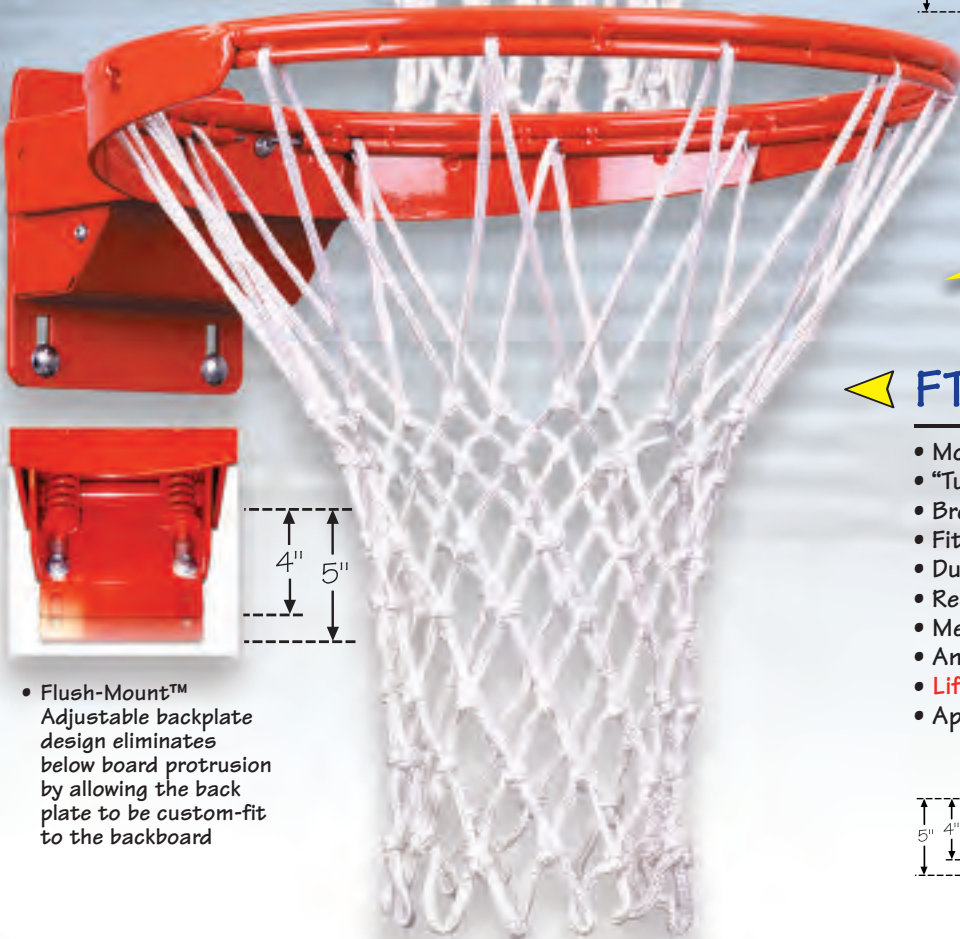
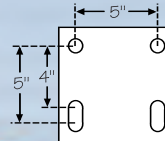

FT194TA

- Most durable positive lock mechanism available
- "Tuff-Tie" tubular net hanger design
- Breakaway tension adjustable from 170-230 lbs.
- Fits all standard backboards
- Durable powdercoat finish
- Recommended for the most demanding conditions
- Meets all NCAA and H.S. specifications
- Anti-whip net and mounting hardware included
- **Lifetime Superior Warranty** (Indoor Use Only)
- Approx. Shipping Weight: 26 lbs.

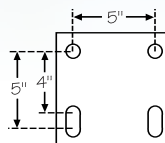

**The First and Only
Breakaway Rim with
a Lifetime Warranty!**

- **Flush-Mount™**
Adjustable backplate design eliminates below board protrusion by allowing the back plate to be custom-fit to the backboard

BREAKAWAY GOALS

FT192TA ▶

- Long lasting positive lock mechanism
- "Tuff-Tie" tubular net hanger design
- Breakaway tension fully adjustable from 170-230 lbs.
- Fits all standard backboards
- Durable powdercoat finish
- Excellent goal for college or high school competition
- Meets all NCAA and H.S. specifications
- Anti-whip net and mounting hardware included
- 5-Year Superior Warranty
- Approx. Shipping Weight: 26 lbs.



- Flush-Mount™
Adjustable backplate design eliminates below board protrusion by allowing the back plate to be custom-fit to the backboard

FT192 ▶

- Long lasting positive lock mechanism
- Durable continuous net-locks
- Fits all standard backboards
- Durable powdercoat finish
- Excellent goal for college or high school use
- Meets all NCAA and H.S. specifications
- Anti-whip net and mounting hardware included
- 2-Year Superior Warranty
- Approx. Shipping Weight: 26 lbs.

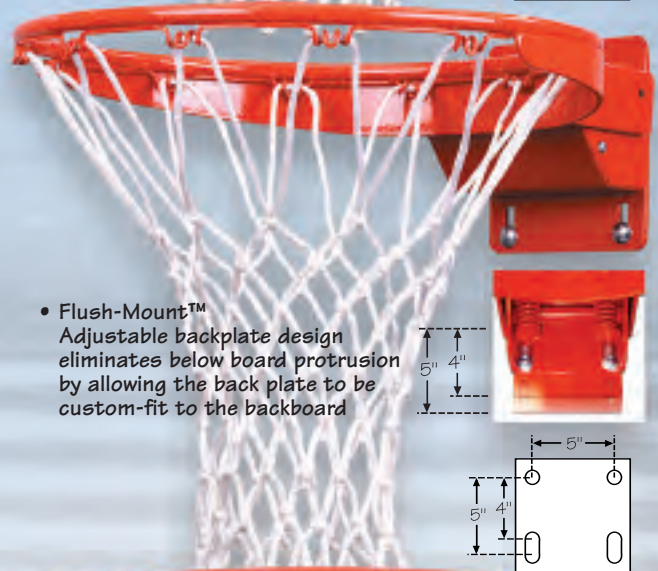

- Flush-Mount™
Adjustable backplate design eliminates below board protrusion by allowing the back plate to be custom-fit to the backboard

FT190 ▶

- Durable breakaway goal built for economy
- Continuous net-locks
- Fits all standard backboards
- Powdercoat finish
- Great goal for Junior High, YMCA, Rec Center or Church
- Meets all NCAA and H.S. specifications
- Anti-whip net and mounting hardware included
- 1-Year Limited Warranty
- Approx. Shipping Weight: 23 lbs.



◀ FT186

- Heavy duty flex goal
- See page 60 for details



COMPETITION GLASS BACKBOARDS



FT235

- Official 42"x72" tempered glass backboard
- Rim mount design eliminates goal-to-glass contact
- Guaranteed to be unbreakable during play
- Built-in goal leveling feature
- Board is pre-drilled for FT72C TuffGuard backboard padding (goal and padding not included)
- Cushioned 1/2" tempered glass
- Regulation white border and shooters square fired into glass
- Meets all NCAA and H.S. specifications
- **Lifetime Superior Warranty**
- Approx. Shipping Weight: 200 lbs.

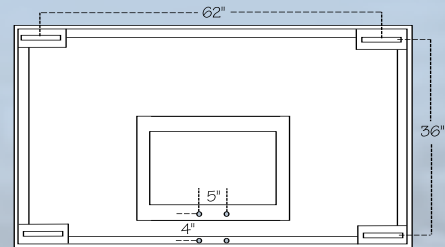

FT240

- Official 42"x72" tempered glass conversion backboard
- Mounts directly to structures where fan-shaped boards previously existed
- Unbreakable design like our popular FT235 board
- Built-in goal leveling feature
- Board is pre-drilled for FT72C TuffGuard backboard padding (goal and padding not included)
- Cushioned 1/2" tempered glass
- Regulation white border and shooters square fired into glass
- Meets all NCAA and H.S. specifications
- **Lifetime Superior Warranty**
- Approx. Shipping Weight: 230 lbs.

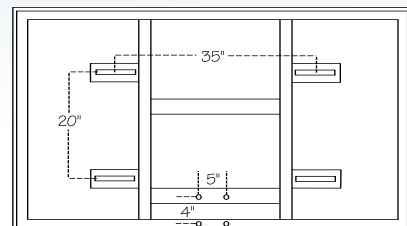

COMPETITION GLASS BACKBOARDS



FT234

- Official 42"x72" tempered glass backboard
- Board is pre-drilled for FT72C TuffGuard backboard padding (goal and padding not included)
- Cushioned 1/2" tempered glass
- Regulation white border and shooters square fired into glass
- Great for use where rough play is not expected
- Meets all NCAA and H.S. specifications
- **10-Year Limited Warranty**
- Approx. Shipping Weight: 190 lbs.

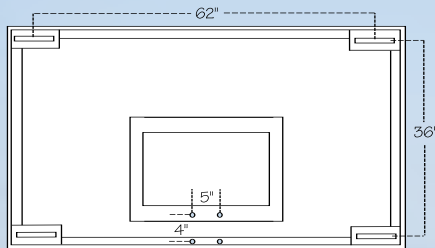

FT239

- Official 42"x72" tempered glass conversion backboard
- Mounts directly to structures where fan-shaped boards previously existed
- Board is pre-drilled for FT72C TuffGuard backboard padding (goal and padding not included)
- Cushioned 1/2" tempered glass
- Regulation white border and shooters square fired into glass
- Great for use where rough play is not expected
- Meets all NCAA and H.S. specifications
- **10-Year Limited Warranty**
- Approx. Shipping Weight: 220 lbs.

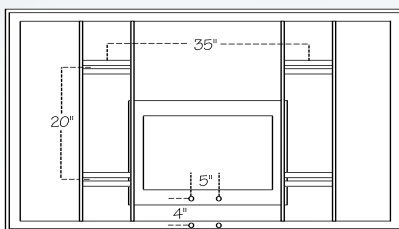

OTHER GYMNASIUM BACKBOARDS



FT236

- Traditional 48"x72" competition glass backboard
- Cushioned 1/2" tempered glass
- Regulation white border and shooters square fired into glass
- Meets all NCAA and H.S. specifications
- 10-Year Limited Warranty
- Approx. Shipping Weight: 210 lbs.

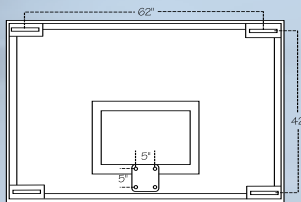

Note: Traditional 48"x72" backboards are still used in many high schools and colleges today. The FT236 should be purchased for replacement only. For new installations or complete gym conversions, First Team recommends the newer 42"x72" backboards because of reduced risk of player injury due to contact with the board.

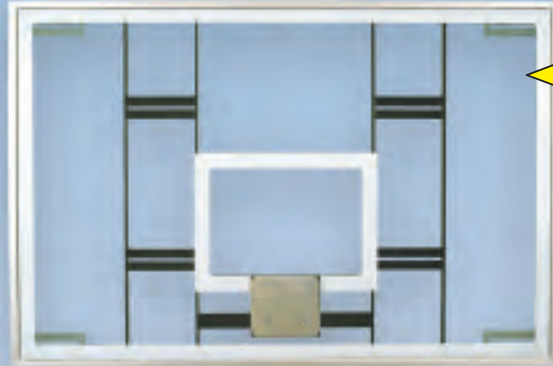

FT241

- Traditional 48"x72" competition glass backboard
- Mounts directly to structures where fan-shaped boards previously existed
- Cushioned 1/2" tempered glass
- Regulation white border and shooters square fired into glass
- Meets all NCAA and H.S. specifications
- 10-Year Limited Warranty
- Approx. Shipping Weight: 230 lbs.

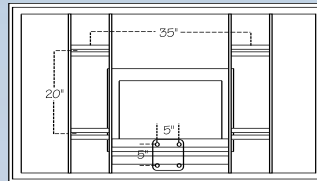

Note: Traditional 48"x72" backboards are still used in many high schools and colleges today. The FT241 should be purchased for replacement only. For new installations or complete gym conversions, First Team recommends the newer 42"x72" backboards because of reduced risk of player injury due to contact with the board.



FT231

- Down-sized 40"x54" tempered glass backboard
- Same quality construction as our FT234 competition board
- Cushioned 1/2" tempered glass
- Heavy duty aluminum framework
- White border and shooters square
- Great for use anywhere regulation sized boards are not needed
- 10-Year Limited Warranty
- Approx. Shipping Weight: 150 lbs.

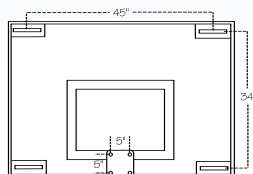

FT233

- Traditional fan-shaped 39"x54" competition glass backboard
- Cushioned 1/2" tempered glass
- Heavy duty aluminum framework
- Regulation white border and shooters square fired into glass
- Meets all NCAA and H.S. specifications
- 10-Year Limited Warranty
- Approx. Shipping Weight: 120 lbs.

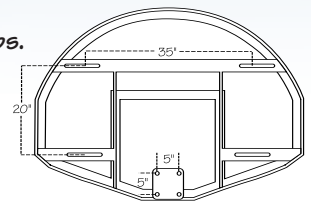

OTHER GYMNASIUM BACKBOARDS



FT220H ▶

- 36"x60" acrylic backboard
- All weather 1/2" thick clear acrylic
- Heavy anodized aluminum framework
- FT36HFM H-Frame provides rim support
- 10-Year Limited Warranty
- Approx. Shipping Weight: 100 lbs.

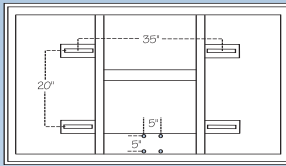

FT222H ▶

- 42"x72" acrylic backboard
- All weather 1/2" thick clear acrylic
- Competition grade anodized alum. frame
- FT42HFM H-Frame provides rim support
- 10-Year Limited Warranty
- Approx. Shipping Weight: 145 lbs.

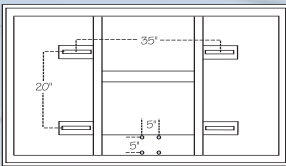

FT230H ▶

- 36"x60" Response™ tempered glass backboard
- All weather 3/8" thick tempered glass
- Competition grade aluminum framework
- Provides gymnasium quality ball reaction off board
- FT36HFM H-Frame provides rim support
- 10-Year Limited Warranty
- Approx. Shipping Weight: 145 lbs.

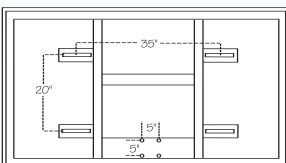

the SIX-SHOOTER

6-IN-1 YOUTH TRAINING GOAL

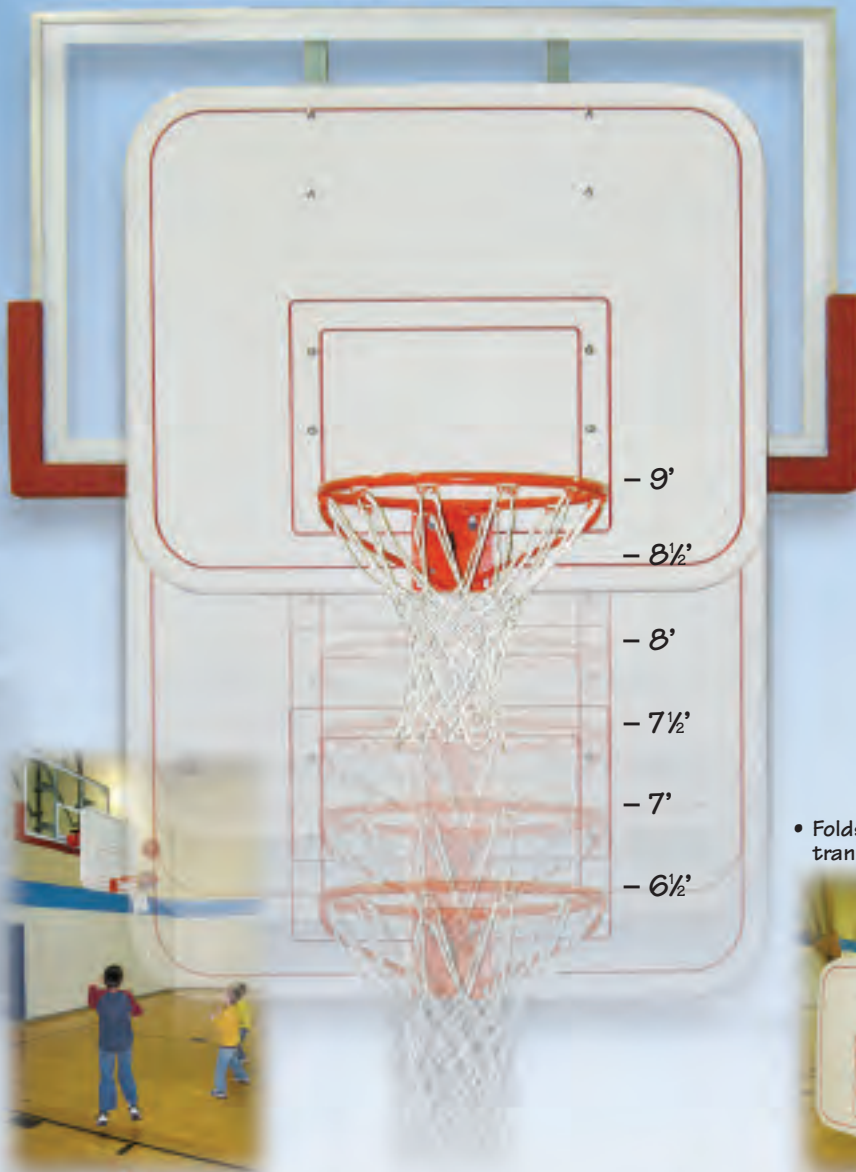

First Team's Six-Shooter youth training goal is the most versatile youth training goal on the market! Only Six-Shooter is capable of being configured for six different rim heights. When installed on a standard 10' high goal, Six-Shooter can be set up for 6½', 7', 7½', 8', 8½', and 9' rim heights. Requiring only two minutes to change unit from one goal height to another, Six-Shooter accommodates programs running multiple leagues at different age levels. No tools required!

Six-Shooter will fit any style rim, regardless of age or manufacturer. A Six-Shooter unit lowers rim and moves rim 24" closer to the free-throw line. A regulation size rim is included. High impact white ABS plastic backboard measures 39" high and 48" wide and has red shooter's square and border machined into face. Entire system weight is 49# allowing one person standing no more than 24" above playing surface to quickly and easily attach unit to a 10' high goal. Unit is not suitable for dunking or hanging from goal. Entire unit is covered by a Lifetime Limited Warranty.

• Folds easily for transport & storage

• 49# lifting weight

• Adjusts to 6 playing heights



the BLOCK-AID REBOUNDER



First Team's Block-Aid rebounder training aid requires no tools or ladders to install. Simply toss it into place or lift up with a broom handle. Tip out to remove or use broom handle to remove. The Block-Aid is molded of lightweight urethane and will not damage floors or injure players. Get the most out of your practice sessions. Block-Aid will improve rebounding skills without wasting precious time on made shots. Ball rebounds off naturally in all directions. Lifetime Limited Warranty. Approx. shipping weight 8 lbs.

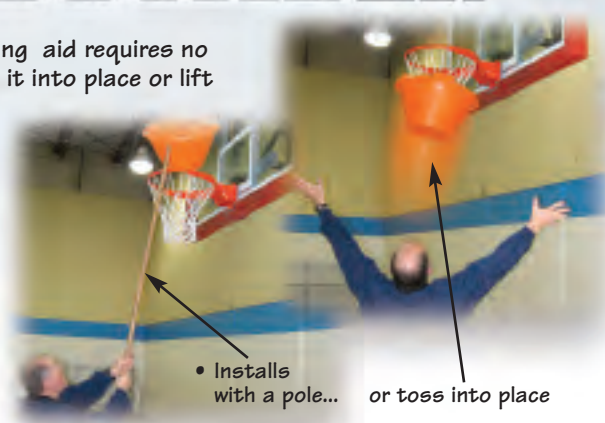

• Installs with a pole... or toss into place

the **BALL HOG™**
PREMIUM BALL CARRIER



FT24 ▶

• Holds up to 24 Mens or Womens Basketballs

• Tote Handle for Easy Transport

• Durable Powder Coated Steel Construction

• FREE LTR24 Lettering Upon Request

First Team's Ball Hog is the last ball carrier you'll ever need to buy!

LIFETIME SUPERIOR WARRANTY!

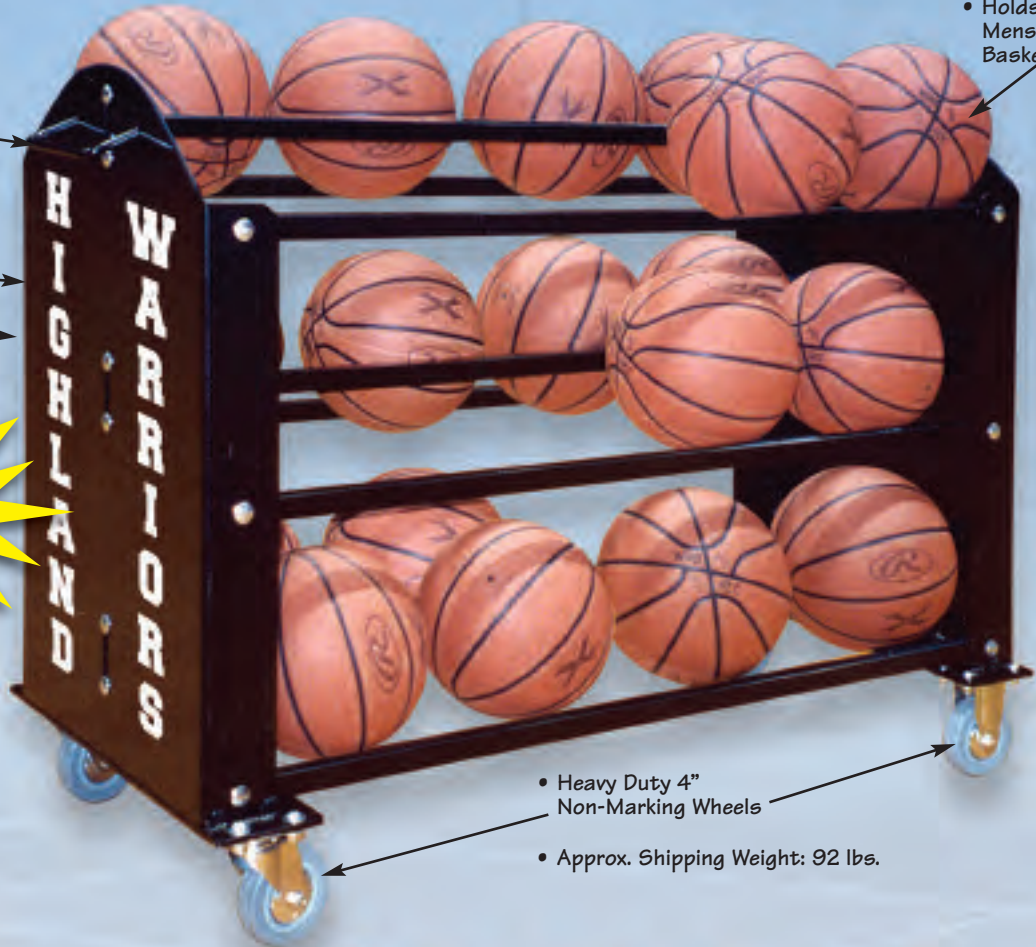

• Heavy Duty 4" Non-Marking Wheels

• Approx. Shipping Weight: 92 lbs.

FT15 ▶

- Economy Ball Carrier
- Holds up to 12 Men's or Women's Basketballs
- Swivel casters on all four corners
- Value pricing
- 1-Year Limited Warranty
- Approx. Shipping Weight: 13 lbs.



www.firstteaminc.com

First Team, Inc. • Hutchinson, Kansas • Toll-Free 1-800-649-3688

HIGH IMPACT™

GRAPHIC WALL PADDING



FT450-GPH

- Minimum Order of 4 Panels
- 2' x 6' Panel
- 1-Year Limited Warranty
- Approx. Shipping Weight: 26 lbs./Panel

FT458-GPH

- Minimum Order of 4 Panels
- 2' x 8' Panel
- 1-Year Limited Warranty
- Approx. Shipping Weight: 36 lbs./Panel

FT455-GPH

- Odd Sized Panel Specify Size Up To 2' x 8'
- 1-Year Limited Warranty
- Priced Per Sq. Ft.

Energize your facility with First Teams' High Impact graphic wall padding! First Team's unique digital printing process allows us to print any image you desire on our safety pads. Our graphics team will work with you to develop the perfect look for your facility. We can use customer supplied artwork (see artwork specifications) or develop your art from scratch. High Impact pads are priced including one hour of in house art design. Two inch thick foam pads are available in standard 2'x6' and 2'x8' sizes. Odd size panels are available and are priced per square foot. Pads are mounted permanently to the wall through 7/16" thick plywood backing. A 1" lip top and bottom is provided for wall attachment. Fastening hardware is not provided. If cutouts are required for outlets, etc. simply order field cutout FT449 shown, specify size and color. Common applications require 8 panels, 16' to protect the 12' wide free throw lane. 1-Year Limited Warranty. Call for quote if Class "A" fire rated pads are required.



BODYGUARD™

PROTECTIVE WALL PADDING

First Team's BodyGuard wall padding is a great choice anywhere there is potential for participant injury due to wall collision. BodyGuard wall padding is available in 16 colors and includes 2" thick foam wrapped in a 14 oz. vinyl covering. Panels are available in two standard sizes 2'x6' and 2'x8' as well as odd size panels for custom situations. Pads are mounted permanently to the wall through 7/16" thick plywood backing. A 1" lip top and bottom is provided for wall attachment. Fastening hardware is not provided. If cutouts are required for outlets, etc. simply order field cutout FT449 shown, specify size and color. Common applications require 8 panels, 16' to protect the 12' wide free throw lane. 1-Year Limited Warranty. Call for quote if Class "A" fire rated pads are required.

FT450-XX

- 2' x 6' Panel
- 1-Year Limited Warr.
- Approx. Shipping Weight: 26 lbs./Panel

FT458-XX

- 2' x 8' Panel
- 1-Year Limited Warr.
- Approx. Shipping Weight: 36 lbs./Panel

FT455-XX

- Odd Sized Panel Size Up To 2' x 8'
- 1-Year Limited Warr.
- Priced Per Sq. Ft.

FT449

- Field Cutout Insert for two-plug outlet (specify color)
- 1-Year Limited Warr.
- App. Ship. Wt: 1 lb.

RY Royal Blue	SC Scarlet	GL Gold	PR Purple	KG Kelly Green	BK Black	CB Columbia Blue	MR Maroon	GR Grey	NB Navy Blue	OR Orange	FG Forest Green	BR Brick Red	SO Sienna Orange	DG Desert Gold	SB Saddle Brown
-------------------------	----------------------	-------------------	---------------------	--------------------------	--------------------	----------------------------	---------------------	-------------------	------------------------	---------------------	---------------------------	------------------------	----------------------------	--------------------------	---------------------------

BodyGuard wall padding is available in these colors. Shades may vary slightly from color chart.

www.firstteaminc.com

First Team, Inc. • Hutchinson, Kansas • Toll-Free 1-800-649-3688

the ROOFMASTER

ADJUSTABLE ROOF/WALLMOUNT SYSTEM



See
Accessories
Section for
Backboard
Padding
Options.

- Selection of various clear acrylic and tempered glass backboards. Sizes vary from 36"x48" to 36"x60".
- Backboard braces for superior backboard rigidity
- Mount on sloped rooftop
- Easy adjustment from the ground with included handle
- Optional bolt-on TuffGuard™ backboard padding available in several colors
- Super strength flex goals are "direct mounted" to eliminate backboard stress
- Mount on vertical wall
- Extension at various heights:
10' height - 38" extension
9' height - 43" extension
8' height - 44" extension
7' height - 38" extension
6' height - 25" extension

The RoofMaster offers infinite adjustability for the customer who has no place for a pole mounted system.

No other system compares to the Roof-Master from First Team. The unit is versatile enough to mount to any roof pitch or vertical wall surface. The RoofMaster is infinitely

adjustable with the industry's widest range of height adjustment. With a simple turn of the hand-crank the RoofMaster offers an adjustment range of up to 4-feet (10' - 6').

An easy-to-read rim height indicator displays the exact height of the rim.

We offer several backboards and

rims with the RoofMaster so you can choose the package that's right for you and your budget.

For player safety, First Team offers optional backboard padding for each RoofMaster system.

Every RoofMaster package comes with a Lifetime Limited Warranty.

ROOFMASTER PACKAGE OPTIONS



ROOFMASTER II

- FT1650 RoofMaster Mount System
- FT210 36"x48" Acrylic Backboard
- FT184 Recreational Flex Goal
- Lifetime Limited Warranty
- Approx. Shipping Weight: 238 lbs.

ROOFMASTER III

- FT1650 RoofMaster Mount System
- FT215 36"x54" Acrylic Backboard
- FT186 Heavy Duty Flex Goal
- Lifetime Limited Warranty
- Approx. Shipping Weight: 248 lbs.

ROOFMASTER SELECT

- FT1650 RoofMaster Mount System
- FT220 36"x60" Acrylic Backboard
- FT186 Heavy Duty Flex Goal
- Lifetime Limited Warranty
- Approx. Shipping Weight: 258 lbs.

ROOFMASTER TURBO

- FT1650 RoofMaster Mount System
- FT216 36"x54" Temp. Glass Bkhd.
- FT186 Heavy Duty Flex Goal
- Lifetime Limited Warranty
- Approx. Shipping Weight: 248 lbs.

ROOFMASTER NITRO

- FT1650 RoofMaster Mount System
- FT221 36"x60" Temp. Glass Bkhd.
- FT186 Heavy Duty Flex Goal
- Lifetime Limited Warranty
- Approx. Shipping Weight: 258 lbs.

www.firstteaminc.com

First Team, Inc. • Hutchinson, Kansas • Toll-Free 1-800-649-3688

the CHAMP

ADJUSTABLE BASKETBALL SYSTEM



- Backboards available in acrylic or glass
- Super strength flex goals are "direct mounted" to eliminate backboard stress
- Optional bolt-on TuffGuard™ backboard padding available in several colors
- Insta-Just™ height adjustment. No need for tools or a ladder. A simple broom handle allows you to adjust rim height from 10'-7"6" in 6" increments.

- Optional all-weather velcro wrap-around post padding for added safety (See padding section for available colors)
- Post is buried 36" below playing surface (FT16 ground sleeve option can be purchased to make post removable)

Now with Lifetime Superior Warranty!

The Champ offers adjustability at an affordable price!

The Champ's 4"x4" 11 ga. steel post is 50% heavier than any goal of its kind. Our one piece post design eliminates wobbling, rusting joints common with sectional type posts.

Our Insta-Just™ height adjustment mechanism allows the Champ to adjust from 10' to 7'6" in six inch increments. To adjust, use a broom handle to release the Insta-Just™ height regulator.

A variety of backboards and rims are offered with the Champ so you can choose the Champ package that's right for you.

For additional safety, pole padding and backboard padding can be added to any Champ package.

Every Champ package comes with a Lifetime Superior Warranty.

- Post to backboard extension distance is 18" with rim at 10' (Extension distance increases as rim height is lowered)

CHAMP PACKAGE OPTIONS



- FT1100 4" Square Post
- FT1200 Champ Arm System
- FT210 36"x48" Acrylic Backboard
- FT184 Recreational Flex Goal
- Lifetime Superior Warranty
- Approx. Shipping Weight: 150 lbs.

- FT1100 4" Square Post
- FT1200 Champ Arm System
- FT215 36"x54" Acrylic Backboard
- FT186 Heavy Duty Flex Goal
- Lifetime Superior Warranty
- Approx. Shipping Weight: 160 lbs.

- FT1100 4" Square Post
- FT1200 Champ Arm System
- FT220 36"x60" Acrylic Backboard
- FT186 Heavy Duty Flex Goal
- Lifetime Superior Warranty
- Approx. Shipping Weight: 170 lbs.

- FT1100 4" Square Post
- FT1200 Champ Arm System
- FT216 36" x 54" Temp. Glass Bkbd.
- FT186 Heavy Duty Flex Goal
- Lifetime Superior Warranty
- Approx. Shipping Weight: 160 lbs.

- FT1100 4" Square Post
- FT1200 Champ Arm System
- FT221 36" x 60" Temp. Glass Bkbd.
- FT186 Heavy Duty Flex Goal
- Lifetime Superior Warranty
- Approx. Shipping Weight: 170 lbs.

the SLAM

ADJUSTABLE BASKETBALL SYSTEM



- Backboards available in acrylic or glass
- Super strength flex goals are "direct mounted" to eliminate backboard stress
- Optional bolt-on TuffGuard™ backboard padding available in several colors
- Springs located in the extension assembly counter balance the weight of the backboard and rim. Adjustment is effortless.
- Optional all-weather velcro wrap-around post padding for added safety (See padding section for available colors)
- Quik-Pin™ height adjustment design makes adjusting the SLAM effortless and safe. Unit adjusts from 10'-7" in 6" increments.
- Post is buried 36" below playing surface (FT16 ground sleeve option can be purchased to make post removable)

Now with Lifetime Superior Warranty!

The Slam offers a unique combination of adjustability, durability and affordability! The Slam includes a heavy 4"x4" 11 ga. steel post. Our one piece post design eliminates the potential for joint deterioration common with sectional posts. The Quik-Pin™ rim height adjustment design makes adjusting the Slam quick and easy. To adjust, simply pull the pin located on the back of the unit, lift the adjustment handle to the desired rim height, replace the pin and you're ready for action. The Slam is adjustable from 10' to 7' in six inch increments. The Slam's spring aided design insures that adjustment is effortless. Various backboards and rims are offered with the Slam so you can choose the Slam package that fits your family. For additional safety, pole padding and backboard padding can be added to any Slam package. Every Slam package comes with a Lifetime Superior Warranty.

• Post to backboard extension distance is 24" with rim at 10' (Extension distance increases as rim height is lowered)

SLAM PACKAGE OPTIONS

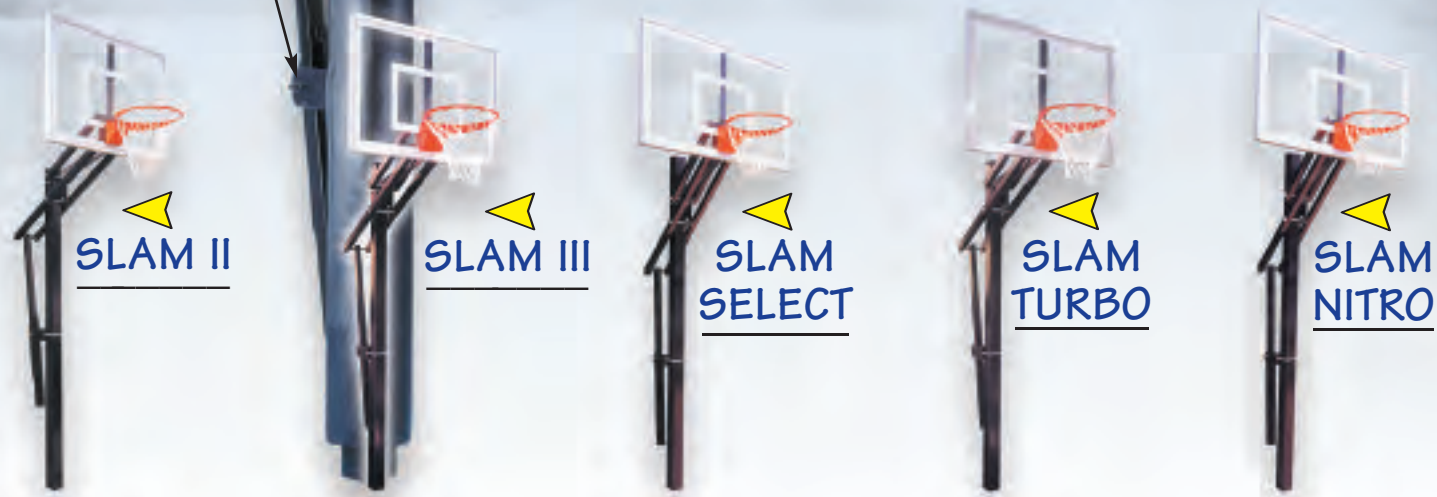

- FT1100 4" Square Post
- FT1250 Slam Arm System
- FT210 36"x48" Acrylic Backboard
- FT184 Recreational Flex Goal
- Lifetime Superior Warranty 🏠
- Approx. Shipping Weight: 195 lbs.

- FT1100 4" Square Post
- FT1250 Slam Arm System
- FT215 36"x54" Acrylic Backboard
- FT186 Heavy Duty Flex Goal
- Lifetime Superior Warranty 🏠
- Approx. Shipping Weight: 205 lbs.

- FT1100 4" Square Post
- FT1250 Slam Arm System
- FT220 36"x60" Acrylic Backboard
- FT186 Heavy Duty Flex Goal
- Lifetime Superior Warranty 🏠
- Approx. Shipping Weight: 215 lbs.

- FT1100 4" Square Post
- FT1250 Slam Arm System
- FT216 36" x 54" Temp. Glass Bkhd.
- FT186 Heavy Duty Flex Goal
- Lifetime Superior Warranty 🏠
- Approx. Shipping Weight: 205 lbs.

- FT1100 4" Square Post
- FT1250 Slam Arm System
- FT221 36" x 60" Temp. Glass Bkhd.
- FT186 Heavy Duty Flex Goal
- Lifetime Superior Warranty 🏠
- Approx. Shipping Weight: 215 lbs.

www.firstteaminc.com

First Team, Inc. • Hutchinson, Kansas • Toll-Free 1-800-649-3688

the

VECTOR

ADJUSTABLE BASKETBALL SYSTEM



**Now with
Lifetime Superior
Warranty!**

- Backboards available in acrylic or glass
- Optional bolt-on TuffGuard™ backboard padding available in several colors
- Springs located in the extension assembly counterbalance the weight of the backboard and rim. Adjustment is effortless.
- Optional all-weather velcro wrap-around post padding for added safety (See padding section for available colors)
- Simple hand crank adjustment easily adjusts rim height from 10' - 7'
- Hand crank is removable
- Post is buried 36" below playing surface. (FT16 ground sleeve option can be purchased to make post removable.)

• Super strength flex goals are "direct mounted" to eliminate any chance of backboard breakage

• Post to backboard extension distance is 32" with rim at 10' (Extension distance increases as rim height is lowered)

The Vector provides the easiest and most economical way to get infinite height adjustment and great performance in one affordable package.

First Team's Vector basketball system includes our heavy one piece 11 ga. 4"x 4" post design that eliminates the risk of joint deterioration common with sectional type posts.

The Vector's unique front-mount EZ Crank is a great choice, especially when a wall or other obstruction makes installing a rear-cranking unit impossible. First Team is the ONLY manufacturer to offer a front-mount EZ Crank with SPRING-ASSIST. Our spring-aided crank design is the easiest to operate in the industry and allows the rim height to quickly be adjusted anywhere from 10' down to 7'. The crank handle is removable to prevent unwanted adjustment. The clear and precise rim height indicator shows the rim height at all times.

All Vector packages include a breakaway goal and net. A variety of backboards are available ranging from 36"x48" to 36"x60". Choose the package that's right for your home court.

For additional safety, pole padding and backboard padding can be added to any Vector package.

Each Vector system comes with a Lifetime Superior Warranty.

VECTOR PACKAGE OPTIONS



VECTOR II

VECTOR III

VECTOR SELECT

VECTOR TURBO

VECTOR NITRO

- FT1100 4" Square Post
- FT1275 Vector Arm System
- FT210 36"x48" Acrylic Backboard
- FT184 Recreational Flex Goal
- Lifetime Superior Warranty
- Approx. Shipping Weight: 195 lbs.

- FT1100 4" Square Post
- FT1275 Vector Arm System
- FT215 36"x54" Acrylic Backboard
- FT186 Heavy Duty Flex Goal
- Lifetime Superior Warranty
- Approx. Shipping Weight: 205 lbs.

- FT1100 4" Square Post
- FT1275 Vector Arm System
- FT220 36"x60" Acrylic Backboard
- FT186 Heavy Duty Flex Goal
- Lifetime Superior Warranty
- Approx. Shipping Weight: 215 lbs.

- FT1100 4" Square Post
- FT1275 Vector Arm System
- FT216 36" x 54" Temp. Glass Bkhd.
- FT186 Heavy Duty Flex Goal
- Lifetime Superior Warranty
- Approx. Shipping Weight: 205 lbs.

- FT1100 4" Square Post
- FT1275 Vector Arm System
- FT221 36" x 60" Temp. Glass Bkhd.
- FT186 Heavy Duty Flex Goal
- Lifetime Superior Warranty
- Approx. Shipping Weight: 215 lbs.

the JAM

ADJUSTABLE BASKETBALL SYSTEM



- Backboards available in acrylic or glass
- Super strength flex goals are "direct mounted" to eliminate any chance of backboard breakage
- Optional bolt-on TuffGuard™ backboard padding available in several colors
- Springs located in the extension assembly counterbalance the weight of the backboard and rim. Adjustment is effortless.
- Optional all-weather velcro wrap-around post padding for added safety (See padding section for available colors)
- Post is buried 36" below playing surface. (FT16 ground sleeve option can be purchased to make post removable.)

Now with Lifetime Superior Warranty!

See Accessories Section for Backboard & Pole Padding Options.

- Post to backboard extension distance is 24" with rim at 10' (Extension distance increases as rim height is lowered)
- Simple hand crank adjustment easily adjusts rim height from 10' - 7"

The Jam offers infinite height adjustability at a price to suit any budget.

First Team's Jam basketball system includes our heavy 11ga. 4"x4" post design that eliminates the risk of joint deterioration common with sectional type posts.

Our spring-aided EZ-Crank™ allows effortless rim height adjustment anywhere from 10' down to 7'. The rim height indicator located on the back of the unit accurately shows rim height.

All Jam packages include a breakaway goal and a net. A variety of backboards are available, ranging in size from 36"x48" to 36"x60". Choose the package that best suits your court.

For additional safety, pole padding and backboard padding can be added to any Jam package.

Every Jam package comes with a Lifetime Superior Warranty.

JAM PACKAGE OPTIONS



- FT1100 4" Square Post
- FT1300 Jam Arm System
- FT210 36"x48" Acrylic Backboard
- FT184 Recreational Flex Goal
- Lifetime Superior Warranty
- Approx. Shipping Weight: 195 lbs.

- FT1100 4" Square Post
- FT1300 Jam Arm System
- FT215 36"x54" Acrylic Backboard
- FT186 Heavy Duty Flex Goal
- Lifetime Superior Warranty
- Approx. Shipping Weight: 205 lbs.

- FT1100 4" Square Post
- FT1300 Jam Arm System
- FT220 36"x60" Acrylic Backboard
- FT186 Heavy Duty Flex Goal
- Lifetime Superior Warranty
- Approx. Shipping Weight: 215 lbs.

- FT1100 4" Square Post
- FT1300 Jam Arm System
- FT216 36" x 54" Temp. Glass Bkhd.
- FT186 Heavy Duty Flex Goal
- Lifetime Superior Warranty
- Approx. Shipping Weight: 205 lbs.

- FT1100 4" Square Post
- FT1300 Jam Arm System
- FT221 36" x 60" Temp. Glass Bkhd.
- FT186 Heavy Duty Flex Goal
- Lifetime Superior Warranty
- Approx. Shipping Weight: 215 lbs.

www.firstteaminc.com

First Team, Inc. • Hutchinson, Kansas • Toll-Free 1-800-649-3688

the ATTACK

ADJUSTABLE BASKETBALL SYSTEM



- Extensive backboard selection
- All First Team goals are "direct mounted" to eliminate backboard breakage when players hang on the rim.
- Optional all-weather velcro wrap-around post padding for added safety (See padding section for available colors)
- Unique anchor system allows perfect pole leveling and easy pole removal if you move.
- Spring Assist™ makes goal adjustments effortless. Rim height indicator shows exact height.
- EZ Crank™ allows infinite height adjustment from 10' to 6'6"
- Optional TuffGuard™ bolt-on backboard padding available in several colors
- Post to backboard extension distance is 36" with rim at 10' (Extension distance increases as rim height is lowered)

Stainless steel EZ Crank™! Ensures lifelong performance!

The Attack offers infinite adjustability and maximum durability all rolled into one!

The Attack's 4" square post is 3/16" thick. That's 50% heavier than any other goal in its category. The bolt down anchor system allows you to take the goal with you when you move.

Our EZ-Crank™ adjustment means players of any age, size or ability can change the rim height. To adjust, simply turn the crank handle. The Attack is infinitely adjustable from 10' down to 6'6". The rim height indicator shows the height of the rim.

First Team developed the "Spring Assist" which reduces the effort required to crank the goal. This is particularly beneficial for families with young children adjusting the unit.

We offer a large selection of backboards and rims with the Attack so you can customize the unit to suit your needs and style of play. Our Response™ tempered glass backboards offer the same look and authentic ball rebound enjoyed by college and professional players.

For additional safety, pole padding and backboard padding are available for most Attack packages.

All Attack packages have a Lifetime Superior Warranty.

ATTACK PACKAGE OPTIONS



- | | | | | | |
|-------------------------------------|-------------------------------------|-------------------------------------|-------------------------------------|-------------------------------------|-------------------------------------|
| • FT1400 Attack Pole System | • FT1400 Attack Pole System | • FT1400 Attack Pole System | • FT1400 Attack Pole System | • FT1400 Attack Pole System | • FT1400 Attack Pole System |
| • FT210 36"x48" Acrylic Bkbd. | • FT215 36"x54" Acrylic Bkbd. | • FT220 36"x60" Acrylic Bkbd. | • FT225 36"x54" Temp. Glass Bkbd. | • FT230 36"x60" Temp. Glass Bkbd. | • FT256 36"x60" Steel Bkbd. |
| • FT184 Recreational Flex Goal | • FT186 Heavy Duty Flex Goal | • FT186 Heavy Duty Flex Goal | • FT186 Heavy Duty Flex Goal | • FT186 Heavy Duty Flex Goal | • FT172D Unbreakable Fixed Goal |
| • Lifetime Superior Warranty | • Lifetime Superior Warranty | • Lifetime Superior Warranty | • Lifetime Superior Warranty | • Lifetime Superior Warranty | • Lifetime Superior Warranty |
| • Approx. Shipping Weight: 275 lbs. | • Approx. Shipping Weight: 285 lbs. | • Approx. Shipping Weight: 295 lbs. | • Approx. Shipping Weight: 335 lbs. | • Approx. Shipping Weight: 345 lbs. | • Approx. Shipping Weight: 340 lbs. |

the FORCE

ADJUSTABLE BASKETBALL SYSTEM



- Extensive backboard selection
- All First Team goals are "direct mounted" to eliminate backboard breakage when players hang on the rim.
- Optional bolt-on TuffGuard™ backboard padding available in several colors
- Large welded base support gussets for maximum post rigidity
- Unique anchor system allows perfect pole leveling and easy pole removal if you move.
- Optional all-weather velcro wrap-around post padding for added safety (See padding section for available colors)
- Our trademarked Spring Assist™ aids crank, making goal adjustments effortless. The rim height indicator shows exact height of basket.
- EZ Crank™ adjustment allows infinite height adjustment from 10' to 6'6"

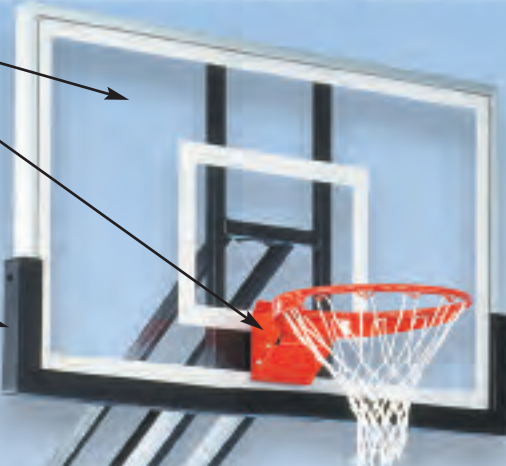

See Accessories Section for Backboard & Pole Padding Options.

• Post to backboard extension distance is 48" with rim at 10' (Extension distance increases as rim height is lowered)

• Stainless steel EZ Crank™ Ensures lifelong performance!

The Force offers infinite adjustability, exceptional rigidity and maximum durability for those serious about basketball!

The Force's tough 5" square, 3/16" thick vertical post and dual-strut extension arm make this system a real powerhouse. The bolt down anchor system allows you to take the goal with you when you move.

Our EZ-Crank™ adjustment means players of any age, size or ability can change the rim height. To adjust, simply turn the crank handle. The Force is infinitely adjustable from 10' down to 6'6". The rim height indicator shows the height of the rim.

The unit features our "Spring-Assist" which reduces the effort required to crank the goal. This is particularly beneficial for families with young children adjusting the unit.

First Team offers a large selection of backboards and rims with the Force. Choose a Force package with one of our Response™ tempered glass backboards if you are wanting authentic gymnasium style ball reaction off the board.

For additional safety, pole padding and backboard padding are available for most Force packages.

Every Force package comes with a Lifetime Superior Warranty.

FORCE PACKAGE OPTIONS



- FT1500 Force Pole System
- FT215 36"x54" Acrylic Backboard
- FT186 Heavy Duty Flex Goal
- Lifetime Superior Warranty
- Approx. Shipping Weight: 305 lbs.

- FT1500 Force Pole System
- FT220 36"x60" Acrylic Backboard
- FT186 Heavy Duty Flex Goal
- Lifetime Superior Warranty
- Approx. Shipping Weight: 315 lbs.

- FT1500 Force Pole System
- FT225 36"x54" Temp. Glass Bkdb.
- FT186 Heavy Duty Flex Goal
- Lifetime Superior Warranty
- Approx. Shipping Weight: 355 lbs.

- FT1500 Force Pole System
- FT230 36"x60" Temp. Glass Bkdb.
- FT186 Heavy Duty Flex Goal
- Lifetime Superior Warranty
- Approx. Shipping Weight: 365 lbs.

- FT1500 Force Pole System
- FT230 36"x60" Steel Bkdb.
- FT1720 Unbreakable Fixed Goal
- Lifetime Superior Warranty
- Approx. Shipping Weight: 360 lbs.

www.firstteaminc.com

First Team, Inc. • Hutchinson, Kansas • Toll-Free 1-800-649-3688

the TITAN

ADJUSTABLE BASKETBALL SYSTEM



- Extensive backboard selection
- Optional bolt-on TuffGuard™ backboard padding available in several colors
- Unique anchor system allows perfect pole leveling and easy pole removal if you move.
- Optional all-weather velcro wrap-around post padding for added safety (See padding section for available colors)
- Our trademarked Spring Assist™ aids the crank, making goal adjustments effortless. The rim height indicator shows exact height of basket.

FREE!
LTR 78
Post Pad Lettering
Upon Request
With Purchase of
Complete System

- EZ Crank™ adjustment allows infinite height adjustment from 10' to 6'6"

- All First Team goals are "direct mounted" to eliminate backboard breakage when players hang on the rim.
- Post to backboard extension distance is 48" with rim at 10' (Extension distance increases as rim height is lowered)

• Stainless steel EZ Crank™! Ensures lifelong performance!

The Titan offers infinite adjustability, maximum rigidity, maximum durability and performs like it came straight out of the arena!

The Titan's massive 6" square, 3/16" thick vertical post and extra heavy-duty dual-strut extension arm provide the toughest, most rigid standard in the industry. The post is set back 4 feet from the backboard to maximize safety. The bolt down anchor footing allows you to easily relocate the unit if you move.

Our EZ-Crank™ adjustment means players of any age, size or ability can change the rim height. To adjust, simply turn the crank handle. The Titan is infinitely adjustable from 10' down to 6'6". The rim height indicator shows the height of the rim.

Our "Double Spring-Assist" makes raising and lowering the goal easier even with our regulation size 42"x72" backboards.

First Team offers an array of backboards and rims with the Titan. Our Response™ tempered glass backboard offers the same look and authentic ball rebound enjoyed by college and professional players.

For added safety, pole padding and backboard padding are available for most Titan packages.

Every Titan package comes with a Lifetime Superior Warranty.

TITAN PACKAGE OPTIONS



- FT1600 Titan Pole System
- FT222 42"x72" Acrylic Backboard
- FT186 Heavy Duty Flex Goal
- Lifetime Superior Warranty
- Approx. Shipping Weight: 380 lbs.

- FT1600 Titan Pole System
- FT232 42"x72" Tempered Glass Bkdb.
- FT186 Heavy Duty Flex Goal
- Lifetime Superior Warranty
- Approx. Shipping Weight: 450 lbs.

- FT1600 Titan Pole System
- FT260 42"x60" Steel Backboard
- FT172D Unbreakable Fixed Goal
- Lifetime Superior Warranty
- Approx. Shipping Weight: 400 lbs.

- FT1600 Titan Pole System
- FT265 42"x72" Steel Backboard
- FT172D Unbreakable Fixed Goal
- Lifetime Superior Warranty
- Approx. Shipping Weight: 440 lbs.

- FT1600 Titan Pole System
- FT261 42"x60" Aluminum Bkdb.
- FT172D Unbreakable Fixed Goal
- Lifetime Superior Warranty
- Approx. Shipping Weight: 320 lbs.

the OLYMPIAN

ADJUSTABLE BASKETBALL SYSTEM



- Backboards are available in 42"x72" acrylic or tempered glass.
- Optional bolt-on TuffGuard™ backboard padding available in several colors

• All First Team goals are "direct mounted" to eliminate backboard breakage when players hang on the rim.

• Massive 6"x8" (1/4" wall) post gives incredible stability to unit

FREE!

LTR 80P Post Pad Lettering Upon Request With Purchase of Complete System

• Optional all-weather velcro wrap-around post padding for added safety (See padding section for available colors)

• EZ Crank™ adjustment allows infinite height adjust. from 10' - 6'6"

• Unique anchor system allows perfect pole leveling and easy pole removal if you move.

• Post to backboard extension distance is 48" with rim at 10' (Extension distance increases as rim height is lowered)

The Olympian offers infinite height adjustment with unmatched durability and stability! First Team has designed the Olympian to outperform ANY basketball system on the planet! The Olympian's toughness and rigidity will amaze you and make your court the envy of the neighborhood!

The Olympian's oversized 6" x 8" x 1/4" thick wall is a monster! Combine this with our LCG (Low Center of Gravity) pole structure design and welded dual strut extension arm and it makes for the most rigid pole structure available, hands down! The post is set back 4' from the backboard to maximize safety as well. The bolt down anchor footing allows you to easily relocate the unit if you move.

Our EZ-Crank™ adjustment and trademarked "Double Spring-Assist" make rim height adjustments a snap! To adjust, simply turn the crank handle. Any age player will be able to quickly and easily change rim heights anywhere from 10' down to 6'6". A clear and accurate rim height indicator is included.

First Team offers you a choice of clear acrylic or tempered glass backboards on the Olympian. Our Response™ tempered glass backboard offers the same look and authentic ball rebound enjoyed by college and professional players.

For additional safety, pole padding and backboard padding are available for any Olympian basketball system.

Every Olympian package comes with a Lifetime Superior Warranty.

OLYMPIAN PACKAGE OPTIONS

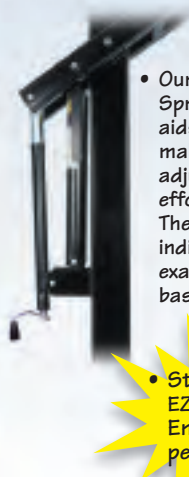

• Our trademarked Spring Assist™ aids the crank, making goal adjustments effortless. The rim height indicator shows exact height of basket.

• Stainless steel EZ Crank™! Ensures lifelong performance!

See Accessories Section for Backboard & Pole Padding Options.



OLYMPIAN SUPREME



OLYMPIAN ARENA

- FT1625 Olympian Pole System
- FT222 42"x72" Acrylic Backboard
- FT186 Heavy Duty Flex Goal
- Lifetime Superior Warranty
- Approx. Shipping Weight: 480 lbs.

- FT1625 Olympian Pole System
- FT232 42"x72" Tempered Glass Backboard
- FT186 Heavy Duty Flex Goal
- Lifetime Superior Warranty
- Approx. Shipping Weight: 550 lbs.

www.firstteaminc.com

First Team, Inc. • Hutchinson, Kansas • Toll-Free 1-800-649-3688

the POWERHOUSE CHALLENGER

ADJUSTABLE BASKETBALL SYSTEM



- Backboards available in acrylic or glass
- Breakaway goal included
- Optional bolt-on TuffGuard™ backboard padding available in several colors
- Optional all-weather velcro wrap-around post padding for added safety (See padding section for available colors)
- EZ Crank™ adjustment allows infinite height adjustment from 10' to 7½'
- Bolt-down anchor base

• Baseplate to backboard extension is 30" with rim at 10' (Extension distance increases as rim height is lowered)

First Team proudly announces our latest addition to the PowerHouse line of hoops...Challenger! The PowerHouse Challenger pole system boasts all the features you need for great performance at a price everyone can enjoy!

The PowerHouse Challenger series is designed with performance and economy in mind. The unit is built with a 5"x5" vertical post that incorporates our bolt-down anchor base for ease of assembly and relocation. The rim height is infinitely adjustable by simply turning the EZ Crank handle. The rim height indicator registers the 10' rim height. Our Y-shaped extension arms provide a solid 30" offset from post to backboard. Choose from tempered glass or acrylic backboards available in 54" and 60" widths.

For additional safety, pole padding and backboard padding can be added to any Challenger package. PowerHouse Challenger packages are covered by First Team's Limited Lifetime Warranty.

When you're looking for great performing basketball system for your home court, look no further than Challenger!

CHALLENGER PACKAGE OPTIONS



- | | | | |
|---|---|--|--|
| <ul style="list-style-type: none"> • PH05CH Challenger Pole System • FT215 36"x54" Acrylic Backboard • FT186 Heavy Duty Flex Goal • Limited Lifetime Warranty • Approx. Shipping Weight: 200 lbs. | <ul style="list-style-type: none"> • PH05CH Challenger Pole System • FT220 36"x60" Acrylic Backboard • FT186 Heavy Duty Flex Goal • Limited Lifetime Warranty • Approx. Shipping Weight: 210 lbs. | <ul style="list-style-type: none"> • PH05CH Challenger Pole System • FT216 36"x54" Tempered Glass Bkbd. • FT186 Heavy Duty Flex Goal • Limited Lifetime Warranty • Approx. Shipping Weight: 200 lbs. | <ul style="list-style-type: none"> • PH05CH Challenger Pole System • FT221 36"x60" Tempered Glass Bkbd. • FT186 Heavy Duty Flex Goal • Limited Lifetime Warranty • Approx. Shipping Weight: 210 lbs. |
|---|---|--|--|

the POWERHOUSE 5

ADJUSTABLE BASKETBALL SYSTEM



- Unique CLEARSPAN™ backboard mount eliminates any visual obstructions behind glass

- Breakaway goal included

- Optional bolt-on TuffGuard™ backboard padding available in several colors

- Super Tough 5"x5" post gives stability to unit

- EZ Crank™ adjustment allows infinite height adjustment from 10' to 7'

- 16" clearance from back of post to crank handle

- Optional all-weather velcro wrap-around post padding for added safety (See padding section for available colors)

- Unique anchor system allows perfect pole leveling and easy pole removal if you move

- Baseplate to backboard extension is 36" with rim at 10' (Extension distance increases as rim height is lowered)

First Team is proud to introduce the POWERHOUSE 5 basketball system! The PowerHouse 5 offers all of the great features you need at a price that will put you in the game!

The PowerHouse series of basketball systems was designed with performance, aesthetic appeal and economy in mind. The unit is built with a one-piece 5"x5" vertical post that incorporates our bolt-down anchor base for ease of assembly and relocation. The rim height is infinitely adjustable by simply turning the EZ Crank handle. The rim height indicator shows the height of the rim. Our Y-shaped extension arms and steel perimeter framed tempered glass backboard combine with First Team's exclusive CLEARSPAN™ backboard mounting making PowerHouse the most powerful and aesthetic units available in their price range!

For additional safety, pole padding and backboard padding can be added to any PowerHouse package.

When you're looking for a crank adjustable basketball system that looks as great as it performs, the CLEAR choice is POWERHOUSE!

PowerHouse 5 systems carry a Limited Lifetime Warranty.

POWERHOUSE 5 PACKAGE OPTION

See Accessories Section for Backboard & Pole Padding Options.

POWERHOUSE 560

- 5" Square Powerhouse Post
- 36" Offset Extension Arms
- PH4260 42"x60" Tempered Glass Backboard
- FT186 Heavy Duty Flex Goal
- Limited Lifetime Warranty
- Approx. Shipping Weight: 380 lbs.

www.firstteaminc.com

First Team, Inc. • Hutchinson, Kansas • Toll-Free 1-800-649-3688

the POWERHOUSE 6

ADJUSTABLE BASKETBALL SYSTEM



- Unique CLEARSPAN™ backboard mount eliminates any visual obstructions behind glass
- Breakaway goal included
- Optional bolt-on TuffGuard™ backboard padding available in several colors
- Super Tough 6"x6" post gives stability to unit

FREE!

LTR 78
Post Pad Lettering
Upon Request
With Purchase of
Complete System

- Baseplate to backboard extension varies from 36" to 48" depending on package (see below for details).

First Team is proud to introduce the POWERHOUSE 6 basketball systems! The PowerHouse 6 line offers all of the great features you need at a price that will put you in the game!

The PowerHouse series of basketball systems was designed with performance, aesthetic appeal and economy in mind. The unit is built with a one-piece 6"x6" vertical post that incorporates our bolt-down anchor base for ease of assembly and relocation. The rim height is infinitely adjustable by simply turning the EZ Crank handle. The rim height indicator shows the height of the rim. Our Y-shaped extension arms and steel perimeter framed tempered glass backboard combine with First Team's exclusive CLEARSPAN™ backboard mounting making PowerHouse the most powerful and aesthetic units available in their price range!

For additional safety, pole padding and backboard padding can be added to any PowerHouse package.

When you're looking for a crank adjustable basketball system that looks as great as it performs, the CLEAR choice is POWERHOUSE!

Each PowerHouse 6 basketball system is covered by a Limited Lifetime Warranty.

POWERHOUSE 6 PACKAGE OPTIONS

- EZ Crank™ adjustment allows infinite height adjustment from 10' to 7'
- 16" clearance from back of post to crank handle
- Optional all-weather velcro wrap-around post padding for added safety (See padding section for available colors)
- Unique anchor system allows perfect pole leveling and easy pole removal if you move.



POWERHOUSE 660

- 6" Square Powerhouse Post
- 36" Offset Extension Arms
- PH4260 42"x60" Tempered Glass Backboard
- FT186 Heavy Duty Flex Goal
- Limited Lifetime Warranty
- Approx. Shipping Weight: 390 lbs.



POWERHOUSE 672

- 6" Square Powerhouse Post
- 48" Offset Extension Arms
- PH4272 42"x72" Tempered Glass Backboard
- FT186 Heavy Duty Flex Goal
- Limited Lifetime Warranty
- Approx. Shipping Weight: 415 lbs.

See
Accessories
Section for
Backboard &
Pole Padding
Options.

the HYDROCHAMP

ADJUSTABLE BASKETBALL SYSTEM



- Selection of various clear acrylic backboards in sizes ranging from 36"x48" to 36"x60"

- Welded top cap seals out moisture

- All components are powder coated black.

- Insta-Just™ height adjustment. No need for tools or a ladder. A simple broom handle allows you to adjust rim height in 6" increments.

- Stainless Steel post & anchor bolts

- Extension arms constructed of standard carbon steel, powdercoated black

- Special zinc undercoating protects against rust

- Optional bolt-on TuffGuard™ backboard padding available in several colors

- All First Team goals are "direct mounted" to eliminate backboard breakage when players hang on the rim.

- Post to backboard extension distance is 18" with rim at highest point (Extension distance increases as rim height is lowered)

First Team's making a splash with the HydroChamp! The HydroChamp makes a great unit for adjustable poolside basketball. The bolt down 4"x4" stainless steel post and adjustable carbon steel adjustable arm system combine for a durable, economical and aesthetically pleasing poolside unit. All components are powdercoated black.

To adjust the backboard height, simply release the adjustment mechanism located behind the rim. Unit has a 30" rim adjustment range, adjustable in 6" increments.

Unit is secured to pool deck using anchor bolts supplied with unit. Anchor base cover is also included. Choose from three backboard sizes 48", 54" or 60". The HydroChamp is the perfect unit for anyone looking for a high quality, professional looking poolside basketball unit. Give your pool the home court advantage with First Team's HydroChamp! Each HydroChamp package is covered by our Lifetime Limited Warranty!



- Protective cover hides anchor bolts

HYDROCHAMP PACKAGE OPTIONS



HYDROCHAMP II

- FT1103 Hydro Post
- FT1200 Champ Arm System
- FT210 36"x48" Acrylic Backboard
- FT186ZC Heavy Duty Flex Goal
- Lifetime Limited Warranty 🏠
- Approx. Shipping Weight: 157 lbs.



HYDROCHAMP III

- FT1103 Hydro Post
- FT1200 Champ Arm System
- FT215 36"x54" Acrylic Backboard
- FT186ZC Heavy Duty Flex Goal
- Lifetime Limited Warranty 🏠
- Approx. Shipping Weight: 167 lbs.



HYDROCHAMP SELECT

- FT1103 Hydro Post
- FT1200 Champ Arm System
- FT220 36"x60" Acrylic Backboard
- FT186ZC Heavy Duty Flex Goal
- Lifetime Limited Warranty 🏠
- Approx. Shipping Weight: 177 lbs.

www.firstteaminc.com

First Team, Inc. • Hutchinson, Kansas • Toll-Free 1-800-649-3688

the HYDROSHOT

ADJUSTABLE BASKETBALL SYSTEM



- All components are powder coated black.

- Selection of various clear acrylic backboards in sizes ranging from 36"x48" to 36"x60"

- Massive 4"x4" (3/16" wall) stainless steel post gives incredible stability to unit

- EZ Crank™ adjustment allows infinite height adjustment from 10' - 6'6"

- Special zinc undercoating protects against rust

- Tubular "H-Frame" design provides best backboard mounting available.

100%
stainless steel pole system construction!
Ensures lifelong performance!

- Optional bolt-on TuffGuard™ backboard padding available in several colors

- Protective cover hides anchor bolts

- All First Team goals are "direct mounted" to eliminate backboard breakage when players hang on the rim.

- Rim height lowers to 25" above mounting surface.

- Post to backboard extension distance is 36" with rim at 10' (Extension distance increases as rim height is lowered)

The HydroShot brings premium grade basketball performance to your poolside!

For those who love to hoop it up while they splash around, First Team introduces the HydroShot STAINLESS STEEL adjustable poolside basketball system. The HydroShot's 4" square post and dual strut extension arm make a "tough as nails" poolside unit that will NEVER RUST!! No more flimsy, plastic models. The HydroShot will far exceed your expectations for a poolside basketball unit.

The HydroShot comes complete with your choice of three clear, professional looking acrylic

backboards and breakaway rim. To adjust the unit, simply turn the crank handle positioned for easy access from the pool deck. The unit is infinitely adjustable from regulation 10' down to 6'6". An easy-to-read height indicator is provided as well.

Designed for commercial waterparks, the HydroShot also makes a first class residential poolside hoop. First Team's unique anchor bolt installation design allows you to easily relocate the unit if you ever need to. An anchor bolt cover is provided with each unit. For additional safety, backboard padding is available for all HydroShot models.

HYDROSHOT PACKAGE OPTIONS



HYDROSHOT II

- FT1350 HydroShot Mount System
- FT210 36"x48" Acrylic Backboard
- FT186ZC Heavy Duty Flex Goal
- Lifetime Limited Warranty
- Approx. Shipping Weight: 245 lbs.



HYDROSHOT III

- FT1350 HydroShot Mount System
- FT215 36"x54" Acrylic Backboard
- FT186ZC Heavy Duty Flex Goal
- Lifetime Superior Warranty
- Approx. Shipping Weight: 255 lbs.



HYDROSHOT SELECT

- FT1350 HydroShot Mount System
- FT220 36"x60" Acrylic Backboard
- FT186ZC Heavy Duty Flex Goal
- Lifetime Superior Warranty
- Approx. Shipping Weight: 265 lbs.

the HYDROSPORT

FIXED HEIGHT BASKETBALL SYSTEM



• Selection of various clear acrylic backboards in sizes ranging from 36"x48" to 36"x60"

• Welded top cap seals out moisture

• All components are powder coated black.

• 4"x4" post gives incredible stability to unit

• Stainless Steel post & anchor bolts

• Extension arms constructed of carbon steel, powdercoated black

• Special zinc undercoating protects against rust

• Optional bolt-on TuffGuard™ backboard padding available in several colors

• All First Team goals are "direct mounted" to eliminate backboard breakage when players hang on the rim.

• Post to backboard extension distance is 24"

The HydroSport offers a professional look for you poolside at an affordable price! The HydroSport's black powdercoated 4"x4" stainless steel post is designed with a bolt down anchor system similar to our upper end driveway basketball systems. The unit is secured to the pool deck using four stainless steel anchor bolts provided with unit. An ABS plastic anchor cover is also included. The HydroSport's carbon steel extension arm is also powdercoated black and attaches to the post via U-bolts.



• Protective cover hides anchor bolts

Though the HydroSport is considered a "Fixed Height" goal, the U-bolts can be loosened allowing the arm to be re-attached at any given height along the post.

A variety of backboards are available on the HydroSport. Pick the package that is right for your pool. For additional safety backboard padding is available for all HydroSport packages.

Each HydroSport basketball system is covered by First Team's Lifetime Limited Warranty.

HYDROSPORT PACKAGE OPTIONS

HYDROSPORT II

- FT1103 Hydro Post
- FT1150 Sport Extension Arm
- FT210 36"x48" Acrylic Backboard
- FT186ZC Heavy Duty Flex Goal
- Lifetime Limited Warranty
- Approx. Shipping Weight: 142 lbs.

HYDROSPORT III

- FT1103 Hydro Post
- FT1150 Sport Extension Arm
- FT215 36"x54" Acrylic Backboard
- FT186ZC Heavy Duty Flex Goal
- Lifetime Limited Warranty
- Approx. Shipping Weight: 152 lbs.

HYDROSPORT SELECT

- FT1103 Hydro Post
- FT1150 Sport Extension Arm
- FT220 36"x60" Acrylic Backboard
- FT186ZC Heavy Duty Flex Goal
- Lifetime Limited Warranty
- Approx. Shipping Weight: 162 lbs.

www.firstteaminc.com

First Team, Inc. • Hutchinson, Kansas • Toll-Free 1-800-649-3688

the SPORT

FIXED HEIGHT BASKETBALL SYSTEM



- Selection of various clear acrylic backboards. Sizes range from 36"x48" to 36"x60"

- Super strength flex goals are "direct mounted" to eliminate any chance of backboard breakage

- Optional bolt-on TuffGuard™ backboard padding available in several colors

- Our one piece 4"x4" 11 ga. (1/8" wall) post is the heaviest of its kind in the industry

- Optional all-weather velcro wrap-around post padding for added safety (See padding section for available colors)

- Post is buried 36" below playing surface. (FT16 ground sleeve option can be purchased to make post removable.)



• Post to backboard extension distance is 24"

The Sport offers a professional look at an affordable price!

The Sport's 4"x4" 11 ga. steel post is 50% heavier than any goal of its kind. Our one piece post design eliminates the potential for joint deterioration common with sectional type posts.

The extension arm on the Sport is attached to the vertical post using two heavy duty U-bolts. Though the Sport is considered a "Fixed Height" goal, the U-bolts can be loosened allowing the arm to be re-attached at any given height along the post.

A variety of backboards and rims are offered with the Sport so you can choose the Sport package that's right for you.

For additional safety, pole padding and backboard padding can be added to any Sport package.

Every Sport package comes with a Lifetime Limited Warranty.

SPORT PACKAGE OPTIONS



SPORT II

- FT1100 4" Square Post
- FT1150 Sport Extension Arm
- FT210 36"x48" Acrylic Backboard
- FT184 Recreational Flex Goal
- Lifetime Limited Warranty 🏠
- Approx. Shipping Weight: 145 lbs.



SPORT III

- FT1100 4" Square Post
- FT1150 Sport Extension Arm
- FT215 36"x54" Acrylic Backboard
- FT186 Heavy Duty Flex Goal
- Lifetime Limited Warranty 🏠
- Approx. Shipping Weight: 155 lbs.



SPORT SELECT

- FT1100 4" Square Post
- FT1150 Sport Extension Arm
- FT220 36"x60" Acrylic Backboard
- FT186 Heavy Duty Flex Goal
- Lifetime Limited Warranty 🏠
- Approx. Shipping Weight: 165 lbs.

the LEGACY

FIXED HEIGHT BASKETBALL SYSTEM



- Selection of various clear acrylic and tempered glass backboards. Sizes range from 36"x48" to 36"x60"

- H-Frame backboard brace for simple installation and excellent backboard rigidity

- Super strength flex goals are "direct mounted" to eliminate any chance of backboard breakage

- Optional bolt-on TuffGuard™ backboard padding available in several colors

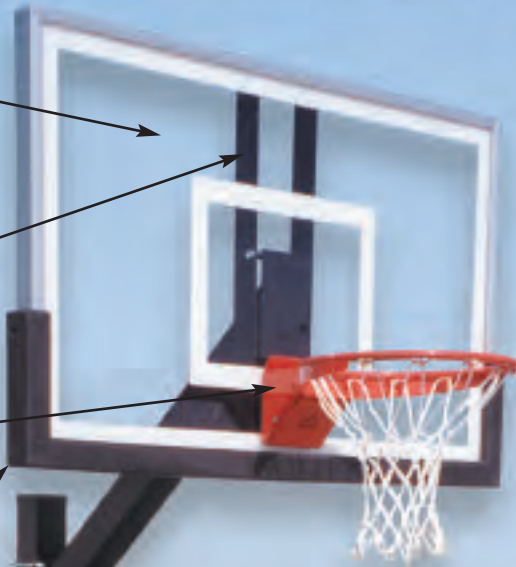

The Legacy offers added durability and safety without exceeding your budget!

The Legacy's 4"x4" 11 ga. steel post is 50% heavier than any goal of its kind. Our one piece pole design eliminates joint deterioration common with sectional type posts.

The extension arm on the Legacy is constructed of tough 4"x4" square tubing and provides players with a 36" extension distance from post to backboard for added safety. The Legacy arm is attached to the vertical post using U-bolts and is considered a "Fixed Height" goal. However, the U-bolts can be loosened allowing the arm to be re-attached at any given height along the post.

A selection of backboards and rims are offered with the Legacy so you can pick the one that's right for you.

For additional safety, pole padding and backboard padding can be added to any Legacy package.

Every Legacy package comes with a Lifetime Limited Warranty.

• Post to backboard extension distance is 36"

- Our one piece 4"x4" 11 ga. (1/8" wall) post is the heaviest of its kind in the industry

- Optional all-weather velcro wrap-around post padding for added safety (See padding section for available colors)

- Post is buried 36" below playing surface. (FT16 ground sleeve option can be purchased to make post removable.)

LEGACY PACKAGE OPTIONS



- FT1100 4" Square Post
- FT1700 Legacy Extension Arm
- FT215 36"x54" Acrylic Backboard
- FT186 Heavy Duty Flex Goal
- Lifetime Limited Warranty
- Approx. Shipping Weight: 205 lbs.

- FT1100 4" Square Post
- FT1700 Legacy Extension Arm
- FT220 36"x60" Acrylic Backboard
- FT186 Heavy Duty Flex Goal
- Lifetime Limited Warranty
- Approx. Shipping Weight: 215 lbs.

- FT1100 4" Square Post
- FT1700 Legacy Extension Arm
- FT216 36" x 54" Temp. Glass Bkbd.
- FT186 Heavy Duty Flex Goal
- Lifetime Limited Warranty
- Approx. Shipping Weight: 205 lbs.

- FT1100 4" Square Post
- FT1700 Legacy Extension Arm
- FT221 36" x 60" Temp. Glass Bkbd.
- FT186 Heavy Duty Flex Goal
- Lifetime Limited Warranty
- Approx. Shipping Weight: 215 lbs.

www.firstteaminc.com

First Team, Inc. • Hutchinson, Kansas • Toll-Free 1-800-649-3688

the

LEGEND JR.

FIXED HEIGHT BASKETBALL SYSTEM



- Extension arm is constructed of 5"x5" (3/16" wall) solid steel tubing
- All First Team goals are "direct mounted" to eliminate backboard breakage when players hang on the rim.
- Tough 5"x5" (3/16" wall) one piece steel post
- Optional all-weather velcro wrap-around post padding for added safety (See padding section for available colors)
- Post is buried 42" below playing surface. (FT17 ground sleeve option can be purchased to make post removable.)
- Extensive backboard selection is available
- Optional TuffGuard™ all-weather bolt-on backboard padding available in several colors
- Post to backboard extension distance is 52"

The Legend Jr. offers a combination of playground durability and professional performance!

The Legend Jr.'s vertical post and extension arm are both constructed of rugged 5" square 3/16" thick tubular steel. Combined they provide top-notch performance in both durability and rigidity. The post is set back 52" for added safety.

The extension arm on the Legend Jr. is attached to the vertical post using six high tensile 5/8" bolts. Though the Legend Jr. is considered a "Fixed Height" goal, the extension arm can be bolted at any height along the post.

First Team offers a large selection of backboards and rims with the Legend Jr. Choose a Legend Jr. package with one of our Response™ tempered glass backboards if you are wanting authentic gymnasium style ball reaction. Our popular Legend Jr. Dual packages add a second extension arm, backboard and rim to the opposite side of the post to maximize playing area on the playground.

For added safety, pole padding and backboard padding are available for most Legend Jr. packages.

Every Legend Jr. package comes with a Lifetime Superior Warranty.

LEGEND JR. PACKAGE OPTIONS

LEGEND JR.

III



LEGEND JR.

SELECT



LEGEND JR.
SELECT
DUAL

LEGEND JR.

ULTRA



- FT1105 5" Square Post
- FT1750 Legend Jr. Ext. Arm
- FT225 36"x54" Temp. Glass Bkbd.
- FT186 Heavy Duty Flex Goal
- Lifetime Superior Warranty 🏠
- Approx. Shipping Weight: 395 lbs.

LEGEND JR.

PRO



- FT1105 5" Square Post
- FT1750 Legend Jr. Ext. Arm
- FT230 36"x60" Temp. Glass Bkbd.
- FT186 Heavy Duty Flex Goal
- Lifetime Superior Warranty 🏠
- Approx. Shipping Weight: 405 lbs.

LEGEND JR.

EXTREME



LEGEND JR.
EXTREME
DUAL

- FT1105 5" Square Post
- FT1750 Legend Jr. Ext. Arm
- FT256 36"x60" Steel Bkbd.
- FT172D Unbreakable Fixed Goal
- Lifetime Superior Warranty
- Approx. Shipping Weight: 400 lbs.

- FT1105 5" Square Post
- FT1750 Legend Jr. Ext. Arm
- FT215 36"x54" Acrylic Bkbd.
- FT186 Heavy Duty Flex Goal
- Lifetime Superior Warranty
- Approx. Shipping Weight: 345 lbs.

- FT1105 5" Square Post
- FT1750 Legend Jr. Ext. Arm
- FT220 36"x60" Acrylic Bkbd.
- FT186 Heavy Duty Flex Goal
- Lifetime Superior Warranty
- Approx. Shipping Weight: 355 lbs.

www.firstteaminc.com

First Team, Inc. • Hutchinson, Kansas • Toll-Free 1-800-649-3688

the

LEGEND

FIXED HEIGHT BASKETBALL SYSTEM



- Extension arm is constructed of 6"x6" (3/16" wall) solid steel tubing
- All First Team goals are "direct mounted" to eliminate backboard breakage when players hang on the rim.
- Massive 6"x6" (3/16" wall) one piece steel post
- Optional all-weather velcro wrap-around post padding for added safety (See padding section for available colors)
- Post is buried 48" below playing surface. (FT18 ground sleeve option available to make post removable.)
- Extensive backboard selection is available
- Optional TuffGuard™ all-weather bolt-on backboard padding available in several colors
- Post to backboard extension distance is 66"

The Legend offers exceptional rigidity, uncompromising durability and maximum safety even on the toughest courts!

Built from heavy 6" square, 3/16" thick steel tubing, the Legend provides unmatched stability and durability. Designed for the most rugged playgrounds, the Legend performs equally well on the home court. The post is positioned 66" behind the backboard for safety.

The extension arm on the Legend is attached to the vertical post via six 5/8" high tensile bolts. Though the Legend is considered a "Fixed Height" goal, the extension arm can be bolted at any height along the post.

First Team offers an array of backboards and rims with the Legend. Our Response™ tempered glass backboard offers the same look and authentic ball rebound enjoyed by college and professional players. Our popular Legend Dual packages add a second extension arm, backboard and rim to the opposite side of the post to maximize playing area on the playground.

For additional safety, pole padding and backboard padding are available for most Legend packages.

Every Legend package comes with a Lifetime Warranty.

LEGEND PACKAGE OPTIONS

LEGEND SUPREME



LEGEND SUPREME DUAL

LEGEND ARENA



FREE!
LTR 78 Post Pad Lettering Upon Request With Purchase of Complete System

LEGEND PLAYGROUND



LEGEND PLAYGROUND DUAL

LEGEND EXCEL



LEGEND EXCEL DUAL

LEGEND DYNASTY



(Shown with optional FT11 chain net)

LEGEND DYNASTY DUAL

LEGEND IMPERVIA



- | | | | | | |
|-------------------------------------|-------------------------------------|-------------------------------------|-------------------------------------|-------------------------------------|-------------------------------------|
| • FT1106 6" Square Post | • FT1106 6" Square Post | • FT1106 6" Square Post | • FT1106 6" Square Post | • FT1106 6" Square Post | • FT1106 6" Square Post |
| • FT1850 Legend Extension Arm | • FT1850 Legend Extension Arm | • FT1850 Legend Extension Arm | • FT1850 Legend Extension Arm | • FT1850 Legend Extension Arm | • FT1850 Legend Extension Arm |
| • FT222 42"x72" Acrylic Bkdb. | • FT232 42"x72" Temp. Glass Bkdb. | • FT260 42"x60" Steel Backboard | • FT265 42"x72" Steel Backboard | • FT260 42"x72" Fiberglass Bkdb. | • FT261 42"x60" Aluminum Bkdb. |
| • FT186 Heavy Duty Flex Goal | • FT186 Heavy Duty Flex Goal | • FT172D Unbreakable Fixed Goal | • FT172D Unbreakable Fixed Goal | • FT172D Unbreakable Fixed Goal | • FT172D Unbreakable Fixed Goal |
| • Lifetime Superior Warranty | • Lifetime Superior Warranty | • Lifetime Unconditional Warranty | • Lifetime Unconditional Warranty | • Lifetime Unconditional Warranty | • Lifetime Unconditional Warranty |
| • Approx. Shipping Weight: 470 lbs. | • Approx. Shipping Weight: 540 lbs. | • Approx. Shipping Weight: 490 lbs. | • Approx. Shipping Weight: 530 lbs. | • Approx. Shipping Weight: 515 lbs. | • Approx. Shipping Weight: 370 lbs. |

www.firstteaminc.com

First Team, Inc. • Hutchinson, Kansas • Toll-Free 1-800-649-3688

the RENEGADE

FIXED HEIGHT BASKETBALL SYSTEM



- Extensive backboard selection. Backboards are available in steel, aluminum, fiberglass or clear acrylic. Sizes vary from 36"x48" to 42"x72".

- Backboard braces for superior backboard rigidity

- Vinyl post cap seals out moisture

- Extension arm and braces are powdercoated

- Extension arm clamps to vertical post using U-bolts. Extension arm can be moved by loosening U-bolts

- Post is weather resistant galvanized

- Heavy-Duty 4 1/2" O.D. schedule 40 steel post

- Post is buried 48" below playing surface.

The Renegade offers commercial durability and the added flexibility sometimes needed on the playground.

The Renegade post is constructed of 4 1/2" O.D. galvanized schedule 40 tubing. The post buries into the concrete a full 48" deep. A vinyl top cap seals out moisture.

The extension arm on the Renegade is attached to the vertical post using two heavy duty U-bolts. Though the Renegade is considered a "Fixed Height" goal, the U-bolts can be loosened, allowing the arm to be re-attached at any given height along the post.

An extensive selection of backboards and rims are available on the Renegade. Choose the package that fits your needs.

Every Renegade package comes with a 20-Year Limited Warranty.

- Super tuff flex or fixed goals are "direct mounted" to eliminate backboard stress.

RENEGADE PACKAGE OPTIONS



RENEGADE EXTREME

- FT1875 Renegade Post System
- FT1875EA Renegade Extension Arm
- FT256 36"x60" Steel Backboard
- FT172D Unbreakable Fixed Goal
- 20-Year Limited Warranty
- Approx. Shipping Weight: 295 lbs.

RENEGADE PLAYGROUND

- FT1875 Renegade Post System
- FT1875EA Renegade Extension Arm
- FT260 42"x60" Steel Backboard
- FT172D Unbreakable Fixed Goal
- 20-Year Limited Warranty
- Approx. Shipping Weight: 315 lbs.

RENEGADE MAX

- FT1875 Renegade Post System
- FT1875EA Renegade Extension Arm
- FT270 36"x54" Aluminum Backboard
- FT172D Unbreakable Fixed Goal
- 20-Year Limited Warranty
- Approx. Shipping Weight: 245 lbs.

RENEGADE IMPERVIA

- FT1875 Renegade Post System
- FT1875EA Renegade Extension Arm
- FT261 42"x 60" Aluminum Backboard
- FT172D Unbreakable Fixed Goal
- 20-Year Limited Warranty
- Approx. Shipping Weight: 260 lbs.

RENEGADE FLIGHT

- FT1875 Renegade Post System
- FT1875EA Renegade Extension Arm
- FT275 39"x54" Fiberglass Backboard
- FT172D Unbreakable Fixed Goal
- 20-Year Limited Warranty
- Approx. Shipping Weight: 245 lbs.

RENEGADE III

- FT1875 Renegade Post System
- FT1875EA Renegade Extension Arm
- FT215 36"x54" Acrylic Backboard
- FT186 Heavy Duty Flex Goal
- 20-Year Limited Warranty
- Approx. Shipping Weight: 240 lbs.

RENEGADE SELECT

- FT1875 Renegade Post System
- FT1875EA Renegade Extension Arm
- FT220 36"x60" Acrylic Backboard
- FT186 Heavy Duty Flex Goal
- 20-Year Limited Warranty
- Approx. Shipping Weight: 250 lbs.

RENEGADE SUPREME

- FT1875 Renegade Post System
- FT1875EA Renegade Extension Arm
- FT222 42"x72" Acrylic Backboard
- FT186 Heavy Duty Flex Goal
- 20-Year Limited Warranty
- Approx. Shipping Weight: 295 lbs.

the RUFFNECK

FIXED HEIGHT BASKETBALL SYSTEM



- Extensive backboard selection
- Heavy-Duty 4 1/2" O.D. schedule 40 post
- Post is weather resistant galvanized
- "Nose-cone" backboard mounting design with through-bolt permanently locking "Nose-cone" to post
- Post is buried 48" below playing surface.

The RuffNeck offers exceptional durability at a price that meets any budget.

The RuffNeck is a "Fixed Height" pole system constructed of 4 1/2" O.D. galvanized schedule 40 tubing. The direct rim mount design allows the rim to be mounted through the backboard and into the post, eliminating backboard stress. The backboard is further supported by two tubular braces fixed to the neck of the post.

Our unique "nose-cone" backboard mounting design makes backboard installation simple.

First Team offers a wide variety of backboard & rim styles on the RuffNeck system, allowing you to select the perfect RuffNeck package for your application. Every RuffNeck package comes with a 20-Year Limited Warranty.

- First Team goals are "direct mounted" to eliminate backboard stress

• Post to backboard extension distance is 48"

RUFFNECK PACKAGE OPTIONS



**RUFFNECK
EXTREME**

- FT1900 RuffNeck Post System
- FT1900NC RuffNeck Nose-cone
- FT256 36"x60" Steel Backboard
- FT172D Unbreakable Fixed Goal
- 20-Year Limited Warranty
- Approx. Shipping Weight: 290 lbs.



**RUFFNECK
PLAYGROUND**

- FT1900 RuffNeck Post System
- FT1900NC RuffNeck Nose-cone
- FT260 42"x60" Steel Backboard
- FT172D Unbreakable Fixed Goal
- 20-Year Limited Warranty
- Approx. Shipping Weight: 310 lbs.



**RUFFNECK
EXCEL**

- FT1900 RuffNeck Post System
- FT1900NC RuffNeck Nose-cone
- FT265 42"x72" Steel Backboard
- FT172D Unbreakable Fixed Goal
- 20-Year Limited Warranty
- Approx. Shipping Weight: 350 lbs.



**RUFFNECK
MAX**

- FT1900 RuffNeck Post System
- FT1900NC RuffNeck Nose-cone
- FT270 36"x54" Aluminum Backboard
- FT172D Unbreakable Fixed Goal
- 20-Year Limited Warranty
- Approx. Shipping Weight: 240 lbs.



**RUFFNECK
IMPERVIA**

- FT1900 RuffNeck Post System
- FT1900NC RuffNeck Nose-cone
- FT261 42"x60" Aluminum Bkbd.
- FT172D Unbreakable Fixed Goal
- 20-Year Limited Warranty
- Approx. Shipping Weight: 250 lbs.



**RUFFNECK
FLIGHT**

- FT1900 RuffNeck Post System
- FT1900NC RuffNeck Nose-cone
- FT275 39"x54" Fiberglass Backboard
- FT172D Unbreakable Fixed Goal
- 20-Year Limited Warranty
- Approx. Shipping Weight: 240 lbs.



**RUFFNECK
DYNASTY**

- FT1900 RuffNeck Post System
- FT1900NC RuffNeck Nose-cone
- FT280 42"x72" Fiberglass Backboard
- FT172D Unbreakable Fixed Goal
- 20-Year Limited Warranty
- Approx. Shipping Weight: 335 lbs.



**RUFFNECK
III**

- FT1900 RuffNeck Post System
- FT1900NC RuffNeck Nose-cone
- FT215 36"x54" Acrylic Backboard
- FT186 Heavy Duty Flex Goal
- 20-Year Limited Warranty
- Approx. Shipping Weight: 235 lbs.



**RUFFNECK
SELECT**

- FT1900 RuffNeck Post System
- FT1900NC RuffNeck Nose-cone
- FT220 36"x60" Acrylic Backboard
- FT186 Heavy Duty Flex Goal
- 20-Year Limited Warranty
- Approx. Shipping Weight: 245 lbs.



**RUFFNECK
SUPREME**

- FT1900 RuffNeck Post System
- FT1900NC RuffNeck Nose-cone
- FT222 42"x72" Acrylic Backboard
- FT186 Heavy Duty Flex Goal
- 20-Year Limited Warranty
- Approx. Shipping Weight: 290 lbs.

www.firstteaminc.com

First Team, Inc. • Hutchinson, Kansas • Toll-Free 1-800-649-3688

the TYRANT

FIXED HEIGHT BASKETBALL SYSTEM



- Extensive backboard selection. Backboards are available in steel, aluminum, fiberglass or clear acrylic. Sizes vary from 36"x54" to 42"x72".

- Heavy-Duty 6 5/8" O.D. schedule 40 galvanized post

- "Nose-cone" backboard mounting design with through-bolt permanently locking "Nose-cone" to post

- Post is buried 48" below playing surface.

- First Team goals are "direct mounted" to eliminate backboard stress

When it comes to the playground, no other basketball system can stand up to the TYRANT!

First Team's Tyrant basketball system is our largest, most rigid basketball system yet! With it's incredible 6 5/8" diameter galvanized post and outstanding 72" overhang, the Tyrant stands alone as the country's leading playground basketball system.

First Team has incorporated its easy to install nosecone into the Tyrant pole structure design. This makes installing the backboard much easier, minimizing backboard lifting when installing the backboard. The Tyrant is INDESTRUCTIBLE and First Team backs it with our LIFETIME UNCONDITIONAL WARRANTY!

For added safety, pole padding and backboard padding are available for any Tyrant basketball package.

So why let your basketball court be run down by other systems that can't hold up? Let First Team show you the true meaning of reliability and toughness with the TYRANT!

• Post to backboard extension distance is 72"

TYRANT EXTREME

- FT1910 Tyrant Post System
- FT1910NC Tyrant Nose-cone
- FT256 36"x60" Steel Backboard
- FT172D Unbreakable Fixed Goal
- Lifetime Unconditional Warranty
- Approx. Shipping Weight: 440 lbs.

TYRANT PLAYGROUND

- FT1910 Tyrant Post System
- FT1910NC Tyrant Nose-cone
- FT260 42"x60" Steel Backboard
- FT172D Unbreakable Fixed Goal
- Lifetime Unconditional Warranty
- Approx. Shipping Weight: 460 lbs.

TYRANT EXCEL

- FT1910 Tyrant Post System
- FT1910NC Tyrant Nose-cone
- FT265 42"x72" Steel Backboard
- FT172D Unbreakable Fixed Goal
- Lifetime Unconditional Warranty
- Approx. Shipping Weight: 500 lbs.

TYRANT MAX

- FT1910 Tyrant Post System
- FT1910NC Tyrant Nose-cone
- FT270 36"x54" Aluminum Backboard
- FT172D Unbreakable Fixed Goal
- Lifetime Unconditional Warranty
- Approx. Shipping Weight: 390 lbs.

TYRANT IMPERVIA

- FT1910 Tyrant Post System
- FT1910NC Tyrant Nose-cone
- FT261 42"x60" Aluminum Bkdb.
- FT172D Unbreakable Fixed Goal
- Lifetime Unconditional Warranty
- Approx. Shipping Weight: 395 lbs.

TYRANT FLIGHT

- FT1910 Tyrant Post System
- FT1910NC Tyrant Nose-cone
- FT275 39"x54" Fiberglass Backboard
- FT172D Unbreakable Fixed Goal
- Lifetime Unconditional Warranty
- Approx. Shipping Weight: 390 lbs.

TYRANT DYNASTY

- FT1910 Tyrant Post System
- FT1910NC Tyrant Nose-cone
- FT280 42"x72" Fiberglass Backboard
- FT172D Unbreakable Fixed Goal
- Lifetime Unconditional Warranty
- Approx. Shipping Weight: 485 lbs.

TYRANT III

- FT1910 Tyrant Post System
- FT1910NC Tyrant Nose-cone
- FT36 Silver Support Structure
- FT215 36"x54" Acrylic Backboard
- FT186 Heavy Duty Flex Goal
- Lifetime Unconditional Warranty
- Approx. Shipping Weight: 385 lbs.

TYRANT SELECT

- FT1910 Tyrant Post System
- FT1910NC Tyrant Nose-cone
- FT36 Silver Support Structure
- FT220 36"x60" Acrylic Backboard
- FT186 Heavy Duty Flex Goal
- Lifetime Unconditional Warranty
- Approx. Shipping Weight: 395 lbs.

TYRANT SUPREME

- FT1910 Tyrant Post System
- FT1910NC Tyrant Nose-cone
- FT36 Silver Support Structure
- FT222 42"x72" Acrylic Backboard
- FT186 Heavy Duty Flex Goal
- Lifetime Unconditional Warranty
- Approx. Shipping Weight: 440 lbs.

FIXED GOALS

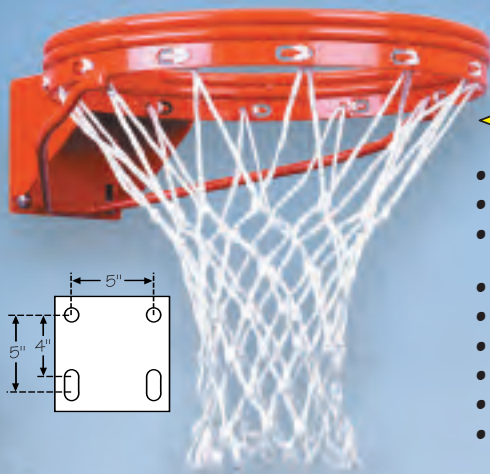

FT172D

- Most durable fixed goal in the industry
- Double 5/8" solid rim design
- "Never-Fail" 3/16"x1" Continuous net-lock eliminates net-lock breakage
- Accepts nylon or chain nets
- Durable powdercoat finish
- Recommended where other goals have failed
- Net and mounting hardware included
- Lifetime Unconditional Warranty
- Approx. Shipping Weight: 27 lbs.

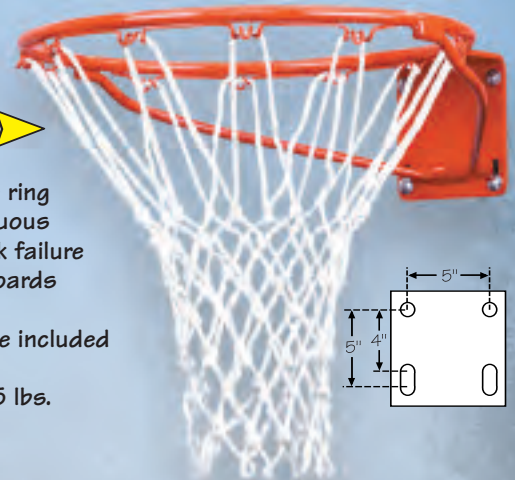
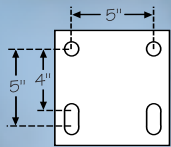

FT170

- Standard 5/8" high tensile ring
- Never-Fail 3/16" x 1" continuous net-lock eliminates net-lock failure
- Fits most standard backboards
- Durable powdercoat finish
- Net and mounting hardware included
- 1-Year Limited Warranty
- Approx. Shipping Weight: 15 lbs.

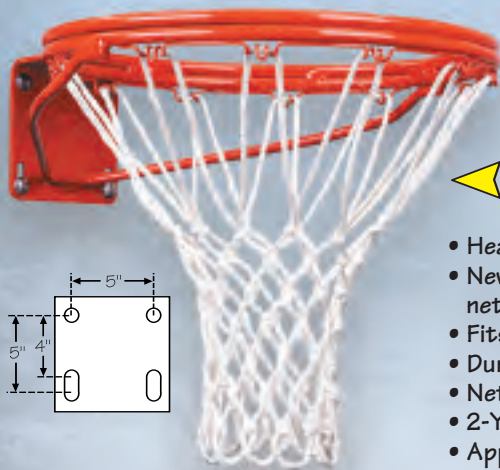
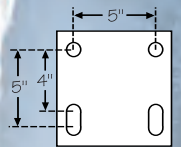

FT170D

- Heavy Duty 5/8" double ring design
- Never-Fail 3/16" x 1" continuous net-lock eliminates net-lock failure
- Fits most standard backboards
- Durable powdercoat finish
- Net and mounting hardware included
- 2-Year Superior Warranty
- Approx. Shipping Weight: 18 lbs.

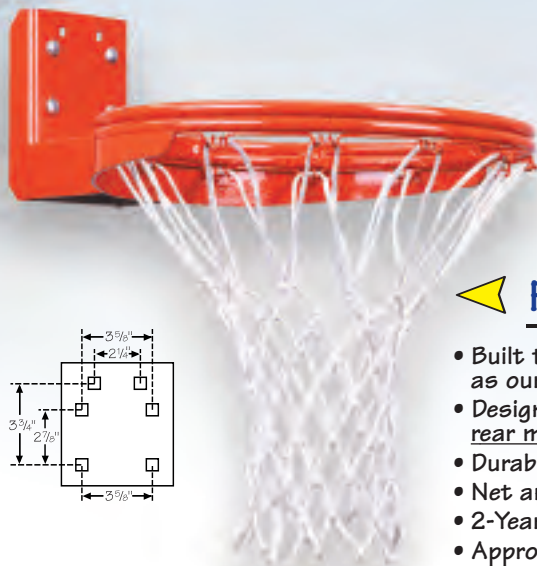
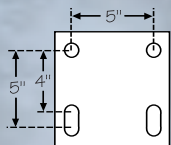

FT170R

- Built to the same specifications as our FT170 goal
- Designed to be used with rear mount backboards only
- Durable powdercoat finish
- Net and mounting hardware included
- 1-Year Limited Warranty
- Approx. Shipping Weight: 18 lbs.

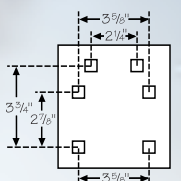

FT170DR

- Built to the same specifications as our FT170D goal
- Designed to be used with rear mount backboards only
- Durable powdercoat finish
- Net and mounting hardware included
- 2-Year Superior Warranty
- Approx. Shipping Weight: 23 lbs.

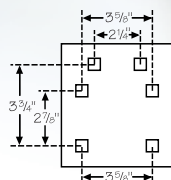

FLEX GOALS

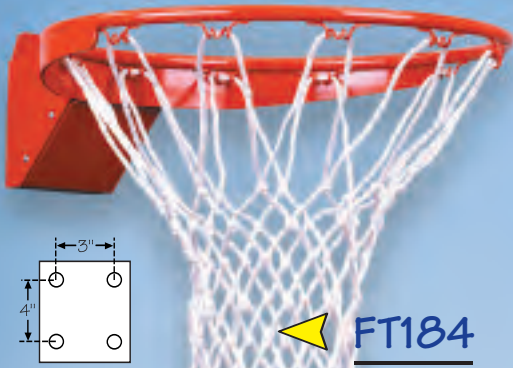

◀ **FT184**

- Recreational flex goal for home use
- Totally enclosed mechanism
- Durable powdercoat finish
- Net and mounting hardware included
- 1-Year Limited Warranty
- Approx. Shipping Weight: 19 lbs.

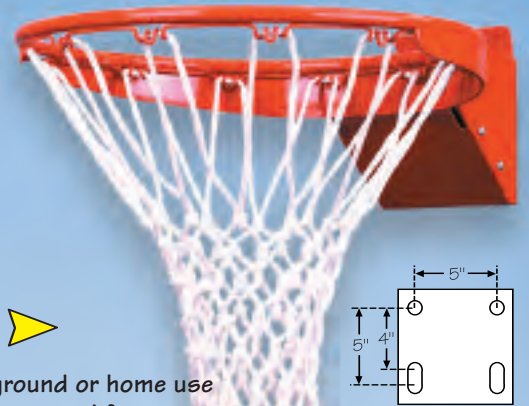

FT186 ▶

- Heavy duty flex goal for playground or home use
- Can also be used as a side court goal for gym use
- Low maintenance indoor/outdoor design
- 3/16" steel rim support with Continuous net-locks
- Totally enclosed mechanism
- Mounts to all standard backboards
- Durable powdercoat finish
- Net and mounting hardware included
- 2-Year Limited Warranty
- Approx. Shipping Weight: 21 lbs.



◀ **FT187D**

- Super duty double rim flex goal
- Great for highly aggressive playground use
- Double 5/8" solid steel rings
- Never-Fail 3/16" x 1" net locks
- Dual return springs
- Totally enclosed mechanism
- Mounts to most standard backboards
- Durable powdercoat finish
- Net and mounting hardware included
- 3-Year Superior Warranty
- Approx. Shipping Weight: 29 lbs.

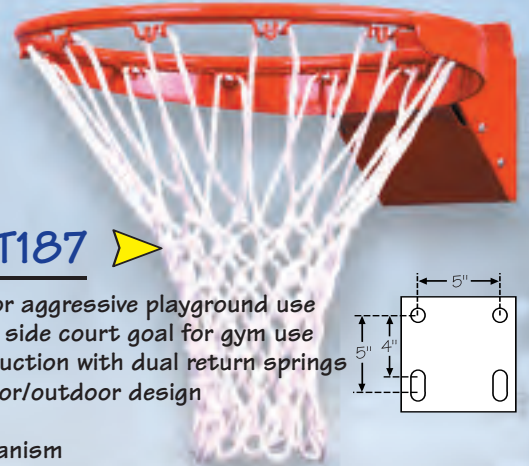

FT187 ▶

- Super duty flex goal for aggressive playground use
- Can also be used as a side court goal for gym use
- Extra strength construction with dual return springs
- Low maintenance indoor/outdoor design
- Continuous net-locks
- Totally enclosed mechanism
- Mounts to most standard backboards
- Durable powdercoat finish
- Net and mounting hardware included
- 2-Year Superior Warranty
- Approx. Shipping Weight: 24 lbs.



◀ **FT186ZC**

- Zinc undercoat for superior weather resistance
- Heavy duty flex goal for playground or home use
- Included on all First Team poolside units
- Great as an upgrade in difficult weather environments
- 3/16" steel rim support with Continuous net-locks
- Totally enclosed mechanism
- Mounts to all standard backboards
- Durable powdercoat finish
- Net and mounting hardware included
- 2-Year Limited Warranty
- Approx. Shipping Weight: 21 lbs.



FT187R ▶

- Built to the same specifications as our FT187 goal
- Designed to be used with rear mount backboards only
- Durable powdercoat finish
- Net and mounting hardware included
- 2-Year Superior Warranty
- Approx. Shipping Weight: 25 lbs.



STEEL & ALUMINUM BACKBOARDS

FT270

- 100% Aluminum Construction

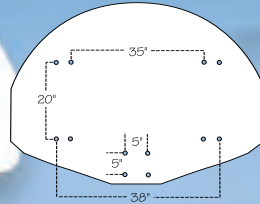

- 36"x54" Fan-shaped aluminum backboard
- Cast aluminum design
- White weather resistant powdercoat
- Official orange shooters square
- 10-Year Limited Warranty
- Approx. Shipping Weight: 52 lbs.

FT261

- 100% Aluminum Construction

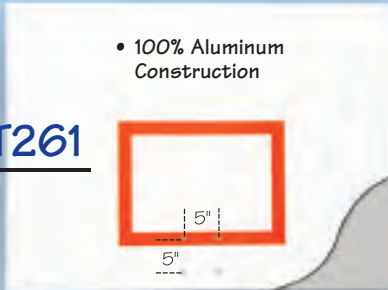

- 42"x60" Rectangular aluminum backboard
- 10 ga. construction
- White weather resistant powdercoat
- Official orange shooters square
- Warranted on First Team systems only
- Approx. Shipping Weight: 39 lbs.

FT256

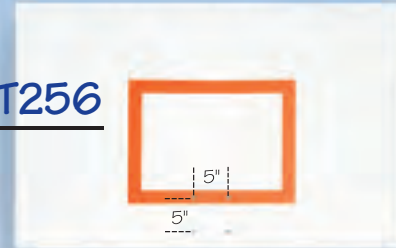

- 3'x5' Rectangular steel backboard
- 10 ga. construction
- White weather resistant powdercoat
- Official orange shooters square
- Warranted on First Team systems only
- Approx. Shipping Weight: 90 lbs.

FT260B

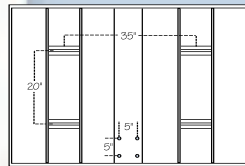

- 3 1/2'x5' Rectangular steel backboard
- 10 ga. skin & 1/4" steel support structure
- White weather resistant powdercoat
- Official orange shooters square
- 10-Year Superior Warranty
- Approx. Shipping Weight: 150 lbs.

FT260

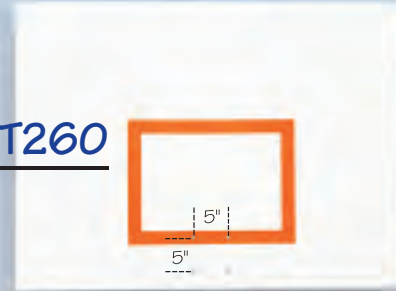

- 3 1/2'x5' Rectangular steel backboard
- 10 ga. construction
- White weather resistant powdercoat
- Official orange shooters square
- Warranted on First Team systems only
- Approx. Shipping Weight: 125 lbs.

FT265B

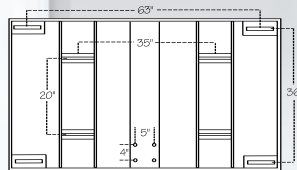

- 3 1/2'x6' Rectangular steel backboard
- 10 ga. skin & 1/4" steel support structure
- White weather resistant powdercoat
- Official orange shooters square
- 10-Year Superior Warranty
- Approx. Shipping Weight: 190 lbs.

FT265

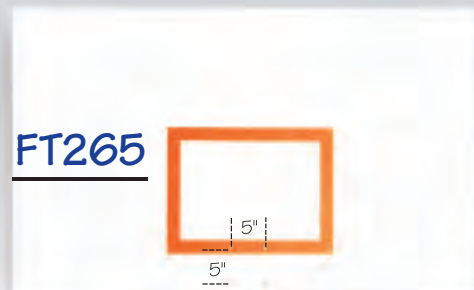

- 3 1/2'x6' Rectangular steel backboard
- 10 ga. construction
- White weather resistant powdercoat
- Official orange shooters square
- Warranted on First Team systems only
- Approx. Shipping Weight: 165 lbs.

www.firstteaminc.com

First Team, Inc. • Hutchinson, Kansas • Toll-Free 1-800-649-3688



FIBERGLASS BACKBOARDS



FT275

- Official fan-shaped 39"x54" fiberglass backboard
- Waterproof construction for indoor/outdoor use
- Orange markings are "molded-in"
- 10-Year Limited Warranty
- Approx. Shipping Weight: 107 lbs.

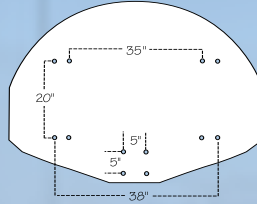

FT280

- Official 42"x72" rectangular fiberglass backboard
- Waterproof construction for indoor/outdoor use
- Orange markings are "molded-in"
- 10-Year Limited Warranty
- Approx. Shipping Weight: 143 lbs.

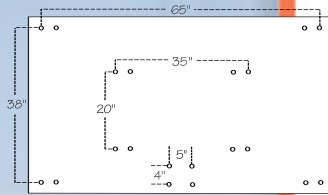

ACRYLIC BACKBOARDS



FT210

- 36"x48" acrylic backboard
- All weather 3/8" thick clear acrylic
- Heavy anodized aluminum framework
- Warranted on First Team systems only
- Approx. Shipping Weight: 36 lbs.

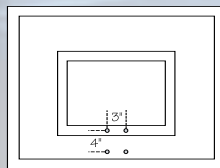

FT215

- 36"x54" all weather 1/2" thick clear acrylic
- Heavy anodized aluminum framework
- Warranted on First Team systems only
- Approx. Shipping Weight: 45 lbs.

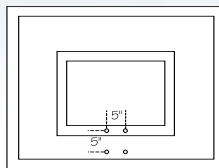



ACRYLIC BACKBOARDS



FT222 ▶

- 42"x72" acrylic backboard
- All weather 1/2" thick clear acrylic
- Competition grade anodized alum. frame
- Warranted on First Team systems only
- Approx. Shipping Weight: 100 lbs.

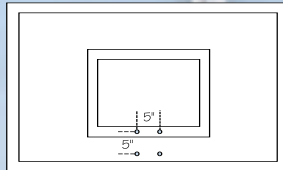
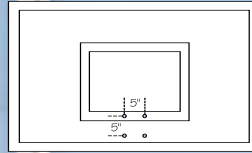

◀ FT220

- 36"x60" acrylic backboard
- All weather 1/2" thick clear acrylic
- Heavy anodized aluminum framework
- Warranted on First Team systems only
- Approx. Shipping Weight: 55 lbs.



◀ FT220H

- 36"x60" acrylic backboard
- All weather 1/2" thick clear acrylic
- Heavy anodized aluminum framework
- FT36HFM H-Frame provides rim support
- 10-Year Limited Warranty
- Approx. Shipping Weight: 100 lbs.

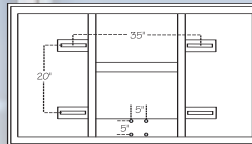

FT222H ▶

- 42"x72" acrylic backboard
- All weather 1/2" thick clear acrylic
- Competition grade anodized alum. frame
- FT42HFM H-Frame provides rim support
- 10-Year Limited Warranty
- Approx. Shipping Weight: 145 lbs.

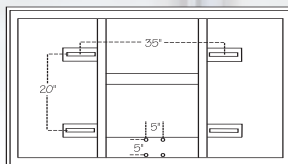

FT216

- 36"x54" cushioned 1/4" tempered glass
- Anodized aluminum framework
- Warranted on First Team systems only
- Approx. Shipping Weight: 45 lbs.

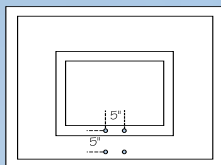

FT225

- 36"x54" Response™ tempered glass backboard
- All weather 3/8" thick tempered glass
- Competition grade aluminum framework
- Provides gymnasium quality ball reaction off board
- Warranted on First Team systems only
- Approx. Shipping Weight: 90 lbs.

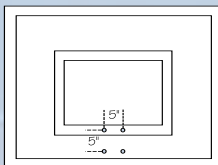

FT232

- 42"x72" Response™ tempered glass backboard
- All weather 1/2" thick tempered glass
- Competition grade aluminum framework
- Provides gymnasium quality ball reaction off of board
- Warranted on First Team systems only
- Approx. Shipping Weight: 170 lbs.

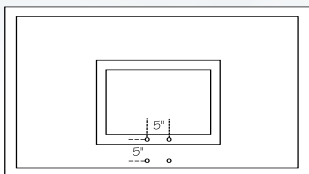

BACKBOARDS



FT221

- 36"x60" tempered glass backboard
- Cushioned 1/4" thick tempered glass
- Anodized aluminum framework
- Warranted on First Team systems only
- Approx. Shipping Weight: 55 lbs.

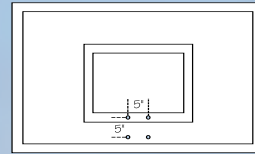

FT230

- 36"x60" Response™ tempered glass backboard
- All weather 3/8" thick tempered glass
- Competition grade aluminum framework
- Provides gymnasium quality ball reaction off board
- Warranted on First Team systems only
- Approx. Shipping Weight: 100 lbs.

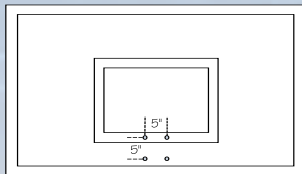

FT230H

- 36"x60" Response™ tempered glass backboard
- All weather 3/8" thick tempered glass
- Competition grade aluminum framework
- Provides gymnasium quality ball reaction off board
- FT36HFM H-Frame provides rim support
- 10-Year Limited Warranty
- Approx. Shipping Weight: 145 lbs.

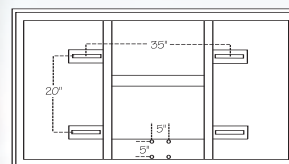

BACKBOARD PADDING



Backboard padding is available in these colors. Shades may vary slightly from color chart.

BK Black	RY Royal Blue
SC Scarlet	FG Forest Green
GR Grey	



FT48-XX

- XX designates color selection from chart
- TuffGuard™ 48" backboard padding
- Molded urethane construction
- Secures to backboard via self-drilling screws
- All-weather
- Fits most 48" wide backboards
- 1-Year Limited Warranty
- Approx. Shipping Weight: 6 lbs.



FT54-XX

- XX designates color selection from chart
- TuffGuard™ 54" backboard padding
- Molded urethane construction
- Secures to backboard via self-drilling screws
- All-weather
- Fits most 54" wide backboards
- 1-Year Limited Warranty
- Approx. Shipping Weight: 7 lbs.



FT60-XX

- XX designates color selection from chart
- TuffGuard™ 60" backboard padding
- Molded urethane construction
- Secures to backboard via self-drilling screws
- All-weather
- Fits most 60" wide backboards
- 1-Year Limited Warranty
- Approx. Shipping Weight: 8 lbs.



FT72-XX

- XX designates color selection from chart
- TuffGuard™ 72" backboard padding
- Molded urethane construction
- Secures to backboard via self-drilling screws
- All-weather
- Fits most 72" wide backboards
- 1-Year Limited Warranty
- Approx. Shipping Weight: 9 lbs.

SAFETY PADDING & CUSTOM LETTERING



FT75-XX

- Premium pole pad for 4" or 5" posts
- Foam pad (1 1/2" thick) with sewn vinyl cover
- All-weather
- Velcro wrap attachment
- Pole pad is 66" tall
- 1-Year Limited Warranty
- App. Ship. Wt: 8 lbs.

FT74-XX

- Pyramid shaped gusset pad
- Fits bolt-down goals with 4" or 5" posts
- Also covers FT16 & FT17 ground sleeve options
- 1-Year Limited Warranty
- App. Ship. Wt: 2 lbs.

FT76-XX Pole Pad Combo

- Includes FT75-XX Pole Pad & FT74-XX Gusset Pad
- 1-Year Limited Warranty
- Approx. Shipping Weight: 10 lbs.



FT78-XX

- Premium pole pad for 6" square posts
- Foam pad (2" thick) with sewn vinyl cover
- All-weather
- Contoured shape with velcro attachment
- Pole pad is 60" tall
- 1-Year Limited Warranty
- App. Ship. Wt: 8 lbs.

FT77-XX

- Pyramid shaped gusset pad
- Fits bolt-down goals with 6" posts
- Also covers FT18 ground sleeve option
- 1-Year Limited Warranty
- App. Ship. Wt: 2 lbs.

FT79-XX Pole Pad Combo

- Includes FT78-XX Pole Pad & FT77-XX Gusset Pad
- 1-Year Limited Warranty
- Approx. Shipping Weight: 10 lbs.



FT80P-XX

- Same features as FT78-XX except:
- Deluxe pole pad for 6"x8" EZ-Crank pole systems
- 1-Year Limited Warranty
- App. Ship. Wt: 10 lbs.

FT80G-XX

- Deluxe gusset pad for 6"x8" EZ-Crank pole systems
- 1-Year Limited Warranty
- App. Ship. Wt: 2 lbs.

FT80-XX Pole Pad Combo

- Includes FT80P-XX Pole Pad & FT80G-XX Gusset Pad
- 1-Year Limited Warranty
- Approx. Shipping Weight: 10 lbs.

Pole Pads Now Available in 16 Colors

FREE POST PAD LETTERING UPON REQUEST WITH PURCHASE OF COMPLETE SYSTEM

FREE POST PAD LETTERING UPON REQUEST WITH PURCHASE OF COMPLETE SYSTEM

How to Order Custom Lettering for Padding:

First Team offers free custom lettering on most, but not all padding with the purchase of a complete system. Check catalog for lettering availability or call First Team for details.

Choose from 3 font styles, shown at right. Each font is available with or without a background color. Choose lettering color (foreground) from the colors shown below. If applicable, choose background color. Add the necessary elements to the padding model number to be lettered as shown in the examples:

Font Style ▼

Word(s) to Print (Max. 10 Letters) ▼

LTR 78 : 1 RY H U T C H

▲ Foreground Lettering Color

▲ In this example, customer wants to letter on FT78 pole pad, using font style #1 with royal blue letters. Customer does not want a background color.

▼ Background Lettering Color

LTR 78 : 2 RY - W H H U T C H

▲ In this example, customer wants font style #2 with royal blue foreground letters and white background outline.

Maximum 10 letters per pad.

First Team art department will space letters accordingly.

LTR □□□□ : □□□ - □□

Word(s) to Print (Max. 10 Letters)

FT81BC

- Protective padding for RollAbout ballast boxes (set of 2)



- Makes box corners much safer
- 2" thick foam vinyl covered pad
- All-weather pad slips on and off
- 1-Year Limited Warranty
- Approx. Shipping Weight: 10 lbs.

FT82BC

- Protective padding for Rampage ballast box



Font Style #1

Font Style #2

Font Style #3



ABCDEFGHIJ
KLMNOPQR
STUVWXYZ

ABCDEFGHIJ
KLMNOPQR
STUVWXYZ

ABCDEFGHIJ
KLMNOPQR
STUVWXYZ

To order lettering, photocopy this form and fax with padding order to: 620.663.6055.

Safety Padding and Custom Pad Lettering is available in these colors. Use color codes for ordering. Shades may vary slightly from color chart.

RY Royal Blue	SC Scarlet	GL Gold	PR Purple	KG Kelly Green	BK Black	CB Columbia Blue	MR Maroon	GR Grey	NB Navy Blue	OR Orange	FG Forest Green	BR Brick Red	SO Sienna Orange	DG Desert Gold	SB Saddle Brown	WH White (Lettering Only)
------------------	---------------	------------	--------------	-------------------	-------------	---------------------	--------------	------------	-----------------	--------------	--------------------	-----------------	---------------------	-------------------	--------------------	------------------------------

www.firstteaminc.com

First Team, Inc. • Hutchinson, Kansas • Toll-Free 1-800-649-3688



▲ FT20

- Basketball Court Stencil Kit
- Provides an easy way to paint a regulation lane, free throw line and circle on any cement or blacktop surface
- Includes 3-point line
- Approx. Shipping Weight: 5 lbs.



FT16 ▲

- Ground sleeve for 4" direct bury posts
- Makes post removal easy
- Sleeves cements in place and post fits inside
- Post secures inside sleeve via eight tension bolts
- Sleeve buries 36" below playing surface
- Allows perfect post leveling
- 5-Year Superior Warranty
- Approx. Shipping Weight: 42 lbs.



FT17 (Not shown)

- Same features as FT16 except:
- Ground sleeve for 5" direct bury posts
- Sleeve buries 42" below playing surface
- 10-Year Superior Warranty
- Approx. Shipping Weight: 57 lbs.

▲ FT36-HFM

- Recommended for use when certain First Team backboards are purchased separately (see list below)
- H-Frame provides mounting attachments and adequate rim support
- Provides 10-Year Limited Warranty on H-Frame and backboard
- FT36-HFM fits: FT210, FT215, FT220, FT225 & FT230
- FT42-HFM fits: FT222

▲ FT42-HFM

FT18 (Not shown)

- Same features as FT16 except:
- Ground sleeve for 6" direct bury posts
- Sleeve buries 48" below playing surface
- 10-Year Superior Warranty
- Approx. Shipping Weight: 72 lbs.

ACCESSORIES



FT52 ▲

- Top Ring & Lid for floating floors
- Allows floating floors to move without damaging floor
- 5" I.D. Ring secures to floor
- Lid sits flush to finished floor
- Approx. Shipping Weight: 5 lbs.

FT22 ▶

- Defender Ball Retention Net
- Maximize play/practice time by catching stray shots/passes
- Promote safety
- Reduce damage to neighbor's property/plants
- Fits all First Team pole mounted basketball goals
- Lightweight and easy to install
- Installs in less than 10 minutes
- Lifetime Limited Warranty
- Approx. Shipping Weight: 10 lbs.

FT12 ▶

- Key operated handle lock
- Prevents unwanted adjustment on 4", 5" and 6" EZ-Crank adjustable goal systems
- Zinc plated
- 1-Year Limited Warranty
- Approx. Shipping Weight: 1 lb.

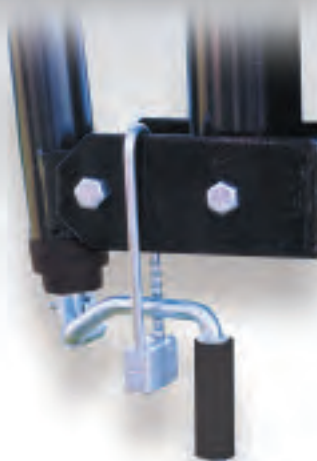

FT50 ▲

- Threaded Socket
- Spring loaded core receives 1/2" bolt
- May be used for tile, concrete or sub surface below floating floors
- Approx. Shipping Weight: 1 lb.



- [FT1400-ACR](#) [FT1625-ACR](#)
[FT1500-ACR](#) [PH05/06-ACR](#)
[FT1600-ACR](#) [PHCHALLENGER-ACR](#)

- Ground Anchor Kit
- Kit includes necessary hardware for relocating respective EZ-Crank adjustable basketball system
- Anchor kit includes J-bolts, template, rebar, hex nuts and instructions
- Approx. Shipping Weight: 15 lbs.

POPASHOT® CLASSIC

HOME ELECTRONIC BASKETBALL GAME



First Team



1/2" Thick Backboard

Heavy 3/8" Steel Rim

Made in USA Electronics For Accurate Scoring

Full Length Side Nets

High Strength PVC Framework

Double Reinforced Ball Return

3 Balls Included

Don't settle for less than The Original POP-A-SHOT

Specifications:

Length - 8'

Width - 30"

Height - 7' 10"

Approx Ship. Wt: 69 lbs.

Bring America's favorite electronic basketball game to your home rec room with First Team's Pop-A-Shot® Classic.

Players try to "beat the clock" shooting baskets in rapid fire succession. Two points per basket, three points for each basket during the final 15 seconds. Score 30 points or better to be awarded extended play!

Top quality construction and made in the USA electronics are a must! So don't be fooled by cheap imitations. Don't settle for less than First Team's original Pop-A-Shot Classic!

POPASHOT® PREMIUM

HEAVY DUTY STEEL ELECTRONIC BASKETBALL GAME



1/2" Thick Backboard

Made in USA Electronics For Accurate Scoring

Heavy Duty Side Nets

Heavy Duty Vinyl Ball Return

Heavy Duty Steel Frame

3 Balls Included

Folds For Easy Transport

Specifications:

Length - 8'

Width - 32"

Height - 7' 10"

Approx Ship. Wt: 100 lbs.

For more demanding commercial applications First Team offers the Pop-A-Shot Premium! If you're looking to bring the fun outside the home, First Team recommends our premium Pop-A-Shot model. Designed with commercial facilities in mind, the Pop-A-Shot Premium sports a folding, 100% steel understructure that is tough as nails.

Players try to "beat the clock" shooting baskets in rapid fire succession. Two points per basket, three points for each basket during the final 15 seconds. Score 30 points or better to be awarded extended play! When it comes to top quality indoor arcade basketball fun, no one's got game like First Team!

Ideal For:

- Churches/Youth Groups
- Boys & Girls Clubs
- Health Clubs
- Premium Residential Rec Room
- Product Promotion
- Trade Shows
- Hotels
- Restaurants

"We use our Pop-A-Shot regularly throughout the year at games and other campus events. It has held up great over the years and is always a huge hit with kids young and old!"
- Art Mullet
A.D. Hesston College

www.firstteaminc.com

First Team, Inc. • Hutchinson, Kansas • Toll-Free 1-800-649-3688

the TEAMMATE™

PORTABLE & FIXED PLAYER BENCHES

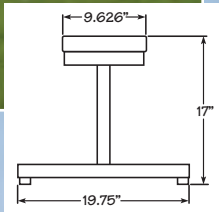
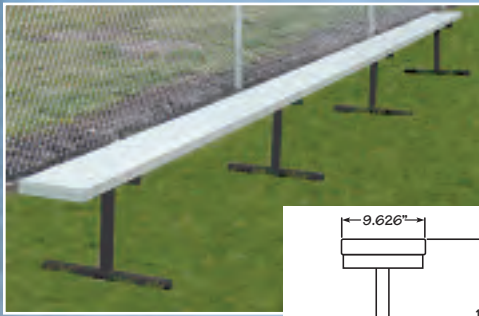

Part #	Description	Weight
TEM-PB-8	Portable Bench 8 Long - Seats 5 No Backrest	.40 lbs.
TEM-PB-15	Portable Bench 15 Long - Seats 10 No Backrest	.65 lbs.
TEM-PB-21	Portable Bench 21 Long - Seats 14 No Backrest	.90 lbs.

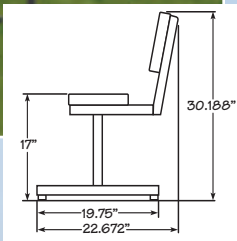

Part #	Description	Weight
TEM-PB-8-B	Portable Bench 8 Long - Seats 5 With Backrest	.70 lbs.
TEM-PB-15	Portable Bench 15 Long - Seats 10 With Backrest	.110 lbs.
TEM-PB-21	Portable Bench 21 Long - Seats 14 With Backrest	.160 lbs.

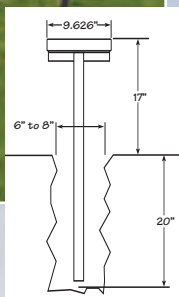
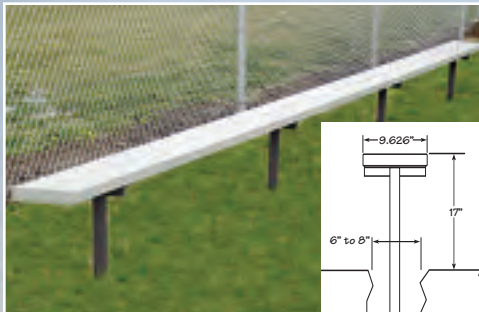

Part #	Description	Weight
TEM-FX-8	Fixed Bench 8 Long - Seats 5 No Backrest	.40 lbs.
TEM-FX-15	Fixed Bench 15 Long - Seats 10 No Backrest	.65 lbs.
TEM-FX-21	Fixed Bench 21 Long - Seats 14 No Backrest	.90 lbs.

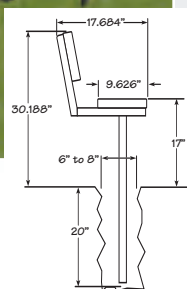
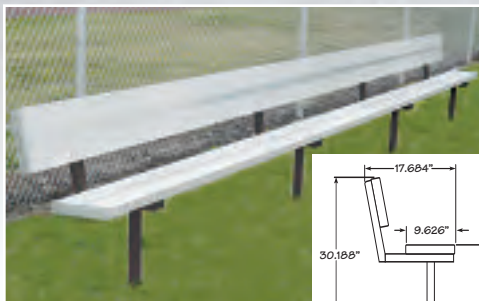

Part #	Description	Weight
TEM-FX-8-B	Fixed Bench 8 Long - Seats 5 With Backrest	.70 lbs.
TEM-FX-15-B	Fixed Bench 15 Long - Seats 10 With Backrest	.110 lbs.
TEM-FX-21-B	Fixed Bench 21 Long - Seats 14 With Backrest	.160 lbs.

First Team introduces the Teammate line of portable and fixed player benches. All Teammate player benches use 9 5/8" x 1 3/4" anodized aluminum planking for seats and backrests. Support legs and backrest brackets are powdercoat painted black, steel construction. Legs are spaced on 6'0" centers. Portable player benches include rubber floor protectors to prevent floor damage.

Teammate player benches are available in 8', 15' and 21' lengths with and without backrests. "Fixed" benches are cemented in ground for a permanent installation, while "Portable" benches are freestanding allowing them to be easily moved. All planks include end caps for a finished look with no sharp edges.

For added school spirit, consider ordering benches in custom colors. First Team can powdercoat seat planks and backrests up to 15' lengths in a variety of colors for a minimal charge. See below for color availability.

Choose the Teammate player bench meets your seating needs. See chart for seating capacity. All Teammate player benches are covered by First Team's Lifetime Limited Warranty!

Seatplanks & backrests available in colors up to 15' lengths.

Available Colors:
Scarlet, Royal Blue, Navy Blue, Forest Green, Kelly Green, Gold, Orange, Purple, White

the

FANSTAND™

INDOOR TIP-N-ROLL BLEACHERS

(2, 3 & 4 ROW)

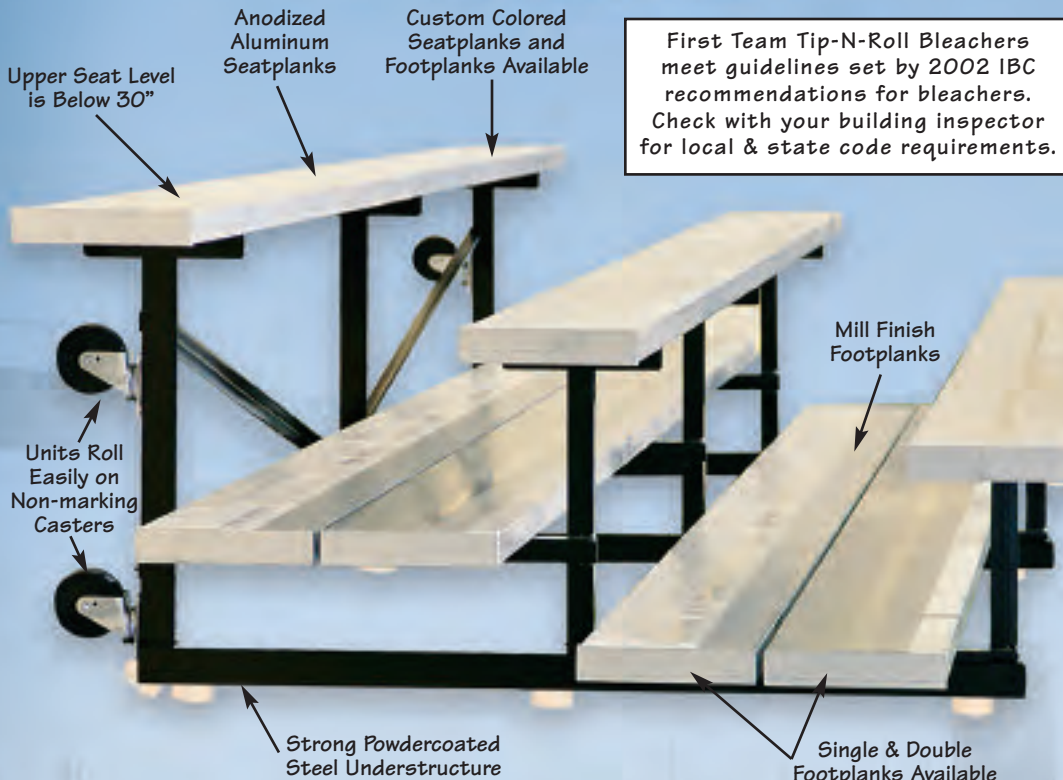

Give your gym seating the versatility you need with First Team's new line of FanStand indoor tip-n-roll bleachers.

First Team's line of indoor tip-n-roll bleachers make providing added spectator seating a breeze. All seats use 9 5/8" x 1 3/4" anodized aluminum planking. Walk planks are 9 5/8" x 1 3/4" mill finished aluminum. FanStand bleachers are available with single or double walk planks. 4" tip n roll wheels are secured to back seat support to make bleachers portable. Simply tilt bleacher backwards onto wheels to roll. First Team's FanStand bleachers are designed so the highest seat level is below 30" above ground level, eliminating the need for safety railing. Basic framing is all welded structural angle with bolted cross bracing to maximize bleacher strength for end shift loads. Framing is spaced on six foot centers. 2 1/2" rubber floor protectors are used on the bottom of frame to protect finished floors. Steel under structure is powder coat painted black.

Choose the FanStand bleacher that meets your seating needs. See chart for seating capacity. All FanStand bleachers are covered by First Team's Lifetime Limited Warranty!

Part #	Description	Seating Cap.	Wt.
FAN2-1FP-TNR-9	... 2-Row, Single Footplank, 9' long	12	115 lbs.
FAN2-2FP-TNR-9	... 2-Row, Double Footplank, 9' long	12	132 lbs.
FAN2-1FP-TNR-15	... 2-Row, Single Footplank, 15' long	20	187 lbs.
FAN2-2FP-TNR-15	... 2-Row, Double Footplank, 15' long	20	214 lbs.
FAN2-1FP-TNR-21	... 2-Row, Single Footplank, 21' long	28	259 lbs.
FAN2-2FP-TNR-21	... 2-Row, Double Footplank, 21' long	28	297 lbs.
FAN3-1FP-TNR-9	... 3-Row, Single Footplank, 9' long	18	177 lbs.
FAN3-2FP-TNR-9	... 3-Row, Double Footplank, 9' long	18	210 lbs.
FAN3-1FP-TNR-15	... 3-Row, Single Footplank, 15' long	30	272 lbs.
FAN3-2FP-TNR-15	... 3-Row, Double Footplank, 15' long	30	326 lbs.
FAN3-1FP-TNR-21	... 3-Row, Single Footplank, 21' long	42	384 lbs.
FAN3-2FP-TNR-21	... 3-Row, Double Footplank, 21' long	42	460 lbs.
FAN4-1FP-TNR-9	... 4-Row, Single Footplank, 9' long	24	230 lbs.
FAN4-2FP-TNR-9	... 4-Row, Double Footplank, 9' long	24	278 lbs.
FAN4-1FP-TNR-15	... 4-Row, Single Footplank, 15' long	40	356 lbs.
FAN4-2FP-TNR-15	... 4-Row, Double Footplank, 15' long	40	437 lbs.
FAN4-1FP-TNR-21	... 4-Row, Single Footplank, 21' long	56	500 lbs.
FAN4-2FP-TNR-21	... 4-Row, Double Footplank, 21' long	56	613 lbs.



Order Double Footplanks for Extra Comfort & Security

Seatplanks & footplanks available in colors up to 15' lengths.

Available Colors:

Scarlet, Royal Blue, Navy Blue, Forest Green, Kelly Green, Gold, Orange, Purple, White

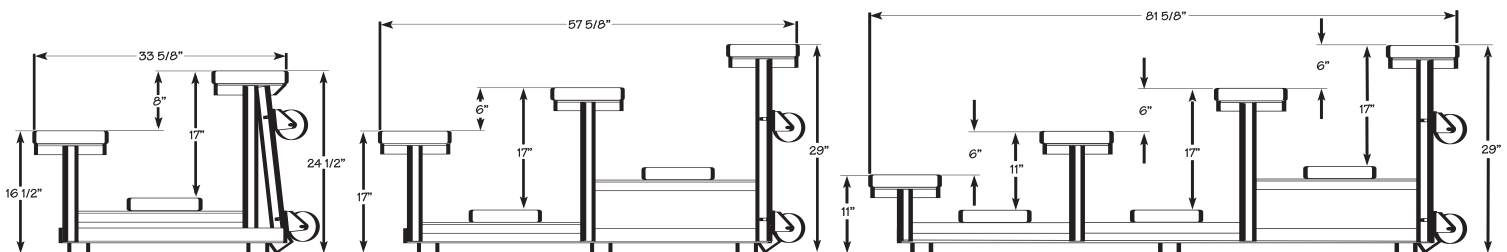

www.firstteaminc.com

First Team, Inc. • Hutchinson, Kansas • Toll-Free 1-800-649-3688

the

FANSTAND™

OUTDOOR BLEACHERS

(2, 3 & 4 ROW)

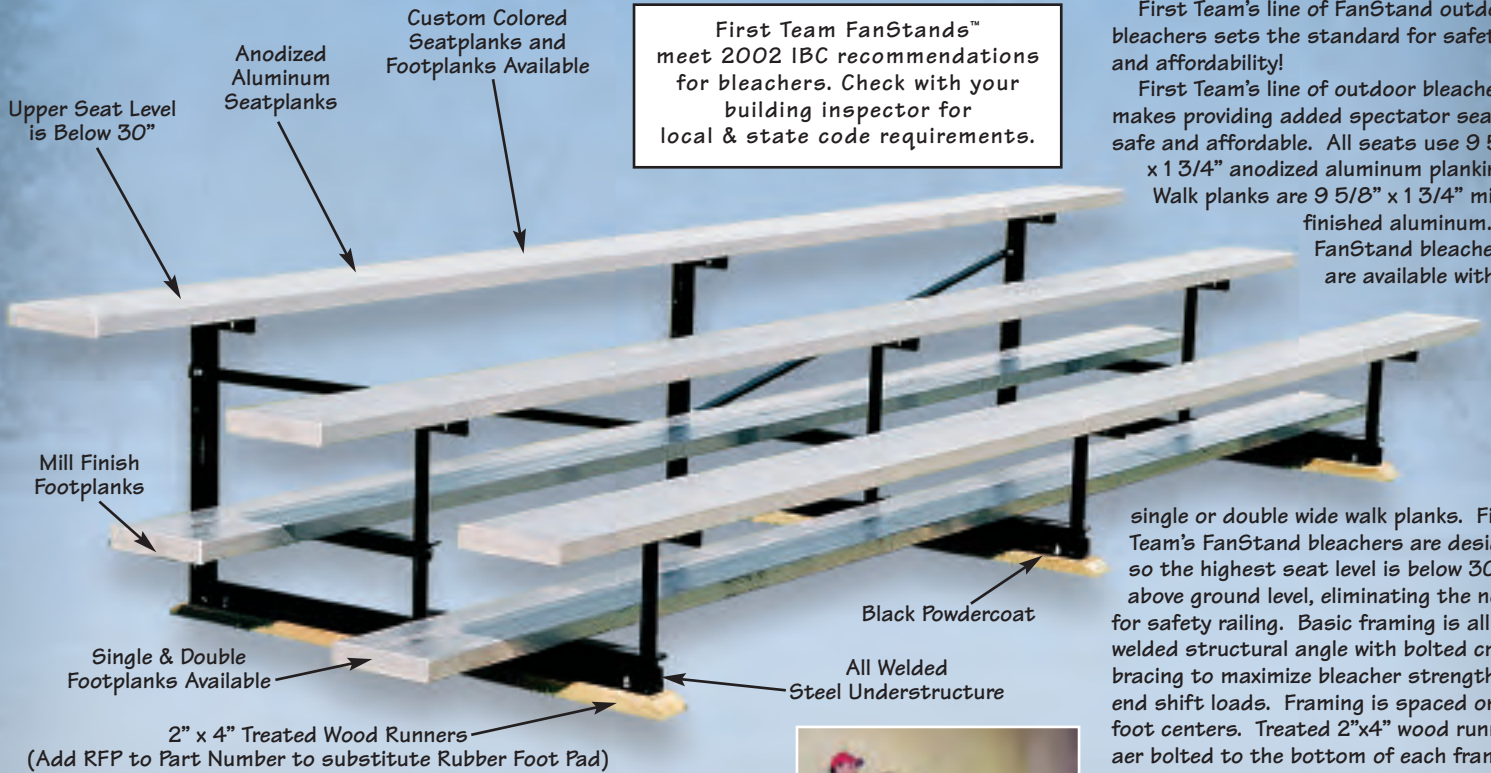

First Team FanStands™ meet 2002 IBC recommendations for bleachers. Check with your building inspector for local & state code requirements.

First Team's line of FanStand outdoor bleachers sets the standard for safety and affordability!

First Team's line of outdoor bleachers makes providing added spectator seating safe and affordable. All seats use 9 5/8" x 1 3/4" anodized aluminum planking. Walk planks are 9 5/8" x 1 3/4" mill finished aluminum. FanStand bleachers are available with

single or double wide walk planks. First Team's FanStand bleachers are designed so the highest seat level is below 30" above ground level, eliminating the need for safety railing. Basic framing is all welded structural angle with bolted cross bracing to maximize bleacher strength for end shift loads. Framing is spaced on six foot centers. Treated 2"x4" wood runners are bolted to the bottom of each frame to provide improved stability on soft surfaces. Rubber foot pads may be substituted upon request. Steel under structure is powder coat painted black.

Choose the FanStand bleacher that meets your seating needs. See chart for seating capacity. All FanStand bleachers are covered by First Team's Lifetime Limited Warranty!



Order Double Footplanks for Extra Comfort & Security

Seatplanks & footplanks available in colors up to 15' length.

Available Colors:
Scarlet, Royal Blue, Navy Blue, Forest Green, Kelly Green, Gold, Orange, Purple, White

Part #	Description	Seating Cap.	Wt.
FAN2-1FP-9	2-Row, Sgl. Footplank, 9' long	12	115 lbs.
FAN2-2FP-9	2-Row, Dbl. Footplank, 9' long	12	132 lbs.
FAN2-1FP-15	2-Row, Sgl. Footplank, 15' long	20	187 lbs.
FAN2-2FP-15	2-Row, Dbl. Footplank, 15' long	20	214 lbs.
FAN2-1FP-21	2-Row, Sgl. Footplank, 21' long	28	259 lbs.
FAN2-2FP-21	2-Row, Dbl. Footplank, 21' long	28	297 lbs.
FAN3-1FP-9	3-Row, Sgl. Footplank, 9' long	18	177 lbs.
FAN3-2FP-9	3-Row, Dbl. Footplank, 9' long	18	210 lbs.
FAN3-1FP-15	3-Row, Sgl. Footplank, 15' long	30	272 lbs.
FAN3-2FP-15	3-Row, Dbl. Footplank, 15' long	30	326 lbs.
FAN3-1FP-21	3-Row, Sgl. Footplank, 21' long	42	384 lbs.
FAN3-2FP-21	3-Row, Dbl. Footplank, 21' long	42	460 lbs.
FAN4-1FP-9	4-Row, Sgl. Footplank, 9' long	24	230 lbs.
FAN4-2FP-9	4-Row, Dbl. Footplank, 9' long	24	278 lbs.
FAN4-1FP-15	4-Row, Sgl. Footplank, 15' long	40	356 lbs.
FAN4-2FP-15	4-Row, Dbl. Footplank, 15' long	40	437 lbs.
FAN4-1FP-21	4-Row, Sgl. Footplank, 21' long	56	500 lbs.
FAN4-2FP-21	4-Row, Dbl. Footplank, 21' long	56	613 lbs.

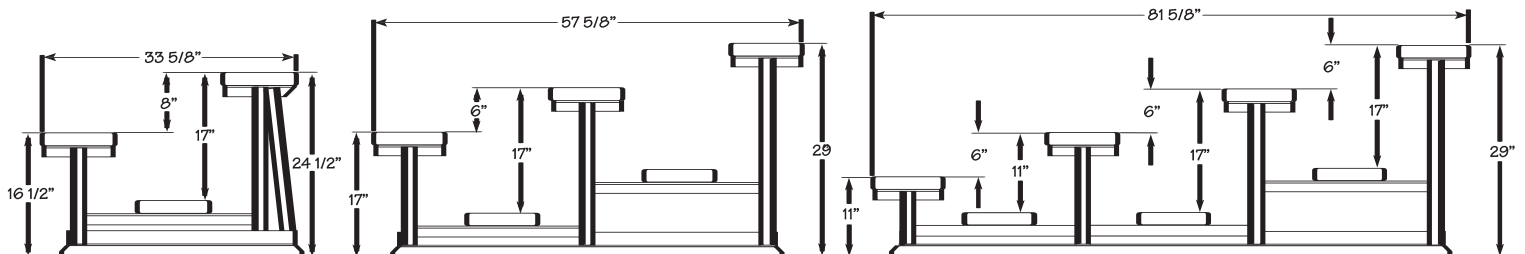

the

CROWDPLEASER™

OUTDOOR BLEACHERS (5, 6, 8 & 10 ROW)



Available in 15', 21' & 27' Lengths

Vertical Slat Safety Rails

No Openings Larger Than 4" on Seats Higher Than 30" from Ground

Aisle Steps With Handrails Included

What does it take to be a crowd pleaser? Safety, Accessibility, Durability, Stability and Affordability are the building blocks of First Team's CrowdPleaser line of outdoor bleachers!

First Team's CrowdPleaser bleachers are designed with the crowd in mind. Double wide walk planks come standard for safety and comfort at all seat levels. All bleacher configurations above 30" have openings of less than 4". Additionally, every CrowdPleaser bank of bleachers includes an aisle with handrails so spectators can easily and safely enter or exit the bleachers. Also, in accordance with 2002 IBC recommendations for bleachers, safety rails along the back and sides are included. For added security, CrowdPleaser safety rails have a "vertical slat" design to discourage children from climbing which is far superior to common "chain link fence" type barriers common on competitors bleachers.

All seats use 9 5/8" x 1 3/4" anodized aluminum planking. Walk planks are 9 5/8" x 1 3/4" mill finished aluminum. Basic

framing up to six rows is all welded structural steel angle with bolted cross bracing to improve bleacher strength for end shift loads.

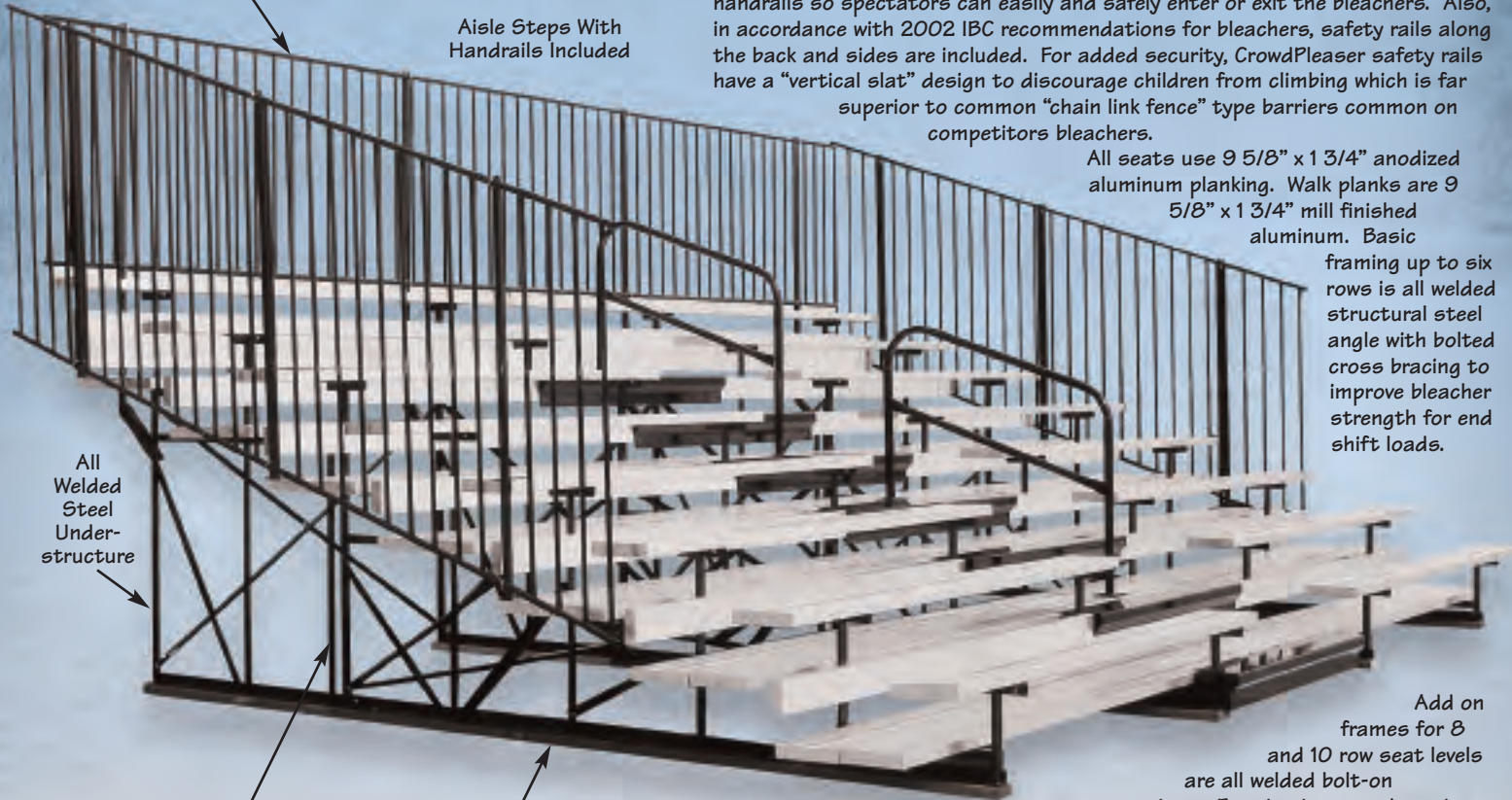

All Welded Steel Under-structure

Powder Coated For Weather Resistance

2" x 4" Treated Wood Runners
(Add RFP to the End of Part Number to substitute Rubber Foot Pad)

Add on frames for 8 and 10 row seat levels are all welded bolt-on extensions. Framing is spaced on six foot centers. Treated 2"x4" wood runners are bolted to the bottom of each frame to provide

improved stability on soft surfaces. Rubber foot pads may be substituted upon request.

For added school spirit, consider custom colors available on seat planks and walk planks up to 15' lengths. See below for available colors. All First Team CrowdPleaser bleachers are covered by First Team's Lifetime Limited Warranty.

If safety, durability, accessibility, stability and affordability are what your looking for to satisfy your home crowd, then you've found it all right here with First Team's CrowdPleaser!

First Team Bleachers Conform to 2002 IBC Design Recommendations. Check With Your Building Inspector for Local and State Codes.

Part #	Description	Seating Cap.	Wt.
CPL-5-2FP-A-15	...5-Row, w/center aisle, 15' length	...42	1205 lbs.
CPL-5-2FP-A-21	...5-Row, w/center aisle, 21' length	...58	1467 lbs.
CPL-5-2FP-A-27	...5-Row, w/center aisle, 27' length	...78	1835 lbs.
CPL-6-2FP-A-15	...6-Row, w/center aisle, 15' length	...50	1465 lbs.
CPL-6-2FP-A-21	...6-Row, w/center aisle, 21' length	...69	1772 lbs.
CPL-6-2FP-A-27	...6-Row, w/center aisle, 27' length	...93	2200 lbs.
CPL-8-2FP-A-21	...8-Row, w/center aisle, 21' length	...91	2532 lbs.
CPL-8-2FP-A-27	...8-Row, w/center aisle, 27' length	...123	3141 lbs.
CPL-10-2FP-A-21	...10-Row, w/center aisle, 21' length	...113	3434 lbs.
CPL-10-2FP-A-27	...10-Row, w/center aisle, 27' length	...153	4236 lbs.

Seatplanks & footplanks available in colors up to 15' lengths.

Available Colors:
Scarlet, Royal Blue, Navy Blue, Forest Green, Kelly Green, Gold, Orange, Purple, White

www.firstteaminc.com

First Team, Inc. • Hutchinson, Kansas • Toll-Free 1-800-649-3688

the

WORLD CLASS™ 40

4" ROUND ALUMINUM PORTABLE SOCCER GOAL



First Team introduces the World Class 40 line of 4" round aluminum portable soccer goals! The World Class 40 line is designed to maximize functionality while keeping budget conscious programs in the game. No other line can claim to offer the value of World Class 40!

All World Class 40 soccer goals are manufactured to exacting standards for true, seamless fit throughout. The 4" round aluminum uprights and crossbar are powdercoated white for an aesthetic appeal. First Team's World Class net fastening system attaches net securely in place. Once in place, World Class net clips will not come loose or get lost. No more velcro straps, welded hooks or nylon ties. Unlike other manufacturers clips, World Class net fasteners will not become loose or cause misalignment of net.

World Class 40 backstays are manufactured of 100% galvanized 1 3/4" round tube and will not rust. Backstays are designed extra deep for added stability and security and include our built in portable wheel feature for ease of transport. All World Class 40 goals meet or exceed ASTM F2056 for tipover and failure requirements. All World Class soccer units meet NCAA, NHSF and FIFA rules.

First Team is also one of the only manufacturers to include a padding compensation feature with all soccer goals. All goals can be assembled at official opening width or extended to compensate for thickness of upright padding if applicable.

World Class 40 goals are sold complete and always include goal structure, backstays, ground bar, transport wheel kits, auger style ground anchors and professional style hexagonal net.



World Class™ Net Attachment



Optional Padding Spacer



Auger Style Ground Anchors



AVAILABLE IN 4 POPULAR SIZES:

- ELITE 24' x 8'
- SR. CLUB 21' x 7'
- JR. CLUB 18.5' x 6.5'
- ELEMENT 12' x 6.5'

FREE Portable Wheel Assembly



FREE! Portable Wheel Assembly Included

Model	Goal Size	Shipping Weight	Warranty
World Class 40 Elite-PB	24'(w) x 8'(h) x 4'(t) x 10'(b)	500#/pair	Lifetime Limited
World Class 40 Sr. Club-PB	21'(w) x 7'(h) x 4'(t) x 7'(b)	490#/pair	Lifetime Limited
World Class 40 Jr. Club-PB	18.5'(w) x 6.5'(h) x 4'(t) x 6.5'(b)	450#/pair	Lifetime Limited
World Class 40 Element-PB	12'(w) x 6.5'(h) x 4'(t) x 6.5'(b)	310#/pair	Lifetime Limited

the WORLD CLASS™ 40

4" ROUND ALUMINUM PERMANENT/SEMI-PERMANENT SOCCER GOAL



First Team introduces the World Class 40 line of 4" round aluminum permanent and semi-permanent soccer goals! The World Class 40 line is designed to maximize functionality while keeping budget conscious programs in the game. No other line can claim to offer the value of World Class 40!

All World Class 40 soccer goals are manufactured to exacting standards for true, seamless fit throughout. The 4" round aluminum uprights and crossbar are powdercoated white for an aesthetic appeal. First Team's World Class net fastening system attaches net securely in place.

Once in place, World Class net clips will not come loose or get lost. No more velcro straps, welded hooks or nylon ties. Unlike other manufacturers clips, World Class net fasteners will not become loose or cause misalignment of net.

All World Class 40 permanent and semi-permanent goals include free 4' European Style backstays giving depth to the goal and net. Semi-permanent packages include our exclusive ground sockets with chrome plated cover lids. And don't forget First Team always includes our heavy duty professional style hexagonal mesh net with every goal!

All World Class 40 goals meet or exceed ASTM F2056 for tipover and failure requirements. All World Class 40 soccer units meet NCAA, NHSF and FIFA rules.

First Team is also one of the only manufacturers to include a padding compensation feature with all soccer goals. All goals can be assembled at official opening width or extended to compensate for thickness of upright padding if applicable.



AVAILABLE IN 4 POPULAR SIZES:

- ELITE 24' x 8'
- SR. CLUB 21' x 7'
- JR. CLUB 18.5' x 6.5'
- ELEMENT 12' x 6.5'

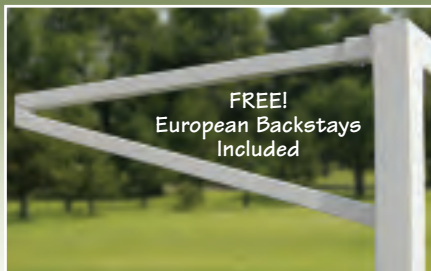

Model	Goal Type	Goal Size	Shipping Weight	Warranty
World Class 40 Elite-PM	Permanent	24'(w) x 8'(h) x 4'(t) x 10'(b)	500#/pair	Lifetime Limited
World Class 40 Sr. Club-PM	Permanent	21'(w) x 7'(h) x 4'(t) x 7'(b)	490#/pair	Lifetime Limited
World Class 40 Jr. Club-PM	Permanent	18.5'(w) x 6.5'(h) x 4'(t) x 6.5'(b)	450#/pair	Lifetime Limited
World Class 40 Element-PM	Permanent	12'(w) x 6.5'(h) x 4'(t) x 6.5'(b)	310#/pair	Lifetime Limited
World Class 40 Elite-SP	Semi-Permanent	24'(w) x 8'(h) x 4'(t) x 10'(b)	520#/pair	Lifetime Limited
World Class 40 Sr. Club-SP	Semi-Permanent	21'(w) x 7'(h) x 4'(t) x 7'(b)	510#/pair	Lifetime Limited
World Class 40 Jr. Club-SP	Semi-Permanent	18.5'(w) x 6.5'(h) x 4'(t) x 6.5'(b)	470#/pair	Lifetime Limited
World Class 40 Element-SP	Semi-Permanent	12'(w) x 6.5'(h) x 4'(t) x 6.5'(b)	330#/pair	Lifetime Limited

www.firstteaminc.com

First Team, Inc. • Hutchinson, Kansas • Toll-Free 1-800-649-3688

the GOLDEN GOAL™ 44

ALUMINUM PORTABLE SOCCER GOAL



First Team introduces the Golden Goal 44 line of portable aluminum soccer goals! The Golden Goal 44 line sets a new standard in the soccer industry for durability, dependability, portability and safety. No other line of soccer goals offers all of the built in features included with these units.



All Golden Goal 44 soccer goals are manufactured to exacting specifications for a true, seamless fit throughout. The 4"x4" square aluminum uprights and crossbar are extruded with a safe 3/4" rounded radius on the corners for safety. The uprights, crossbar and backstay are fully integrated with First Team exclusive "STAY-PUT" net attachment design. With "STAY-PUT" there are no velcro straps, welded hooks, screws, nylon ties or plastic clips. STAY-PUT is the first, fully integrated net attachment

system for soccer. Simply weave the attachment rope into the attachment notches located throughout the goal structure. The net will "STAY-PUT" until you are ready to remove it and there are no clips, etc. to lose or misplace. With STAY-PUT the net always remains tight and true because there are no clips to slide out of place common with other manufacturers lines.

Golden Goal 44 backstays are 100% manufactured of galvanized 2" square tubing that is powdercoated white, making the unit totally rust-proof for premium long-lasting aesthetic appeal. Backstays are reinforced at all corners to prevent weld fatigue common with other brands. All goals meet or exceed ASTM F2056 for tipover and failure requirements. All Golden

Goal 44 soccer units meet NCAA, National High School Federation and FIFA rules.

First Team is also one of the only manufacturers to include a padding compensation feature with all soccer goals. All goals can be assembled at official opening width or extended to compensate for thickness of upright padding if applicable.

Golden Goal 44's are sold complete and always include goal structure, backstays, ground bar, transport wheel kits, auger style ground anchors, and professional style hexagonal net. All Golden Goal 44 soccer goals are covered by First Team's exclusive Lifetime Superior Warranty.

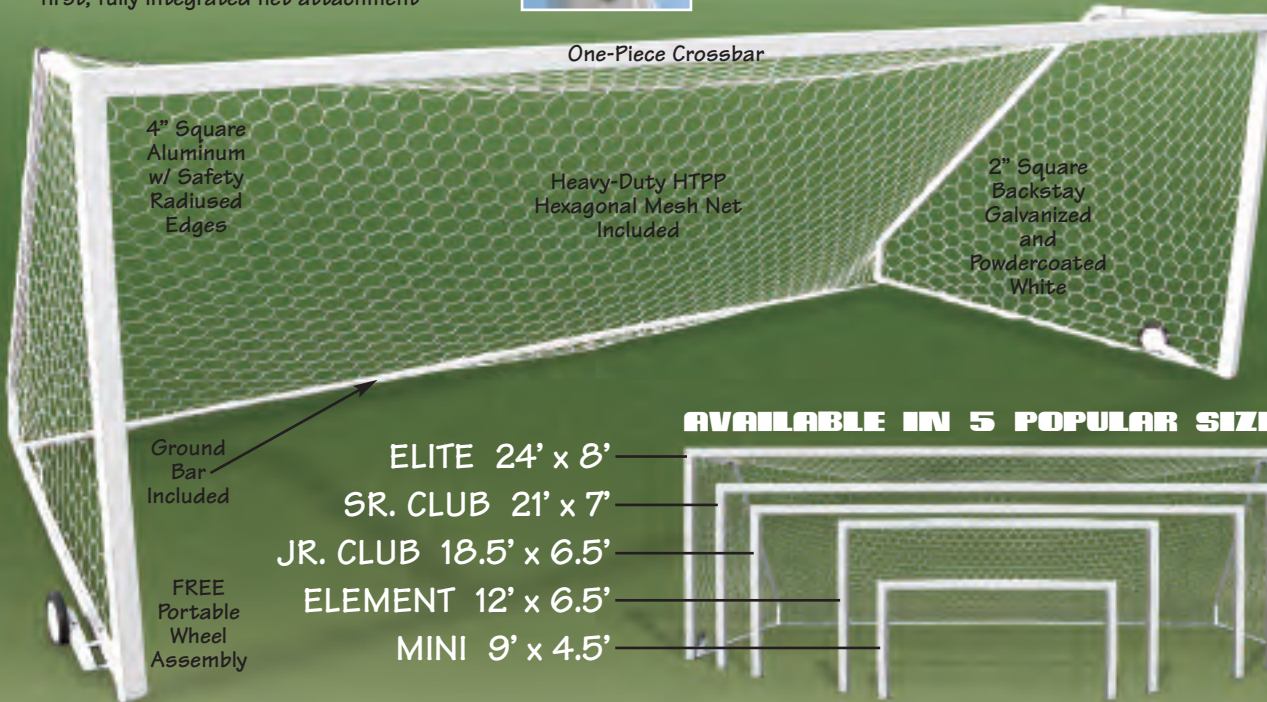

AVAILABLE IN 5 POPULAR SIZES:

- ELITE 24' x 8'
- SR. CLUB 21' x 7'
- JR. CLUB 18.5' x 6.5'
- ELEMENT 12' x 6.5'
- MINI 9' x 4.5'

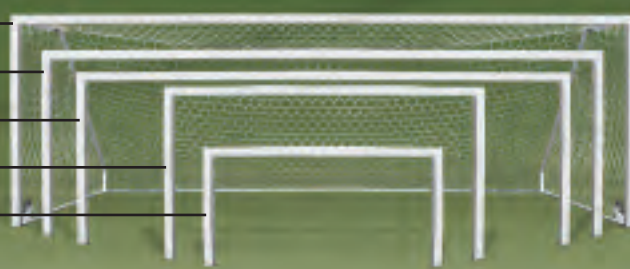

Model	Goal Size	Shipping Weight	Warranty
Golden Goal 44 Elite-PB	24'(w) x 8'(h) x 4'(t) x 10'(b)	500#/pair	Lifetime Limited
Golden Goal 44 Sr. Club-PB	21'(w) x 7'(h) x 4'(t) x 7'(b)	490#/pair	Lifetime Limited
Golden Goal 44 Jr. Club-PB	18.5'(w) x 6.5'(h) x 4'(t) x 6.5'(b)	450#/pair	Lifetime Limited
Golden Goal 44 Element-PB	12'(w) x 6.5'(h) x 4'(t) x 6.5'(b)	310#/pair	Lifetime Limited
Golden Goal 44 Mini-PB	9'(w) x 4.5'(h) x 2'(t) x 4.5'(b)	240#/pair	Lifetime Limited

the GOLDEN GOAL™ 44

ALUMINUM PERMANENT/SEMI-PERMANENT SOCCER GOAL



First Team introduces the Golden Goal 44 line of permanent and semi-permanent aluminum soccer goals! The Golden Goal 44 line sets a new standard in the soccer industry for durability, dependability, and safety. No other line of soccer goals offers all of the built in features included with these units.



All Golden Goal 44 soccer goals are manufactured to exacting specifications for a true, seamless fit throughout. The 4"x4" square aluminum uprights and crossbar are extruded with a safe 3/4" rounded radius on the corners for safety. The uprights and crossbar are fully integrated with First Team's exclusive "STAY-PUT" net attachment design. With "STAY-PUT" there are no velcro, welded hooks, screws, nylon ties or

plastic clips. STAY-PUT is the first, fully integrated net attachment system for soccer. Simply weave the attachment rope into the attachment notches located throughout the goal structure. The net will "STAY-PUT" until you are ready to remove it and there are no clips, etc. to lose or misplace. With STAY-PUT the net always remains tight and true because there are no clips to slide out of place common with other manufacturers lines.

All Golden Goal 44 permanent and semi-permanent units include free European Style backstays for added aesthetic appeal. Semi-permanent packages include our exclusive ground sockets with chrome plated cover lids. Don't forget First Team always includes our heavy duty professional style hexagonal mesh net with every goal!

All goals meet or exceed ASTM F2056 for tipover and failure requirements. All Golden Goal 44 soccer units meet NCAA, National High School Federation and FIFA rules.

First Team is also one of the only manufacturers to include a padding compensation feature with all soccer goals. All goals can be assembled at official opening width or extended to compensate for thickness of upright padding if applicable.

All Golden Goal 44 soccer goals are covered by First Team's exclusive Lifetime Superior Warranty.

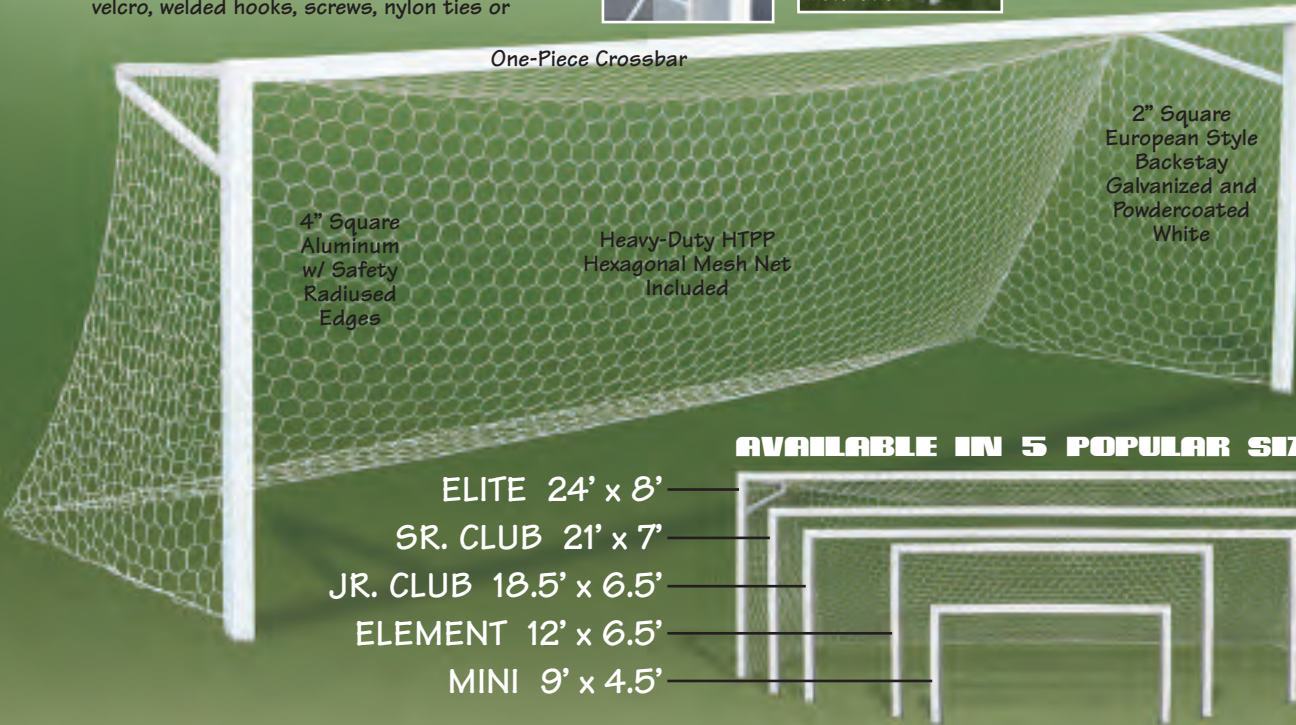
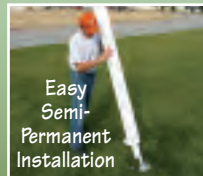

AVAILABLE IN 5 POPULAR SIZES:

- ELITE 24' x 8'
- SR. CLUB 21' x 7'
- JR. CLUB 18.5' x 6.5'
- ELEMENT 12' x 6.5'
- MINI 9' x 4.5'



Model	Goal Type	Goal Size	Shipping Weight	Warranty
Golden Goal 44 Elite-PM	Permanent	24'(w) x 8'(h) x 4'(t) x 10'(b)	500#/pair	Lifetime Limited
Golden Goal 44 Sr. Club-PM	Permanent	21'(w) x 7'(h) x 4'(t) x 7'(b)	490#/pair	Lifetime Limited
Golden Goal 44 Jr. Club-PM	Permanent	18.5'(w) x 6.5'(h) x 4'(t) x 6.5'(b)	450#/pair	Lifetime Limited
Golden Goal 44 Element-PM	Permanent	12'(w) x 6.5'(h) x 4'(t) x 6.5'(b)	310#/pair	Lifetime Limited
Golden Goal 44 Mini-PM	Permanent	9'(w) x 4.5'(h) x 2'(t) x 4.5'(b)	240#/pair	Lifetime Limited
Golden Goal 44 Elite-SP	Semi-Permanent	24'(w) x 8'(h) x 4'(t) x 10'(b)	520#/pair	Lifetime Limited
Golden Goal 44 Sr. Club-SP	Semi-Permanent	21'(w) x 7'(h) x 4'(t) x 7'(b)	510#/pair	Lifetime Limited
Golden Goal 44 Jr. Club-SP	Semi-Permanent	18.5'(w) x 6.5'(h) x 4'(t) x 6.5'(b)	470#/pair	Lifetime Limited
Golden Goal 44 Element-SP	Semi-Permanent	12'(w) x 6.5'(h) x 4'(t) x 6.5'(b)	330#/pair	Lifetime Limited
Golden Goal 44 Mini-SP	Semi-Permanent	9'(w) x 4.5'(h) x 2'(t) x 4.5'(b)	260#/pair	Lifetime Limited

www.firstteaminc.com

First Team, Inc. • Hutchinson, Kansas • Toll-Free 1-800-649-3688

the

FREEKICK

BACKYARD PORTABLE SOCCER GOAL



First Team introduces the FreeKick! The durable 3"x3" uprights and crossbar are powdercoated white for an official look and long term durability. The 1 3/4" galvanized backstays lock into place for rock solid play, yet quickly fold for convenient storage. The FreeKick comes complete with a competition grade net secured to the goal and backstays using our trademarked "Klip-It™" releasable clip design. No more chasing stray soccer balls because of sagging, out of place soccer nets. The FreeKick net will stay in place no matter what. Why settle for cheap, flimsy backyard goals that can't hold their ground? Finally, First Team offers a backyard soccer goal truly designed to perform up to the standards that your home team demands. The FreeKick is the perfect goal for tough backyard matches, spirited church play, daycare centers or anywhere soccer fans gather to play! When it comes time to choose a top quality soccer goal for your backyard, get your kicks with First Team's FreeKick!



Hinged backstays fold flat for easy storage

One-Piece Crossbar

1 3/4" Powdercoated Backstays

Heavy-Duty Competition Grade Net Included

4' Tall x 6' Wide

3" Square Powdercoated Steel Post Construction



Klip-It™ Net Attachment

Lifetime Limited Warranty 

www.firstteaminc.com

First Team, Inc. • Hutchinson, Kansas • Toll-Free 1-800-649-3688

MISCELLANEOUS SOCCER ACCESSORIES

SOCCER NETS



Model #	Mesh Diameter	Width	Height	Top Depth	Bottom Depth	Shipping Weight
FT4024N	3MM	24'	9'	4'	10'	11 lbs. / each
FT4021N	3MM	21'	7'	4'	7'	7 lbs. / each
FT4018N	3MM	18.5'	6.5'	4'	6.5'	6 lbs. / each
FT4012N	3MM	12'	6.5'	4'	6.5'	5 lbs. / each
FT4009N	3MM	9'	4.5'	2'	4.5'	3 lbs. / each
FT4006FKN	3MM	6'	4'	0'	3'	3 lbs. / each

- Heavy duty high tenacity polypropylene (HTPP)
- Professional style hexagonal mesh
- Non-abrasive knotless netting
- White mesh with heavy perimeter attachment rope
- Usable with other brand soccer goals with similar dimensions
- Nets not returnable once opened
- Two Year Limited Warranty

FT4025

- Official soccer corner flags
- One piece official corner flags
- 1" diameter white PVC with red flag
- Spring-loaded for player safety
- Push in ground anchor
- Set of 4
- Approx. shipping weight 20 lbs. UPS

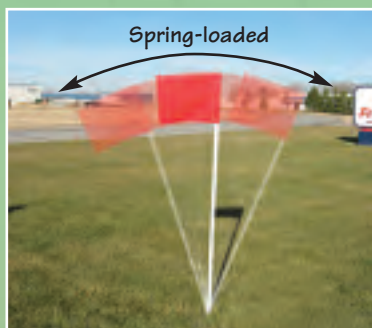

FT5001

- Ground socket for semi-permanent goals
- Included with every Golden Goal Semi-Permanent Soccer Package
- Exclusively for Golden Goal soccer goals
- Chrome plated cover keeps out dirt and debris
- Mower safe
- Order two per goal
- Approx. shipping weight 18 lbs. UPS



FT4034

- 4' European Style Backstays
- Included FREE with every Golden Goal Permanent/Semi-Permanent Soccer Package
- Can be used with other brands of soccer goals (requires drilling)
- Maintains 4' back depth for soccer nets
- Sold in pairs, order (1) pair per goal
- Approx. shipping weight 40 lbs./pair, Truck

FT4032 (Not shown)

- 2' European Style Backstays
- Same features as FT4034 except:
- Maintains 2' back depth for soccer nets
- Approx. shipping weight 20 lbs./pair, Truck

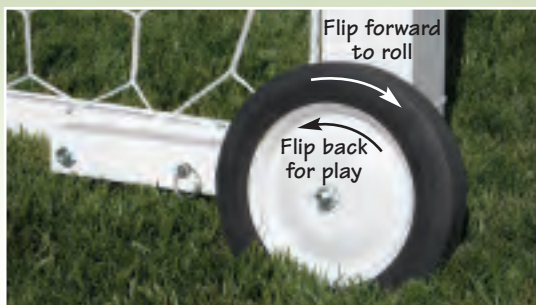

FT4026

- Wheel kit for portable soccer goals
- Included with every First Team portable soccer goal
- Can be used with other brands, requires drilling for use on other brands
- Reduces stress and breakage caused by dragging goals
- Flips forward for easy transport, flips back for play
- 10" transports wheels
- Sold as set of two (outfits one soccer goal)
- Approx. shipping weight 33 lbs. UPS

MISCELLANEOUS SOCCER ACCESSORIES



FT4048S

- Soccer post upright padding
- Protects players from contact with uprights
- 1" thick padding 48" tall section
- Fits 4"x4" square uprights
- Can be combined with our FT4030S padding to cover virtually any goal height
- Will not affect ball rebound off posts
- Sold in pairs
- Approx. shipping weight 10 lbs./pair UPS

FT4030S (Not shown)

- Soccer post upright padding
- Same features as FT4048S except 30" tall
- To be used in combination with FT4048S to pad virtually any goal height
- Sold in pairs
- Approx. shipping weight 10 lbs./pair UPS



FT4027

- Soccer goal ground anchors
- Auger type anchors
- Superior to ground stakes for goal anchoring
- Provided standard with all First Team portable soccer goals
- Set of (2) anchors, use (2) per goal
- Approx. shipping weight 5 lbs. UPS



FT4028

- Net stakes for permanent/semi-permanent soccer nets
- Set of (8) net stakes
- Hold net tightly and securely to ground
- Included with each First Team permanent or semi-permanent soccer goal
- Use 2 per side and 4 across back of net
- Approx. shipping weight 5 lbs. UPS

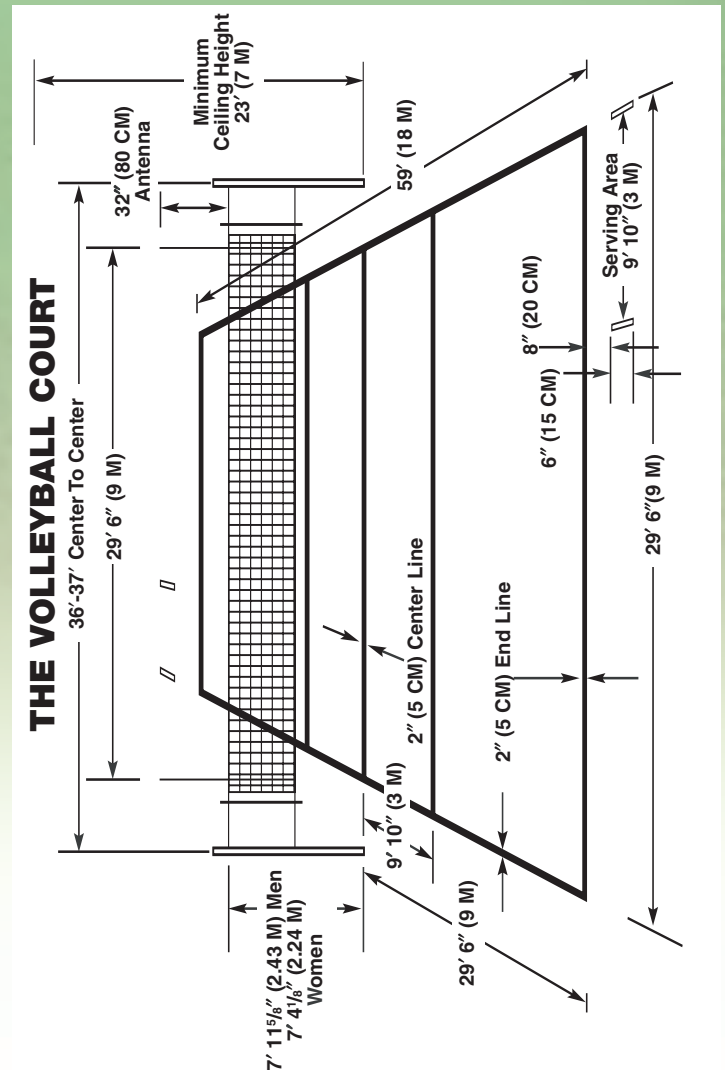
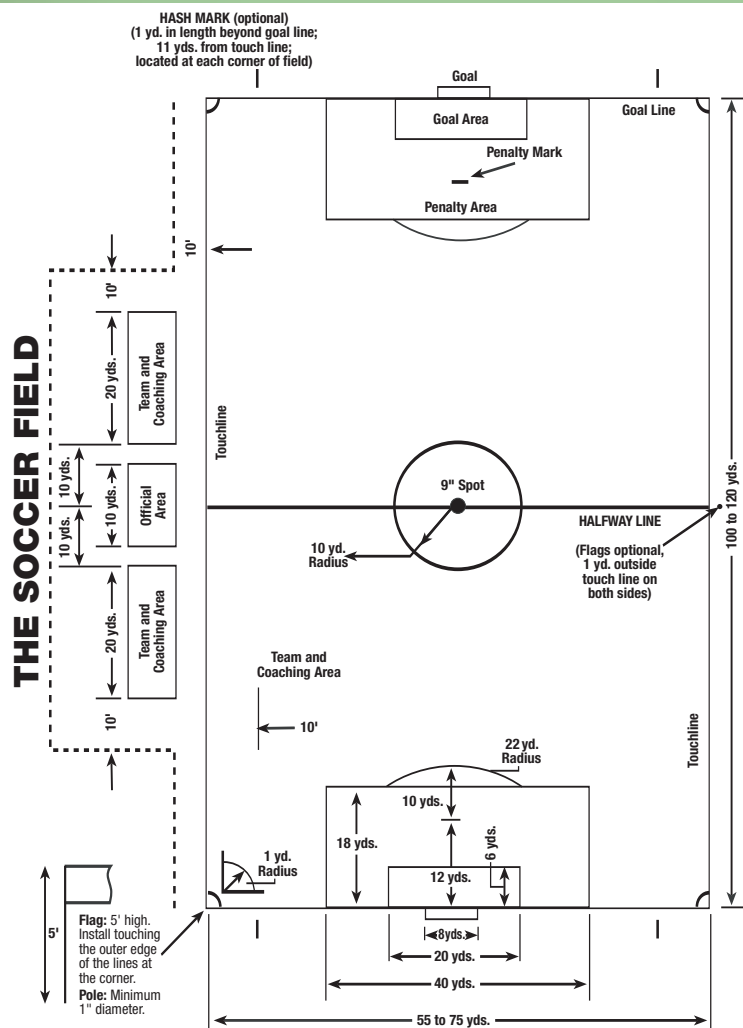

The FRONTIER

STEEL COMPETITION VOLLEYBALL SET



Now With
FREE LETTERING

The Frontier steel competition volleyball system offers exceptional net and post rigidity at a price that will maximize your budget! Steel volleyball uprights have long been the popular standard when it comes to maintaining bowstring tight net tension. Though advances have been made with lightweight titanium standards, steel is still the most economical way to get competition quality net tensioning.

Typical steel standards from other manufacturers are heavy and difficult to set up and take down. This is not the case with First Team's Frontier system! Though Frontier's uprights are constructed of thick 1/4" wall steel tubing, the Frontier is the only volleyball system constructed with it's own built in transport wheel on each post. The transport wheel makes moving and setup a snap. Simply roll each upright to it's respective floor socket and drop post into place, no lifting required!

All Frontier packages come complete with a wormgear crank net tensioner that will not backdrive and is the safest in the industry. The telescoping pistons are spring loaded for simple, quick net height adjustments from 78" to 98" for all levels of play. The net height is shown on the built in net height indicator. Each system comes with a top quality knotless mesh competition net made with Kevlar. First Team competition antennae set comes standard. Upright padding is included in you choice of 12 colors, padded rope covers and chain net height gauge are also included.

The entire system meets all NCAA, National High School Federation and USVBA rules.

All Frontier systems are covered by First Team's Lifetime Limited Warranty.



FREE LETTERING WITH PURCHASE OF VOLLEYBALL SYSTEM



BUILT-IN TRANSPORT WHEEL!



Side-By-Side Systems Available

Model	Description	Shipping Weight	Warranty
Frontier Complete	Complete System described above (Includes sockets)	220#	Lifetime Limited
Frontier Complete-SBS Side-by-Side	Complete side-by-side double court system (Includes sockets)	310#	Lifetime Limited
Frontier Express	Same system as Frontier Complete excluding floor sockets	200#	Lifetime Limited
Frontier Express-SBS Side-by-Side	Same side-by-side system as Frontier Complete-SBS excluding floor sockets	290#	Lifetime Limited



Frontier upright padding is available in these colors. Shades may vary slightly from color chart.

www.firstteaminc.com

First Team, Inc. • Hutchinson, Kansas • Toll-Free 1-800-649-3688

the ASTRO

ALUMINUM COMPETITION VOLLEYBALL SET



First Team's Astro competition volleyball set makes lightweight, high performance volleyball affordable!

The Astro volleyball set is constructed of 3 1/2" x 1/4" wall high strength aluminum. Net is tensioned with our high grade precision wormgear crank with folding handle. First Team's wormgear net tensioning crank is exceptionally safe with no "backdrive" common with inferior net tensioners. Net height adjustments from 78" to 98" are quick and easy using our internal spring telescoping piston design. Slide the inner telescoping tube up or down and turn knob to secure. Net heights are displayed on the telescoping tube as shown in photo.

Each Astro volleyball system includes 3 1/2" uprights, net tensioner, our top of the line competition volleyball net made with KEVLAR, protective rope covers, antennae set, chain net height gauge and upright padding. Upright padding is available in 16 colors shown below. And don't forget, when you purchase an Astro volleyball system First Team will custom letter the upright padding at no extra charge!

The entire system meets all NCAA, National High School Federation and USVBA rules. All Astro volleyball systems are covered by First Team's Lifetime Limited Warranty.

Now With **FREE LETTERING**

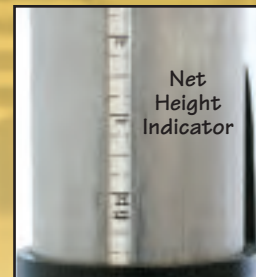

Net Height Indicator



Wormgear Net Tensioning Crank



Bottom Rope Tensioner & Rope Covers

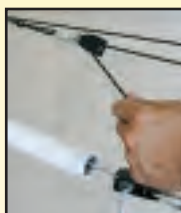

Side Tape Tensioners



Side-By-Side Systems Available



FREE LETTERING WITH PURCHASE OF VOLLEYBALL SYSTEM

Model	Description	Shipping Weight	Warranty
Astro Complete	Complete System described above (Includes sockets)	160#	Lifetime Limited
Astro Complete-SBS Side-by-Side	Complete side-by-side double court system (Includes sockets)	245#	Lifetime Limited
Astro Express	Same system as Astro Complete excluding floor sockets	130#	Lifetime Limited
Astro Express-SBS Side-by-Side	Same side-by-side system as Astro Complete-SBS excluding floor sockets	215#	Lifetime Limited



Astro upright padding is available in these colors. Shades may vary slightly from color chart.

the GALAXY

TITANIUM COMPETITION VOLLEYBALL SET



First Team introduces the GALAXY! The latest in innovative, high performance volleyball standards. The 3 1/2" diameter uprights are constructed entirely of 100% Titanium alloy! Titanium is the key, strong as steel and light as aluminum. Now elite volleyball programs can have it all, equipment that is lightweight and easy to set up without sacrificing upright rigidity or net tensioning.

Titanium has been used for many years in a variety of industries. Titanium has been used for such things as bicycle frames, golf clubs, submarines and aircraft. First Team is the first and only manufacturer to provide volleyball systems made with this superior alloy. The Galaxy volleyball system is truly **AS STRONG AS STEEL AND AS LIGHT AS ALUMINUM!**

The Galaxy comes complete with a wormgear crank net tensioner that will not backdrive and is the safest in the industry. The telescoping pistons are spring loaded for simple, quick net height adjustments from 78" to 98" for all levels of play. The net height is shown on the built in net height indicator. Each system comes with a top quality knotless mesh competition net made with Kevlar. First Team competition antennae set comes standard. Upright padding is included and available in 12 colors. Padded rope covers and chain net height gauge are also included.

The entire system meets all NCAA, National High School Federation and USVBA rules.

All Galaxy volleyball systems are covered by First Team's Lifetime Superior Warranty.

The Galaxy is simply the best volleyball system on the market today!

Now With **FREE LETTERING**

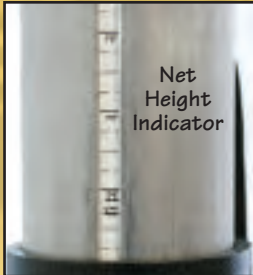

AS STRONG AS STEEL AND AS LIGHT AS ALUMINUM!



FREE LETTERING WITH PURCHASE OF VOLLEYBALL SYSTEM

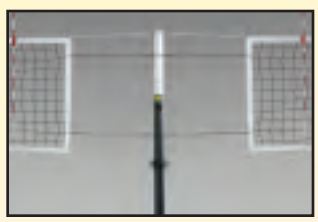

Side-By-Side Systems Available



Side Tape Tensioners

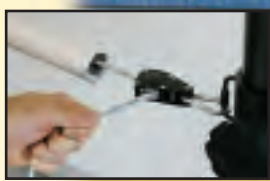

Bottom Rope Tensioner & Rope Covers



Model	Description	Shipping Weight	Warranty
Galaxy Complete	Complete System described above (Includes sockets)	150#	Lifetime Superior
Galaxy Complete-SBS Side-by-Side	Complete side-by-side double court system (Includes sockets)	230#	Lifetime Superior
Galaxy Express	Same system as Galaxy Complete excluding floor sockets	130#	Lifetime Superior
Galaxy Express-SBS Side-by-Side	Same side-by-side system as Galaxy Complete-SBS excluding floor sockets	210#	Lifetime Superior



Galaxy upright padding is available in these colors. Shades may vary slightly from color chart.

www.firstteaminc.com

First Team, Inc. • Hutchinson, Kansas • Toll-Free 1-800-649-3688

the BLAST

STEEL RECREATIONAL VOLLEYBALL SET



First Team introduces the Blast indoor/outdoor volleyball system. First Team's Blast volleyball systems are designed to offer high quality performance, durability, versatility and safety all in one affordable package.

The 4" square steel powdercoated uprights can be installed outdoors for either sand or grass volleyball courts. The Blast also makes a great recreational indoor system for churches or YMCA's or anywhere groups gather to play. The infinitely adjustable net height from 7' 11 5/8" (men's competition height) down to 3' (tennis net height) makes the Blast a great unit for all ages and all types of net games. Our simple net tensoning device makes setting up the unit quick and easy providing competition level net tensoning.

Installation can be permanent by cementing posts in place, or post can be made removable when used with our indoor/outdoor ground sockets for gym floors and grass courts. For sand courts where post removal is desired, we recommend purchasing our FT16 sockets for sand.

First Team offers the Blast volleyball system in an array of configurations. Select from packages with or without padding, floor sockets, sleeves, etc. All Blast volleyball systems are covered by First Team's Lifetime Limited Warranty. When you are searching for the best in affordable volleyball systems, choose First Team and have a BLAST!

FREE

Pad Lettering With Purchase Of Volleyball System



Simple Net Tensioning



Quick Net Adjustment



Floor Sockets



Net Height Indicator



Model	Description	Shipping Weight	Warranty
Blast Complete	Complete System described above (Includes floor/ground sockets)	250#	Lifetime Limited
Blast Express	Same system as Blast Complete excluding sockets	230#	Lifetime Limited
Blast Basic	Same system as Blast Complete excluding floor sockets, padding and antennas	200#	Lifetime Limited
Sand Blast Complete	Same system as Blast Complete except includes FT16 sleeves for sand instead of floor/ground sockets	330#	Lifetime Limited



Blast upright padding is available in these colors. Shades may vary slightly from color chart.

the QUICKSET

STEEL RECREATIONAL VOLLEYBALL SET



First Team's QuickSet provides quality net play and quick set-up without use of hazardous guy-wires! The QuickSet is the finest backyard volleyball set in its price range. The 2" square uprights are powdercoated black for competition styling. The galvanized upper sections telescope up and down to allow play at any height, men's, women's or junior. The QuickSet comes with the same high quality net and net tensioning device used on our higher end Blast systems.

Choose from two QuickSet configurations to meet your specific needs. The QuickSet-PM comes with our permanent ground stems that can be cemented in place providing a solid, permanent net installation. The QuickSet-SP is a great choice when post removal is desired. The QuickSet-SP includes our ground/floor sockets that can be installed in any indoor or outdoor location, allowing removal of the posts for storage. All systems include competition grade upright padding, available in an array of colors.

If your looking for an economical backyard volleyball system that out performs the rest, get ready, get set, QuickSet!

All QuickSet volleyball systems are covered by First Team's Lifetime Limited Warranty.

FREE
Pad Lettering With
Purchase Of
Volleyball System



QuickSet-SP Includes
Ground/Floor Sockets
(Sockets not recommended
for sand courts)



Model	Description	Shipping Weight	Warranty
QuickSet-SP	Complete System described above (Includes floor/ground sockets)	130 #	Lifetime Limited
QuickSet-PM	Same system as QuickSet-SP excluding floor sockets	100 #	Lifetime Limited
QuickSet-NP	Same system as QuickSet-PM excluding post pads	80 #	Lifetime Limited



QuickSet upright padding is available in these colors. Shades may vary slightly from color chart.

www.firstteaminc.com

First Team, Inc. • Hutchinson, Kansas • Toll-Free 1-800-649-3688

the ROLLABLAST

PORTABLE RECREATIONAL VOLLEYBALL SYSTEM



First Team introduces the RollaBlast! For facilities where floor sockets or floor anchors are not desired or not possible, the RollaBlast is a great option for your premium recreational volleyball court requirements.

Far superior to common lightweight tip and roll type volleyball standards, RollaBlast is capable of true, competition grade net tension. The unit is fully self-contained and can be set up by one person in less than 5 minutes. The base units easily roll into place and can be locked into position by raising the 4" square posts to an upright position with the post actuator. Anti-skid bar in front prevents slipping on all flooring types. Net and net tensioner are the same high quality parts used on our popular premium recreational Blast indoor/outdoor standards. Net height adjustments from 78" to 98" are quick and easy. Turn the knob and slide collar to appropriate net height. Net height is shown on built in net height gauge on back of each post.

Each unit includes, two portable base units, two upright posts, net tensioner, competition volleyball net made with KEVLAR, antennae set, two sets of base padding and upright post pads. Entire system is covered by First Team's Limited Lifetime Warranty.

So if you facility demands a totally freestanding portable volleyball system, choose the best and let the good times roll with RollaBlast!

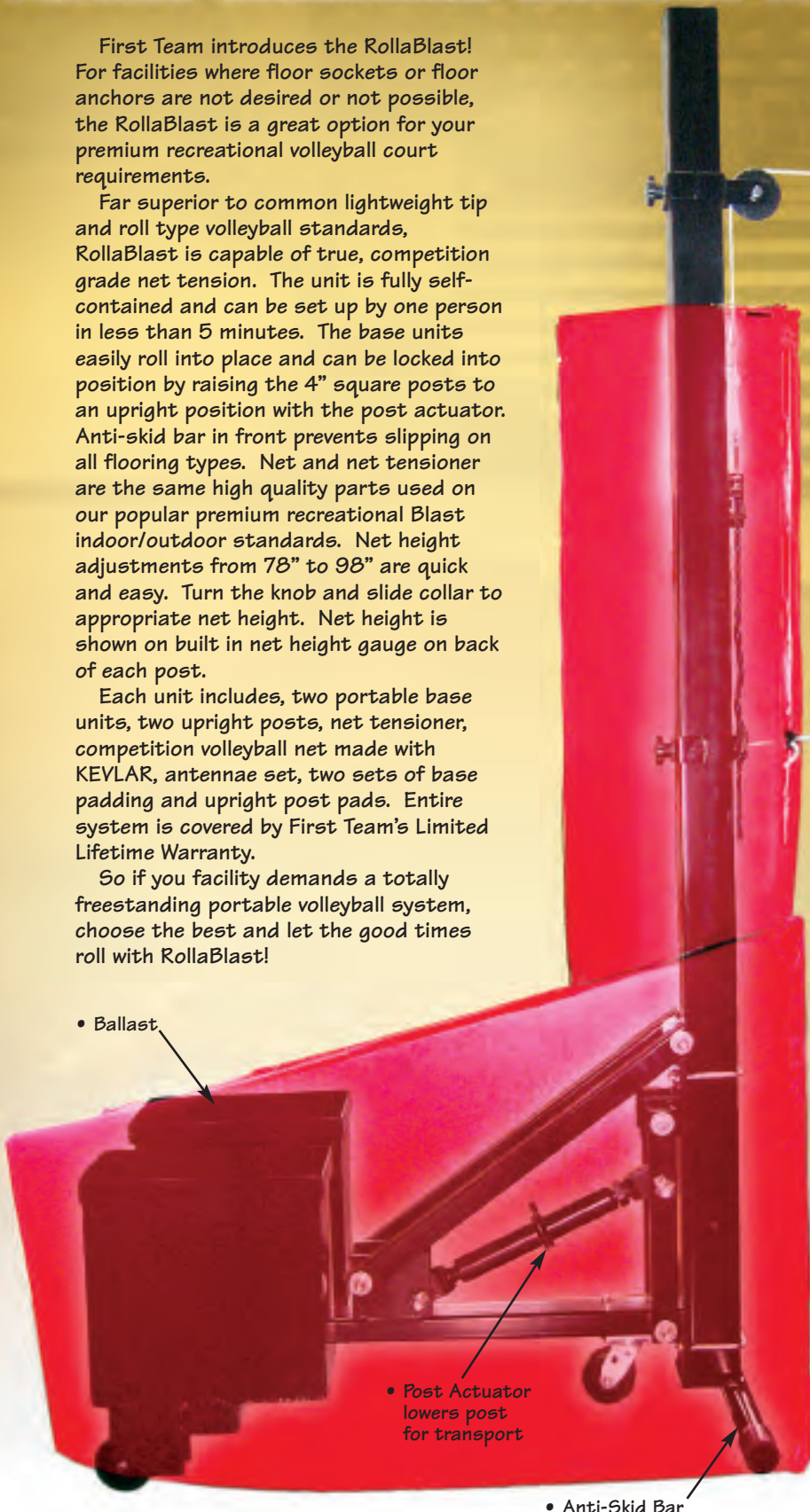

• Ballast

• Post Actuator lowers post for transport

• Anti-Skid Bar



Easy-to-Read Net Height Gauge

Quick & Simple Net Tensioning

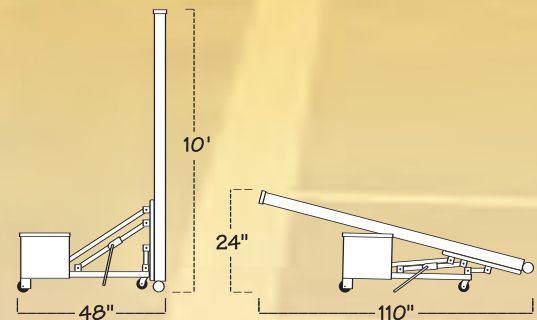

RY Royal Blue	SC Scarlet	GL Gold	PR Purple
KG Kelly Green	BK Black	CB Columbia Blue	MR Maroon
GR Grey	NB Navy Blue	OR Orange	FG Forest Green
BR Brick Red	SO Sienna Orange	DG Desert Gold	SB Saddle Brown

RollaBlast base & stem padding is available in these colors. Shades may vary slightly from color chart.

VOLLEYBALL

ACCESSORIES

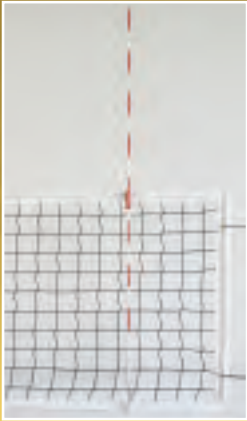

◀ FT5004

- Competition Volleyball Antennae
- Preferred by top programs
- One-piece antennae
- Clamps to any 1 meter / 36" tall net
- Quick twist attachment
- Official 72" x 3/8" fiberglass rod
- Outfits one net
- Attaches without use of ladder or stool
- 1 Year Limited Warranty
- Shipping weight 3 lbs.



◀ FT5300CH

- Blast Clamp Hardware Only
- Clamp set can be used with any 4"x4" square steel or wooden posts
- Perfect for budget conscious programs looking to save
- Includes net clamps, pulley wheel, clamp tensioning knobs and net tensioners
- Shipping weight 14 lbs. each



◀ FT5001

- 3 1/2" Chrome Floor/Ground Socket
- Designed for use with 3 1/2" diameter volleyball uprights
- Chrome plated hinged floor plate
- 10" deep
- For use on floating wooden floors, synthetic/tile floors or plain concrete floors
- Also works as a mower safe socket for outdoor grass or concrete courts
- Requires two sockets per system
- CAUTION! Floor sockets are difficult and often impossible to install on floors with basements or hollow cavities below. Consult an experienced installer for assistance.
- Shipping weight 10 lbs. each



◀ FT5005

- Replacement Volleyball Winch
- Wormgear style crank net tensioner
- Safe, will not backdrive
- Secures to any 3" or 3 1/2" round diameter volleyball post
- 5 Year Limited Warranty
- Shipping weight 5 lbs.



◀ FT5002

- Kevlar Competition Volleyball Net
- Designed specifically for First Team Galaxy and Frontier volleyball systems
- 1/4" No stretch Kevlar top rope
- Knotless woven webbing for tighter net tensioning and a more professional look
- Bright white top, bottom and side tapes
- 32' x 1 meter official size
- 2 Year Limited Warranty
- Shipping weight 15 lbs.



◀ FT5010-XX

- Competition Grade Volleyball Post Padding
- Provided with all Galaxy, Frontier and select Blast volleyball packages
- Meets NCAA, USVBA and National High School Federation rules
- Fits First Team as well as other manufacturers systems
- 1 1/2" thick high density foam with velcro closure
- Protects to 6' height
- Available in 12 colors
- Sold in pairs (outfits one complete volleyball system)
- LTR 5010 Pad Lettering available (10 letters max)
- 5 Year Limited Warranty
- Shipping weight 20 lbs.

See Custom Lettering Section For How To Order Padding Lettering, Or Call First Team



◀ FT5003

- Net Side Tensioners
- Included with First Team Galaxy and Frontier volleyball sets
- Easy ratchet design pulls tight, with push button release
- Quick, easy and safe
- Set of four tensioners
- Shipping weight 1 lb.

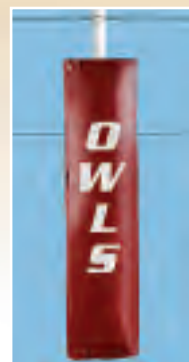

◀ FT5010CP-XX

- Center Post Padding for Side-By-Side volleyball systems
- Same as our FT5010 padding except has velcro closure on both sides allowing center post to accommodate nets on both sides of post.
- Provided standard with First Team side-by-side packages
- Sold individually
- LTR 5010CP Pad Lettering available (10 letters max)
- 5 Year Limited Warranty
- Shipping weight 10 lbs.

VOLLEYBALL ACCESSORIES

FT5011

- Net Cable Covers
- Provided standard with all Galaxy and Frontier volleyball systems
- Fits any manufacturers system
- 18" long padding protects players from contact with volleyball net cables
- Set of four covers
- Shipping weight 1 lb.



SturdiStand

- Folding Padded Volleyball Judges Stand
- Most stable judges stand available
- Easy one person transport and set up
- Meets all NCAA, National High School Federation and USVBA rules
- Easy pull-pin folding design for minimal storage size
- Durable powdercoat finish
- Non-marking wheels and floor pads
- Heavy vinyl covered foam padding included
- Choose from 12 padding colors
- High railing for maximum official safety
- 5 Year Limited Warranty
- Shipping weight 150 lbs.



FT5012-XX
Padding
Included



FT5020

- Volleyball Drill Cart
- Great for conducting drills in practice/warm-ups
- Durable yet lightweight
- Folds for easy storage
- Includes carrying case
- Measures 48"L x 22"W x 12"D x 40"H
- Holds approximately 30 balls
- Shipping weight 15 lbs.
- 1 Year Limited Warranty

FT5013

- Net Setter Chain-Style Net Height Gauge
- Easy, compact chain style net height measurement
- Multiple indicators for all common net heights
- Provided with all Galaxy and Frontier volleyball systems
- Shipping weight 1 lb.



FT15

- Economy Ball Carrier
- 3-Tier ball carrier
- Hold 15 volleyballs
- Easy ball retrieval
- Constructed of 1" diameter chrome plated steel
- Includes four swivel casters
- Doubles as a basketball carrier
- Shipping weight 13 lbs.
- 1-Year Limited Warranty



FT5014

- Precise Height Net Height Gauge
- Precision net height measurement
- Best net height gauge available
- Preferred by top programs
- Telescoping aluminum
- Net height markings on pole for all common net heights
- Shipping weight 2 lbs.



FT5015

- Outdoor Volleyball Boundary Kit
- Bright Yellow 1/4" polypropylene rope
- Corner ties and center court marking
- Heavy duty plastic corner stakes
- Measures 30'x60'
- Can be used on grass or sand
- Shipping weight 4 lbs.



Ball Hog™ Premium Ball Carrier

FT24

- Super Duty Volleyball Carrier
- Holds 30 volleyballs
- Large non-marking casters for "No-Tip" rolling
- Tote handle for easy transport
- Doubles as a basketball carrier
- Approx. Shipping Weight; 92 lbs.



BASKETBALL EQUIPMENT WARRANTY INFORMATION:

All First Team basketball products are warranted against manufacturers defects at delivery. Additionally, First Team warrants most products to the original retail customer for a given period of time as stated in the literature. Below is an explanation of First Team's warranty levels.

Limited Warranty -

Covers any damage caused by normal basketball activity and normal player contact with the goal. "Normal basketball activity" and "Normal player contact" shall be described as any action that is necessary for participation in the game of basketball. Deliberate hanging on the rim, multiple player hanging, and vandalism are not covered under the Limited Warranty.

Superior Warranty -

Covers any damage or failure caused by any type of basketball activity or related contact with the unit. This includes deliberate hanging on the rim as well as multiple player hanging. The Superior Warranty does not cover vandalism.

Unconditional Warranty -

Covers any damage or failure that occurs for any reason. Any product carrying an Unconditional Warranty is exempt from the above stated limitations.

Any normal wear and tear caused by weathering or UV exposure is not covered under any First Team warranty. All painted items carry a one year limited warranty on coating.

Some basketball products carry a warranty valid only when used in a residential setting. "Residential" is defined as a "single family dwelling." Products covered by this warranty stipulation are indicated in First Team's product literature with a  symbol next to the warranty. Under no circumstances shall any basketball product carrying a strictly residential warranty be covered for non-residential use.



SOCCER EQUIPMENT WARRANTY INFORMATION:

All First Team soccer products are warranted against manufacturers defects at delivery. Additionally, most products are warranted to the original retail customer for a given period of time as stated in the literature. Below is an explanation of First Team's warranty levels for soccer products.

Limited Warranty -

Covers any damage or failure that occurs during the course of "normal or intended use" of the product. Normal or intended use of the product shall be described as activity that is necessary for participation in the sport for which the equipment is designed. Malicious or deliberate damage caused by vandalism is not covered under First Team's Limited Warranty.

Superior Warranty -

Covers any damage or failure caused by any type of soccer activity, contact with the unit or associated use of the product. "Associated use" of the product includes but is not limited to transport of portable goals.

Any normal wear and tear caused by weathering, or UV exposure is not covered under any First Team warranty. All painted items carry a one year limited warranty on coating. All soccer nets carry a 1-Year Limited Warranty.

Some soccer products carry a warranty valid only when used in a residential setting. "Residential" is defined as a "single family dwelling." Products covered by this warranty stipulation are indicated in First Team's product literature with a  symbol next to the warranty. Under no circumstances shall any soccer product carrying a strictly residential warranty be covered for non-residential use.



VOLLEYBALL EQUIPMENT WARRANTY INFORMATION:

All First Team volleyball products are warranted against manufacturers defects at delivery. Additionally, most products are warranted to the original retail customer for a given period of time as stated in the literature. Below is an explanation of First Team's warranty levels for volleyball products.

Limited Warranty -

Covers any damage or failure that occurs during the course of "normal or intended use" of the product. Normal or intended use of the product shall be described as activity that is necessary for participation in the sport for which the equipment is designed. Malicious or deliberate damage caused by vandalism is not covered under First Team's Limited Warranty.

Superior Warranty -

Covers any damage or failure caused by any type of volleyball activity, contact with the unit or associated use of the product. "Associated use" of the product includes but is not limited to setup and teardown of volleyball systems.

Any normal wear and tear caused by weathering, or UV exposure is not covered under any First Team warranty. All painted items carry a one year limited warranty on coating. All volleyball nets carry a 2-Year Limited Warranty.

Some volleyball products carry a warranty valid only when used in a residential setting. "Residential" is defined as a "single family dwelling." Products covered by this warranty stipulation are indicated in First Team's product literature with a  symbol next to the warranty. Under no circumstances shall any volleyball product carrying a strictly residential warranty be covered for non-residential use.

First Team Sports, Inc.
902 Corey Rd.
Hutchinson, KS 67501

Sales: 800-649-3688
Customer Service: 888-884-6677
Fax: 620-663-6055

Website: www.firstteaminc.com
e-mail: firstteam@firstteaminc.com

www.firstteaminc.com

First Team, Inc. • Hutchinson, Kansas • Toll-Free 1-800-649-3688

91

First Team



902 Corey Rd.

Hutchinson, KS 67501

Sales: 800.649.3688

Customer Service: 888.884.6677

Fax: 620.663.6055

Website: www.firstteaminc.com

E-mail: firstteam@firstteaminc.com



SOLD EXCLUSIVELY THROUGH AUTHORIZED FIRST TEAM DEALERS