



# LITCHFIELD

Landscape  
elements™



Shelters Benches Gazebos Planters Kiosks & Message Centers Dugouts Grills  
Pergolas Bike Racks Performance Shelters Receptacles Steel Entry Gates  
Fabric Shade Structures Park Tables Theme Shelters Bollards Mini Shelters

14th Edition Catalog

Who would've imagined it? In 1973, a tiny woodworking company manufacturing wood picnic tables, benches and mini-shelters opened its doors in Litchfield, Michigan.

Accepting design challenges from Landscape Architects, Freelance Designers, and basically anyone who had enough initiative to sketch an idea down on a napkin has been our formula for growth.

Today, due to years of hard work, loyal dedicated employees & sales representatives, combined with an unwavering mission for success, Litchfield Landscape Elements has transformed into the park furnishing industry leader you'll marvel over in these pages.

Craig T. Saylor  
President

**Litchfield Landscape Elements  
is "America's #1 Choice"  
for shelters, pergolas, gazebos  
and architectural site furnishings!**

Our Steel Frame Series of shelters assemble easily with bolted, tubular steel construction leaving no areas for bird nesting. Select from our Pittsburgh All-Steel models with 24 gauge Pittsburgh Multi-Rib metal roofing for the greatest in strength and durability. Or choose from our Steel Beam Series which utilizes 29 gauge Litch-Top Max-Rib metal roofing over 2"X6" Southern Yellow Pine Tongue & Groove roof decking. Standing Seam metal roofing is also available at an additional charge.

Looking for a classic wood shelter? Litchfield offers the Laminated Series shelters which come in a variety of shapes, sizes and styles, and our Rustic Series shelters are an economical shade solution for coverage at a lesser cost.

Litchfield's gazebos are available in all the same materials listed above for shelters. From traditional to contemporary, there is a Litchfield Gazebo to meet your needs.

A complete line of site furnishings, including park tables, benches, litter receptacles, planters and more, allows you complete design flexibility in one source.



# TABLE OF CONTENTS

## 4 Pittsburgh & Steel Beam Shelters

Series 8100 Squares  
 Series 8000 Hexagonals  
 Series 8500 Octagonals  
 Series 8300 Gable Ends  
 Series 8200 Hip Ends  
 Duo-Top & Tri-Top Options  
 Series 2200 Classic Eights  
 Series 9000 All-Star Sports Shelters  
 Downtown Series Bus Stop Shelters  
 Litchfield Mini-Shelters

## 22 Gazebos

Series 7300 Stafford  
 Series 2900 Pagoda  
 Series 7800 Kingsford  
 Series 7500 Colonial  
 Series 7000 Deerfield  
 Series 1900 Brentwood  
 Series 2700 Resorter  
 Series 2800 New Englander

## 26 Litchfield Custom Designs

## 30 Litchfield Original Designs

## 31 Theme Shelter Designs

Vintage School Shelter  
 Barn-Style Shelter  
 Steamboat Shelter

## 32 Maestro Series Performance Shelters

Laminated Waved Beam  
 Summit Series  
 Cambria Series  
 Laminated Rainbow Arch  
 Monterey Series

## 34 Garden Gallery Pergolas

Series 9710 Raritan Bay  
 Series 9780 Boulevard  
 Series 9760 Arborview  
 Series 9750 Centennial Series  
 Series 9730 Senn Park  
 Series 9770 Town Square  
 Series 9720 Raritan Bay Duo-Top  
 Series 9740 Riverwalk

## 38 Fabri-Cover Shade Structures

## 40 Laminated Shelters

Series 1300 Laminated Hexagonals  
 Series 7900 Laminated Squares  
 Series 7200 Laminated "Stretched" Hex  
 Series 1600 Laminated Octagonals

## 41 Laminated Curved Beam Rectangulars

Series 1700 Curved Beam  
 Gable End & Dutch Hip

## 42 Laminated Solid Arch Series

Series 2000 Rectangular Solid Arch  
 Series 2000 Solid Arch Dutch Hip  
 Series 7100 Rectangular Solid Arch Hip  
 Series 1800 Laminated Solid Arch Hexes  
 Series 2300 Laminated Solid Arch Squares

## 43 Laminated Rainbow Arch Series

Series 2600 Rainbow Arch Rectangular  
 Series 2100 Rainbow Arch Hexagonal  
 Series 6800 Rainbow Arch Octagonal

## 44 Rustic Series Shelters

Series 1400 Woodland Gable  
 Series 2400 Woodland Dutch Hip

## Rustic Series Shelters (continued)

Series 1500 Timbercraft Gable  
 Series 2500 Timbercraft Dutch Hip  
 Series 1000 Wood Mini-Shelters  
 Series 1200 All-Weather Shelters  
 Series 1100 Barbeque Shelters

## 46 Centurion Steel Entry Gates

## 47 Kiosks & Message Centers

Series 7700 Kiosk  
 Model 1020 Two-Post Message Center  
 Model 7751 Four-Post Message Center  
 Model 9030 Three-Post Message Center

## 48 The Main Street Collection

## 49 Infinity Series All-Steel Benches

Model 3540 All-Steel Circular Bench  
 Model 3550 All-Steel Curved Backless Bench

## 50 Classic Benches

Series 3120 Grand Central  
 Series 3150 World's Fair  
 Series 3110 Bostonian  
 Series 3100 Liberty

## 51 Contour Benches

18-Slat, 13-Slat, 8-Slat  
 Wall Mount  
 Single Seat  
 Single Post

## 52 Wood Benches

Series 3300 Victory  
 Series 3200 Landscape  
 Series 3800 Dearborn  
 Series 3350 Burlington

## Wood Benches (continued)

Series 6600 Hoop  
 Series 3700 Hex Mall  
 Series 3400 Low Rider & Players  
 Series 3900 Deluxe & Rustic  
 Series 5100 Regular Mall & Square Mall  
 Series 5100 90 Mall & Straight Box Mall

## 54 Park Tables

Series 4300 American  
 Series 4800 Dearborn  
 Series 4200 Rustic Saddle Seat  
 Series 9500 Rustic Park  
 Series 4000 All-Wood Deluxe  
 Series 4100 Traditional  
 Series 4400 Mountaineer  
 Model 4445 Little Seats

## 56 Wood Litter Receptacles

Series 5200 Mall  
 Series 5300 Square  
 Series 5400 Round  
 Series 5500 Standard  
 Series 5600 Swing  
 Series 5700 Heavy  
 Series 5800 40-Slat

## 57 Earthcare Series Recycled Furnishings

## 58 Survivor Series Furnishings

## 72 Accessories

## 73 Product Information

Shelter Options & Accessories  
 Woods, Wood Finishes & Optional Steel Frame Finishes  
 Litch-Kicker Steel Frame Finish Colors & Specifications  
 Pittsburgh & Litch-Top Metal Roof Colors  
 Warranty & Terms





Model 8120 Custom 20' Pittsburgh Square Shelter with optional standing seam metal roof, ornamental laser-cut lattice, custom Litch-Kicker White frame finish, and custom overhang soffit provided locally by others

## STEEL FRAME SQUARES

### Standard Sizes:

12', 16', 20', 24', 26', 32', 40'

### Roof Pitches:

4:12 (Standard)

6:12 & 8:12 (optional)

### Roofing Options:

24 gauge Pittsburgh  
All-Steel pre-cut metal  
roof panels

29 gauge Litch-Top  
pre-cut metal roof  
panels over 2"X6"  
Southern Yellow  
Pine Roof Decking

Standing Seam Metal  
Roofing Upgrade

Fiberglass Shingles

Cedar Shingles

For shelter options & accessories, such as ornamental fretwork and handrails, column options and cupolas, see pages 73 & 74. Duo-Top and Tri-Top roof systems are also available. See page 14. Electrical access holes can be added at an upcharge.

***"Custom Design is Affordable and makes a Great Statement!"***

***Custom Designs, Sizes and Colors are always available!***

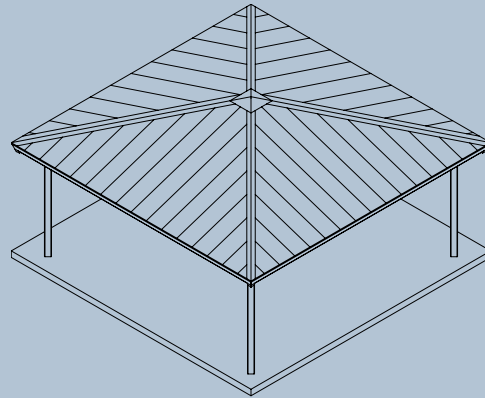

Model 8132P 32' Pittsburgh Square



Model 8116P Pittsburgh Square  
with cupola & weathervane



Model 8126DP Custom 26' Pittsburgh Square Duo-Top with handrails

(800) 542-5282

## STEEL FRAME HEXAGONALS



Model 8028DP 28' Pittsburgh Hexagonal Duo-Top with custom Litch-Kicker White framework and a cupola



Model 8024P 24' Pittsburgh Hexagonal with 24 gauge pre-cut metal roof panels

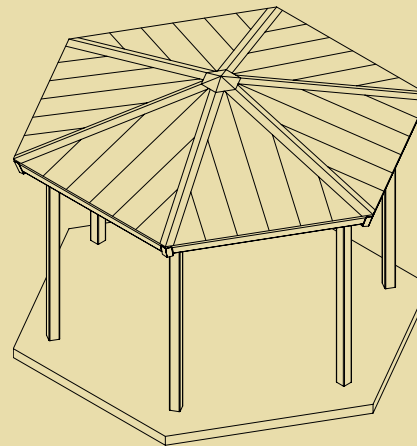

Model 8032P Custom 32' Pittsburgh Hexagonal with 24 gauge pre-cut metal roof, laser-cut lattice & handrails and a cupola

**Standard Sizes:**  
16', 20', 24', 28', 32', 40', 50'  
(roof-line dimensions)

**Roof Pitches:**  
4:12 (Standard)  
6:12 & 8:12 (optional)

**Roofing Options:**  
24 gauge Pittsburgh  
All-Steel pre-cut metal  
roof panels

29 gauge Litch-Top  
pre-cut metal roof  
panels over 2"X6"  
Southern Yellow  
Pine Roof Decking

Standing Seam Metal  
Roofing Upgrade

Fiberglass Shingles

Cedar Shingles

For shelter options & accessories, such as ornamental fretwork and handrails, column options and cupolas, see pages 73 & 74. Duo-Top and Tri-Top roof systems are also available. See page 14. Electrical access holes can be added at an upcharge.

***"Create a Custom Designed Litchfield Shelter and stand out from the crowd!"***

***Custom Designs, Sizes and Colors are always available!***



Model 8050S Custom 50' Steel Frame Hexagonal Duo-Top with custom laser-cut lattice & handrails, Cedar shakes (by others) over 2"X6" Southern Yellow Pine tongue & groove roof decking, round banded steel columns, cupola and weathervane



Model 8532SM Custom 32' Steel Frame Octagonal with cupola and 29 gauge Litch-Top pre-cut metal roof panels with 2"X6" Southern Yellow Pine roof decking. (column masonry by others)



## STEEL FRAME OCTAGONALS

### Standard Sizes:

16', 20', 24', 28', 32',  
40', 48', 54', 60'

### Roof Pitches:

4:12 (Standard)  
6:12 & 8:12 (optional)

### Roofing Options:

24 gauge Pittsburgh  
All-Steel pre-cut metal  
roof panels

29 gauge Litch-Top  
pre-cut metal roof  
panels over 2"X6"  
Southern Yellow  
Pine Roof Decking

Standing Seam Metal  
Roofing Upgrade

Fiberglass Shingles

Cedar Shingles

For shelter options & accessories, such as ornamental fretwork and handrails, column options and cupolas, see pages 73 & 74. Duo-Top and Tri-Top roof systems are also available. See page 14. Electrical access holes can be added at an upcharge.

***"Get Creative and  
Customize your Shelter!"***

***Custom Designs, Sizes and  
Colors are always available!***

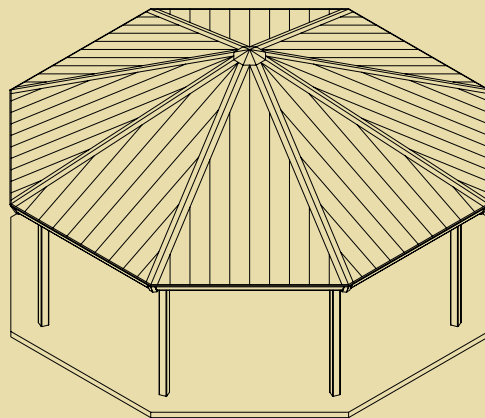

Model 8520P 20' Pittsburgh Octagonal



Model 8532DP 32' Pittsburgh Octagonal Duo-Top with laser-cut lattice & handrails, round banded steel columns and cupola



Model 8560DSM 60' Steel Frame Octagonal Duo-Top with cupola

(800) 542-5282

## STEEL FRAME GABLE END RECTANGULARS



Model 8340SF-2 Custom 40'X44' Steel Frame Gable End with 2X6 Southern Yellow Pine tongue & groove roof decking, round columns, fiberglass shingles and exposed rafter beams



Model 8360P-3 60'X64' Pittsburgh Gable End with custom 6:12 roof pitch

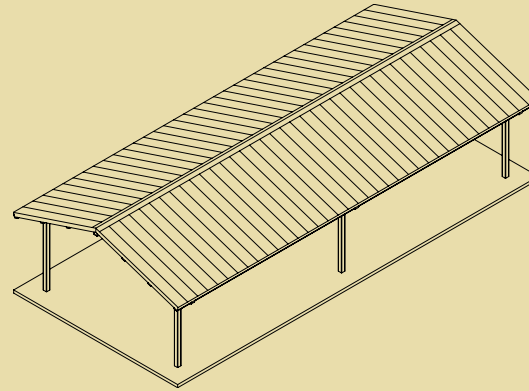

Model 8316P-1 16'X20' Custom Pittsburgh "Chalet-Style" Gable End

**Standard Widths:**  
16', 20', 24', 30', 40'

**Standard 20' Bay Lengths:**  
24', 44', 64', 84', 104'

**Roof Pitches:**  
4:12 (Standard)  
6:12 & 8:12 (optional)

**Roofing Options:**  
24 gauge Pittsburgh All-Steel pre-cut metal roof panels

29 gauge Litch-Top pre-cut metal roof panels over 2"X6" Southern Yellow Pine Roof Decking

Standing Seam Metal Roofing Upgrade

Fiberglass Shingles

Cedar Shingles

For shelter options & accessories, such as ornamental fretwork and handrails, column options and cupolas, see pages 73 & 74. Duo-Top and Tri-Top roof systems are also available. See page 14. Electrical access holes can be added at an upcharge.

**"As Always...  
Feel Free to Customize it!"**

**Custom Designs, Sizes and  
Colors are always available!**



Model 8340P-2 40'X44' Pittsburgh Gable End. In Foreground: Model 2916 Custom 16' Pagoda Gazebo with 2X6 Southern Yellow pine tongue & groove roof decking, curved laminated wood beams, custom color Litch-Kicker finished 5"X5" steel columns, and fiberglass shingles



## STEEL FRAME HIP END RECTANGULARS

### Standard Widths:

16', 20', 24', 30', 40'

### Standard 20' Bay Lengths:

24', 44', 64', 84', 104'

### Roof Pitches:

4:12 (Standard)

6:12 & 8:12 (optional)

### Roofing Options:

24 gauge Pittsburgh  
All-Steel pre-cut  
metal roof panels

29 gauge Litch-Top  
pre-cut metal roof  
panels over 2"X6"  
Southern Yellow  
Pine Roof Decking

Standing Seam Metal  
Roofing Upgrade

Fiberglass Shingles

Cedar Shingles

For shelter options & accessories, such as ornamental fretwork and handrails, column options and cupolas, see pages 73 & 74. Duo-Top and Tri-Top roof systems are also available. See page 14. Electrical access holes can be added at an upcharge.

**"Litchfield Custom Designs  
are a Sound Value!"**

**Custom Designs, Sizes and  
Colors are always available!**

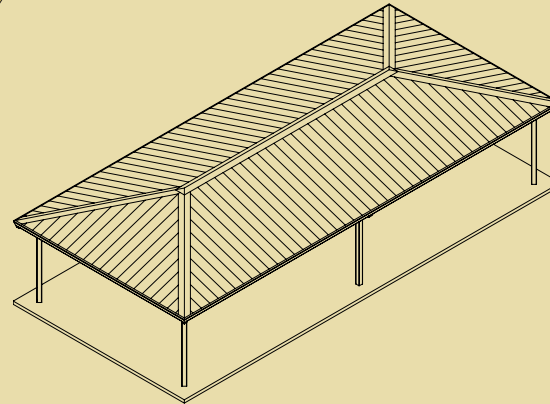

Model 8220SM-2  
Custom 20'X44' Steel Frame Hip End  
with Western Red Cedar roof decking  
and standing seam metal roofing.  
Stone column pedestals  
designed and built by others.



Model 8216P-1 16'X24' Pittsburgh Hip End  
with custom Litch-Kicker Finished Red Framework



Model 8225SM-2 Custom 25'X35' Steel Beam Hip End  
with 2"X6" Southern Yellow Pine tongue & groove roof decking  
and round banded steel columns with custom arrangement

(800) 542-5282

## DUO-TOP AND TRI-TOP OPTIONS



Model 8560DP Custom 60' Pittsburgh Octagonal Duo-Top with lattice, handrails and a cupola



Model 8520DSM Custom 20' Steel Beam Octagonal Duo-Top with lattice, handrails, T&G roof decking, custom white Litch-Kicker frame finish and a cupola



Model 8160DSM Custom 60'X60' Steel Beam Square Duo-Top with 29 gauge metal roofing over 2"X6" Southern Yellow Pine T&G roof decking. Masonry by others.



Model 8028DSM Custom 28' Steel Beam Hexagonal Duo-Top with 29 gauge metal roofing over 2"X6" Southern Yellow Pine T&G roof decking, lattice and a cupola



Model 8520DP  
20' Pittsburgh Octagonal Duo-Top with cupola

Litchfield standard shelters can be turned into eye-catching centerpieces for a park or landscape setting by adding a second or third tier. The 2-Tier & 3-Tier Option is available for most steel frame shelters. Triangles, Squares, Hexagonals, Octagonals, Gable & Hip End structures take on the appearance of a gazebo when a second or third tier is added. Two & Three tier shelters can be further upgraded with oversized columns, handrails, fretwork, and a cupola. See pages 73 & 74.



Model 8540TP 40' Pittsburgh Octagonal Tri-Top with lattice, handrails and a cupola

# CLASSIC EIGHTS



Model 2232 30' X 44' "Classic Eights" Gable End with fiberglass shingles

## "Classic Eights" Shelter Features:

- Widths: 16', 20', 30' and 40'
- Gabled Lengths: 20', 28', 36', 44', 52', 60' (+8' bays)
- Hipped Lengths: 32', 40', 48', 56', 64', 72' (+8 bays)
- Tubular Steel Frame with Tongue & Groove Roof Deck
- Pressure Treated Fascia
- Adobe Tan, Forest Green, Black or Brown Litch-Kicker Frame Finish

## "Classic Eights" Shelter Options:

- Powder Coated Frame Finish
- E-coated Frame Primer
- Cedar Tongue & Groove Roof Deck & Fascia
- Barbecue Roof Vent
- Fiberglass or Cedar Shingles
- Galvalume Pre-cut Metal Roof Panels
- Standing Seam Metal Roof Panels
- Steel Handrails & Custom Laser-cut Gable Ornaments



View of Model 2260 Custom 40'X60' Steel Beam "Classic Eights" Chalet's ornamental steel gable end detail (lighting by others).



Model 2260 Custom 40'X60' Steel Beam "Classic Eights" Chalet

As they say, "the Classics never go out of style". This statement certainly rings true with respect to Litchfield's line of "Classic Eights" shelters which combines the strength and durability of steel with the warmth of tongue and groove wood roof decking. The "Classic Eights" Gable End, Dutch-Hip and Chalet Style shelters also offer incredible versatility. Their classic 8' bay spacing between columns allows for lengths not found in our 20' bay shelters, without the need for intermediate purlins.



Model 2282 30'X56' "Classic Eights" Dutch Hip with cedar shingles



A shelter-length barbecue vent is also available for any size Litchfield "Classic Eights" shelter.

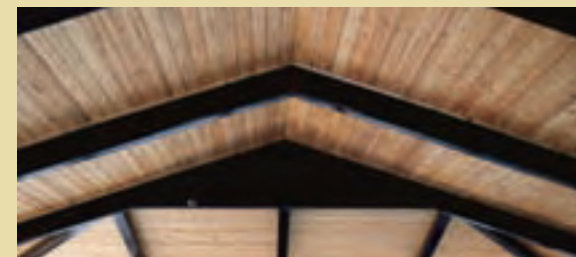

Model 2282 30'X56' "Classic Eights" Dutch Hip Ceiling





# ALL-STAR SPORTS SHELTERS

## Series 9070 All-Steel Dugouts

These All-Steel Dugouts are ideal for use at athletic fields, shuffleboard courts, bus stops or along walking paths as cover for park benches.



Model 9072 8'X28' Center Post All-Steel Dugout



Model 9071 8' X 28' All-Steel cantilevered Dugout shown with optional Survivor Series Benches

## Model 9050 Extreme Sports Covers

*Now moving outside our traditional size parameters...*

Designed to allow outdoor sporting events to continue in the rain or elevated temperatures, the Extreme Shelter is a modified Steel Frame Gable-End Rectangular with elevated roof pitch and raised columns to provide ample clearance for court games. These structures are available in Pittsburgh and Steel Beam models. Extreme Sports Covers can be provided at nearly any imaginable size.



Model 9050 50'X70' Extreme Sports Cover



## Model 9051 All-Steel Range Shelters

These sturdy shelters are designed to allow golfers to practice their swings, rain or shine. They also have several other practical uses including bleacher covers, farmer's markets or ball field dugouts. Current sizes available are 12'-6" X 27' and 20' X 60' (shown), but we can custom design one to meet your needs. Gutters are also available.



Model 9057 20' X 60' All-Steel Range Shelter

## Model 9079 Press Box Video Booth Cover

This Custom 8'X36' Pittsburgh Hip-End Rectangular shelter is used as a cover for the video platform at a high school athletic stadium. It features powder coated tubular steel frame, pre-cut painted galvalume metal roof panels, and powder coated steel railings. Litchfield engineers worked with facility managers to fit the structure to their existing announcer's booth, and to verify structural integrity.



(800) 542-5282



## DOWNTOWN SERIES BUS STOP SHELTERS

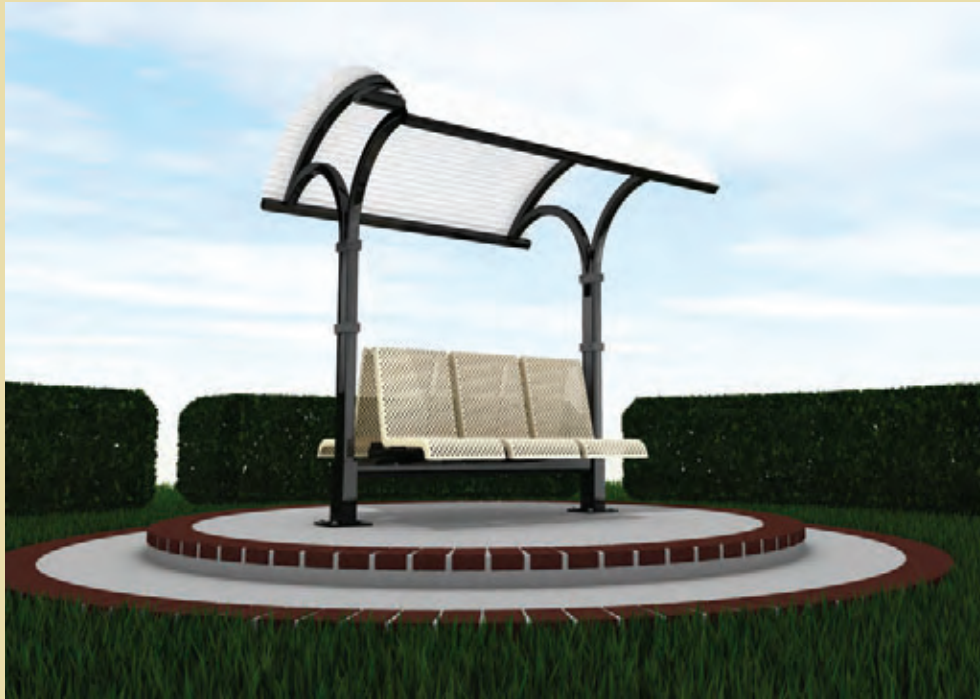

### Model 8210 Village Square Bus Stop Shelter

Enjoy the tremendous protection from the elements provided by the All-Steel Hip End Bus Shelter. This 4-column design allows for the addition of optional Lexan panels which act as wind-screens to block even more wind and rain. Perfa-Lite perforated metal panels can also be selected as a wind-screen option. Other options include: single or double display cases, and Litch-Top pre-cut metal roof with 2"X6" Southern Yellow Pine T&G roof decking.

### Model 8908 Eurbana Bus Stop Shelter

The Eurbana Transit Shelter provides roomy seating for six individuals in tremendous style beneath a curved corrugated steel roof with elegant curved steel supports. Options include mesh screen divider, single or double display cases, or a picnic table.

Model 8910P 8'X8' All-Steel Eurbana Bus Stop Shelter with (6) seats and double sided display case



Model #8210P-1 Custom 10'X6' Pittsburgh All-Steel Hip End Bus Shelter with 4-column design and optional Lexan wind-screens on 3 sides. Shown with 6' Survivor Bench with back.

## **DOWNTOWN SERIES BUS STOP SHELTERS**

### **Model 8310 Community Bus Stop Shelter**

Model 8310P-1 Custom 10' X 10' Pittsburgh All-Steel Gable End Bus Shelter shown with 4-column design, Lexan wind-screen panels on 3 sides and 6' Survivor Series Bench with back. Custom sizes always available. Other options include: mesh screen divider, Perfa-Lite perforated metal wind-screen panels, single or double display cases, and Litch-Top pre-cut metal roof with 2"X6" Southern Yellow Pine T&G roof decking.



### **Model 8205 Plaza Bus Stop Shelter**

Model 8205P-1 Custom 5' X 10' Pittsburgh All-Steel Arched Bus Stop Shelter with 4 column design, 2 Lexan panels on 5' ends, and 1 Lexan panel and a Survivor Bench on the 10' side. Custom sizes always available. Other options include: mesh screen divider, Perfa-Lite perforated metal wind-screen panels, single or double display cases, and Litch-Top pre-cut metal roof with 2"X6" Southern Yellow Pine T&G roof decking.

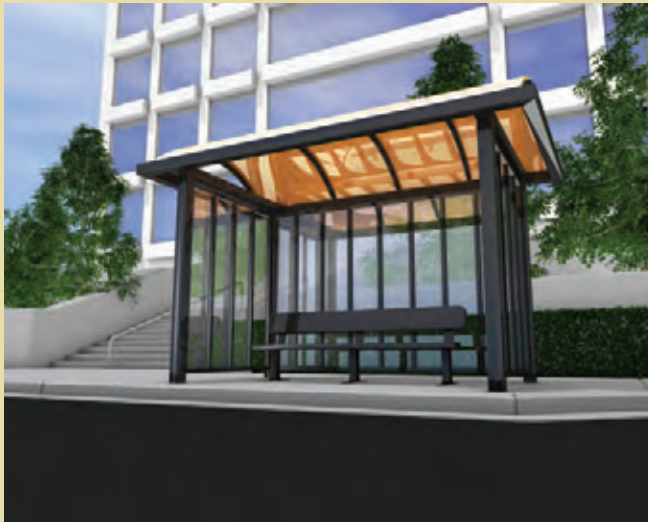

### **Model 7218 Restoration Style Bus Stop Shelter**

The Restoration-Style Pittsburgh All-Steel Hexagonal Duo-Top Bus Shelter with ornamental custom laser-cut bench and handrail supports, lattice and banded decorative columns will beautifully adorn any streetscape with its historical architectural appeal. Custom sizes always available. Other options include: mesh screen divider, single or double display cases, Litch-Top pre-cut metal roof with 2"X6" Southern Yellow Pine T&G roof decking, and a picnic table.



Model 7218P Custom 4' X 18' Pittsburgh All-Steel Restoration-Style Duo-Top Bus Stop Shelter with custom ornamental laser-cut lattice, benches & handrail supports, and banded columns with decorative details



# LITCHFIELD MINI-SHELTERS

Our Mini-Shelters are a greatly cost effective way to provide cover with tremendous versatility. Pair either the Pittsburgh All-Steel or the Steel Beam models with a bench, table, display board or bike rack, and you can provide multiple services in a small area.

The original gable models are available in sizes of 8', 10' and 12'. The 2-Post Hipped Mini is available as a 12' square.



Model 8401P 8'X8' Pittsburgh Mini-Shelter open



Model 2099S 10'X10' Steel Beam Mini-Shelter with Bike Rack, 2'X6" Southern Yellow Pine T&G roof decking and fiberglass shingles



Model 2080ADA 8'X8' Steel Beam Mini-Shelter with ADA bench in recycled plastic



Model 8450P 12'X12' Pittsburgh 2-Post Hipped Mini-Shelter



Model 2090S 8'X8' Steel Beam Mini-Shelter with Display Case (sign on top by others)



Model 8407P 10'X10' Pittsburgh Mini-Shelter with Survivor Table



## Series 8000 Pittsburgh All-Steel "Umbrella-Style" Mini

The All-Steel Single Post "Umbrella-Style" Shelter (hexagonal shown here) is the perfect shade structure to place along a hiking or jogging trail, a dog walking park or bus stop. Optional Infinity Series bench or picnic table available. Also available as an octagonal or square.

Right: Model 8008P All-Steel 8' "Umbrella-Style" Hexagonal Single Post Shelter

(800) 542-5282



# LITCHFIELD GAZEBOS



Model 8016SF Custom 16' Steel Frame Duo-Slope Hexagonal with custom ornate rainbow lattice, custom Litch-Kicker frame color, fiberglass shingles and a cupola (column masonry by others)



Model 7316P Custom 16' Pittsburgh Stafford Gazebo with ornate custom laser-cut lattice and cupola. Column masonry by others.



Model 2910 16' Pagoda Gazebo with handrails and fiberglass shingles. Wood stain applied locally by others.

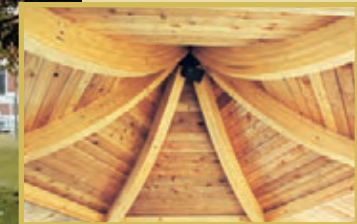

Above: Ceiling of a Pagoda Gazebo with Western Red Cedar roof decking. Additional cost for cedar construction.

## Series 7300 Stafford Gazebo

The dual-pitched roof of the Stafford Gazebo is a popular design specified by many designers wanting a traditional look. Both Pittsburgh and Steel Beam versions have a full line of accessories to make this gazebo as plain or ornate as you wish. The Stafford is available in sizes of 16', 20', 24', 28', 32', 40' and 50'. The options for steel beam models are fiberglass shingles and Pre-cut Galvalume or Standing Seam metal roofing.



Model 7316P Custom 16' Pittsburgh Stafford Gazebo with handrails and circle pattern lattice.

## Series 2900 Pagoda Gazebo

The gently curving laminated rafter beams sweep the roof of this gazebo to a gradual point, where it is capped in copper. The Pagoda Gazebo is available in sizes of 16', 20', 25', 30' and 35'. Columns are pressure-treated pine, and the roof deck is 2X6 Southern Yellow Pine T&G. Options include laminated wood columns, steel columns, cedar roof decking, wood or steel handrails and overhead lattice, fiberglass shingles and benches.



A cluster of various sized Pagoda Gazebos used as an outdoor dining area.

# LITCHFIELD GAZEBOS



Model 7828P Custom 28' Pittsburgh Kingsford Gazebo with masonry columns by others



Model 7814SM 14' Steel Beam Kingsford Gazebo with overhead lattice, handrails, functional cupola and 2"X6" Southern Yellow Pine T&G roof decking over galvalume metal roofing

## Series 7800 Kingsford Gazebo

The Kingsford Gazebo is available in both Pittsburgh All-Steel or Steel Beam models. This hexagonal gazebo with a 12:12 roof pitch comes in sizes of 14', 18', 24', 28', 32' and 40'. The functional open cupola is an integral part of the framework. Options include steel handrails & overhead lattice and benches. Roofing options for Steel Beam models are fiberglass shingles, Pre-cut Galvalume or Standing Seam metal roofing (additional cost for standing seam).



Model 7520 20' Custom Colonial Gazebo with custom white Litch-Kicker steel columns, custom cedar railings & lattice, wind braces, and fiberglass shingles. White stain applied locally by others.

## Series 7500 Colonial Gazebo

A number of components on the Colonial Gazebo are pre-assembled for a more simplified installation. It is available in sizes 12', 16' and 20'. Options include: handrails and overhead lattice, wood deck with stairs, fiberglass or cedar shingles, Galvalume or Standing Seam pre-cut metal roofing. The Colonial is also available in Treated Pine or All-Steel construction with surface mounted or direct bury columns.



Model 7516P 16' Custom Pittsburgh All-Steel Colonial Gazebo with overhead lattice, handrails and custom Copper Litch-Kicker frame finish

# LITCHFIELD GAZEBOS



Model 7025 25' Deerfield Gazebo with glue laminated stepped columns, 2"x6" Southern Yellow Pine T&G roof decking and cupola (roofing material by others)



Model 1904 18'-6" Brentwood Gazebo with steel columns and handrails, ornate cap, and 29 gauge Litch-Top pre-cut metal roofing over 2"x6" Southern Yellow Pine T&G roof decking

## Series 7000 Deerfield Gazebo

The hexagonal, two-tiered Deerfield Gazebo is available in sizes of 25', 30', 35', 40' and 45'. The stepped columns (also available in all-steel), rafter beams, headers and purlins are all glue-laminated Pine, and the roof deck is 2X6 Southern Yellow Pine T&G. The cupola is included. Options include: steel columns, wood or steel handrails and overhead lattice, vented cap, cedar T&G roof decking, fiberglass or cedar shingles, Litch-Top Pre-cut metal roofing, Standing Seam metal roofing.

Right: Model 7030 30' Deerfield Gazebo with cupola. Custom roof materials by others.



Model 7035 35' Deerfield Gazebo with cupola and fiberglass shingles (White stain applied locally by others)



## Series 1900 Brentwood Gazebo

Originally designed in all wood construction this classic hexagonal gazebo receives a welcomed update with its Pittsburgh All-Steel and Steel Beam versions. Options include: steel or laminated wood columns, wood or steel handrails and overhead lattice, vented cap, cedar T&G roof decking, fiberglass or cedar shingles, Litch-Top Pre-cut metal roofing, Standing Seam metal roofing, a golf course enclosure, and a unique spire roof.



Model 1903 18'-6" Brentwood Gazebo with handrails



# LITCHFIELD GAZEBOS



Model 2720 Resorter Gazebo with cedar shingles, handrails and custom peak finial (restroom enclosure custom-built in the field by others)

## Series 2700 Resorter Gazebo

Available in 16' and 20' sizes. This octagonal all-wood gazebo has pressure treated Pine columns, dimensional lumber framing and 2X6 Southern Yellow Pine T&G roof decking. The standard Resorter Gazebo has ornate rafter ends and a decorative finial at the peak (as shown at right).

Optional features include: all-cedar construction, a cupola, floor decking with steps, laminated wood columns, steel columns, wood or steel handrails and overhead lattice, fiberglass or cedar shingles, Litch-Top Pre-cut metal roofing, and Standing Seam metal roofing.



Model 2850 25' New Englander Gazebo with cedar shingles, handrails, overhead lattice and ornamental wind braces. White stain applied locally by others.



Model 2710 Resorter Gazebo with handrails, fiberglass shingles and a cupola. Wood stain applied locally by others.

## Series 2800 New Englander Gazebo

The dual pitched roof of the octagonal New Englander adds a bit of interest to this attractive gazebo which is available in 15', 20' and 25' sizes. Columns are pressure-treated Pine. Other frame components are standard dimensional lumber. The roof deck is 2X6 Southern Yellow Pine T&G, and the fascia board is pressure-treated Pine. Options include: all-cedar construction, overhead lattice and handrails, ornamental wind braces, floor decking with steps, benches, laminated straight or stepped columns, fiberglass or cedar shingles, Litch-Top Pre-cut metal roofing, and Standing Seam metal roofing.



Model 2825 15' New Englander Gazebo with handrails, overhead lattice, ornamental wind braces and 29 gauge Litch-Top Pre-cut metal roofing.

## LITCHFIELD CUSTOM DESIGNS

Model 8182 Custom Pittsburgh Performance Shelter



Model 8197DSM-G Custom Steel Beam Picnic Pavilion featuring (2) 31' and (2) 39' custom Square Duo-Top shelters with custom round banded steel columns, ornate laser-cut flags, and a centrally positioned custom Garden Gallery Pergola



**Litch.eld's Laser-Cutting Capabilities let you Add a Little "Bling-Bling" to your Shelter for a One-of-a-Kind Design!**

Any design that can be illustrated in CAD can be cut in plate steel. This feature enables you to customize any shelter or site furnishing to fit a theme, for example, for your park, city, amusement park, playground, schoolyard, zoo, or day-care center.



Model 8618 Custom 18' Pittsburgh Cabana Square adjoined to (2) 7'X9' Arcata Rectangular Gables both featuring banded steel columns, inset metal roofing and laser-cut ornamentation. Shown with custom Main Street laser-cut litter receptacles and custom Main Street Grand Central benches (both with custom colors).



Model 8316P-GT Custom 16'X32'/16'X10' Pittsburgh Gable End T-shelter with 8:12 roof pitch, laser-cut sunburst gable enclosure, white Litch-Kicker frame finish and cupola

# LITCHFIELD CUSTOM DESIGNS

## Series 9300 Sky Series Solar Shelters

featuring Perfa-Lite™ Perforated Metal Roofing

The All-Steel Sky Series Solar Shelter utilizes a slanted ridge beam, curved perimeter beams and the all-new "Litchfield Exclusive" Perfa-Lite perforated metal roofing to simulate the aesthetic appeal and light dispersing function of fabric shade structures. This is a wonderful alternative to fabric structures when vandalism or extreme climates become an issue. The All-Steel construction of the Sky Series will guarantee many years of maintenance free service while providing an abundant amount of



Model 9313-SK Custom 13'X18' Pittsburgh All-Steel Sky Series Solar Shelter featuring Perfa-Lite perforated metal roofing

light into the shelter for a lighter, brighter outdoor experience. Outdoor safety is another important issue. Perfa-Lite blocks up to 44% of harmful UV rays consistently throughout the life of the shelter.

The Sky Series is available in custom sizes, designs and colors. A Duo-Top version is also available (see drawing below).



View of Perfa-Lite perforated metal roofing

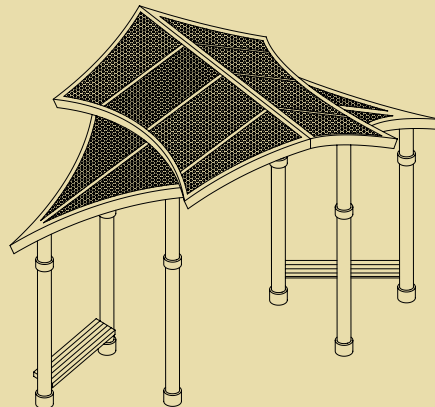

Model 9313-SKD Custom 13'X18' Pittsburgh All-Steel Sky Series Duo-Top Solar shelter featuring Perfa-Lite perforated metal roofing, custom round banded steel columns and straight backless all-steel attached benches

## Custom Park Entrance Sign with Gable End Entry Archway Bus Shelters



(1) Model 9924P Custom 24' Pittsburgh Park Entrance Sign featuring custom laser-cutting and decorative baseball and soccer ball connected to (2) Model 8308P Custom 8'X20' Pittsburgh Gable End Entry Archway shelters featuring a custom 12:12 roof pitch and standing seam metal roofing.

## Custom Gable End Duo-Top



Model 8340DP Custom 40'X48' Pittsburgh Gable End Duo-Top Shelter featuring decorative bracing on top tier and standing seam metal roof. Column masonry by others.

(800) 542-5282

Custom Peaked Square  
with attached Angled "Side-Wings"

***Bold and Innovative Landscape Elements***



***Designs that are Uniquely Litchfield!***

The unique angularity of this structure gives it a very modern, "stealthy" appearance which complements much of the architecture in our modern cities. The Model 8176P Custom 32'X32' Peaked Square Shelter is integrated with two Model 8167P Custom 18'X35' Angled "Side-Wing" Shelters. Features include Pittsburgh All-Steel 24 gauge metal roof and custom round banded steel columns. Column masonry by others.



## LITCHFIELD CUSTOM DESIGNS

### Center Post Gables

The Model 8336P Custom 36'X151' Pittsburgh Gable End Center Post shelter provides tremendous coverage for vehicles, boats, farm equipment and more with it's massive size and efficient center post design. The Gable end Center Post shelter features a 24 gauge Pittsburgh All-Steel metal roof and custom 12" square banded steel columns.

Column masonry by others.



***This space-saving Center Post Design is engineered with massive custom 12" square columns making the Gable End Center Post Shelter the perfect choice for use as a parking structure and more!***



**Litchfield's Center Post Gables provide great cover for a wide range of facilities such as:**

- Hotels & resorts
- Marinas
- Military bases
- Shopping centers/malls
- Amusement parks
- Corporate/Industrial parking lots
- Apartment complexes
- Open air/Farmer's markets
- Sports facilities
- Tourist attractions
- Campgrounds
- Farms

# LITCHFIELD ORIGINAL DESIGNS

## Steel Framed Triangle



Model 8800P Custom 18' Pittsburgh Triangular Duo-Top shelter with western-style lattice & handrails, and cupola

The Pittsburgh Triangular Duo-Top Shelter has pre-cut 24 gauge painted galvalume roof panels, western pattern lattice and handrails, and a cupola.

As with other Litchfield steel framed shelters, the Triangle is available in single, duo-top and tri-top roof configurations, in both Pittsburgh All-Steel, and Steel Beam models ranging from 12' to 28'.

## Peaked Square Shelter

Not your typical square shelter. The Peaked Square utilizes a slanted roof design supported by a ridge beam and four columns of two different lengths which helps create the unique angular look of these shelters. These interesting and fun "Peaked" Square shelters are available in Pittsburgh All-Steel and Steel Beam models with 2"X6" Southern Yellow Pine tongue and groove roof decking beneath metal panels which, in this instance, is standing seam metal roofing.



Left: (2) Model 8112SM Custom 12' Steel Beam Peaked Square shelters with 8" square columns and standing seam metal roof.



Model 8124SM Custom 24' Steel Beam Peaked Square shelter with 8" square columns and standing seam metal roof. Masonry by others.

## Standard Shelter Designs as Garden Gallery Pergolas



Model 9920 Custom 20' Pittsburgh Garden Gallery Square Shelter with laser-cut circle pattern lattice



Close-up view circle pattern lattice and the pergola's steel slats

Each of Litchfield's standard shelters can be used as the basis for creating a spectacular Garden Gallery Pergola. Simply select a standard shelter shape (square, hexagonal, octagonal, gable end or hip end) and we'll create a Garden Gallery Pergola using individual steel slats connected to the steel frame with stainless steel fasteners.

Choose from our many standard shelters in the Litchfield line, or if you're looking for a pergola with soft curves and a different architectural aesthetic select from our wide variety of Garden Gallery Pergolas starting on page 35.

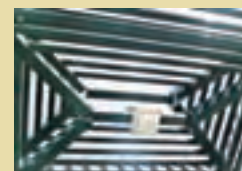

Model 8216P Custom 16'X24' Pittsburgh Hip End Duo-Top Garden Gallery Pergola with laser-cut circle pattern lattice (column masonry by others)

## THEME SHELTER DESIGNS

### Variations on a Theme.



### Litchfield takes Custom Design to Another Level!

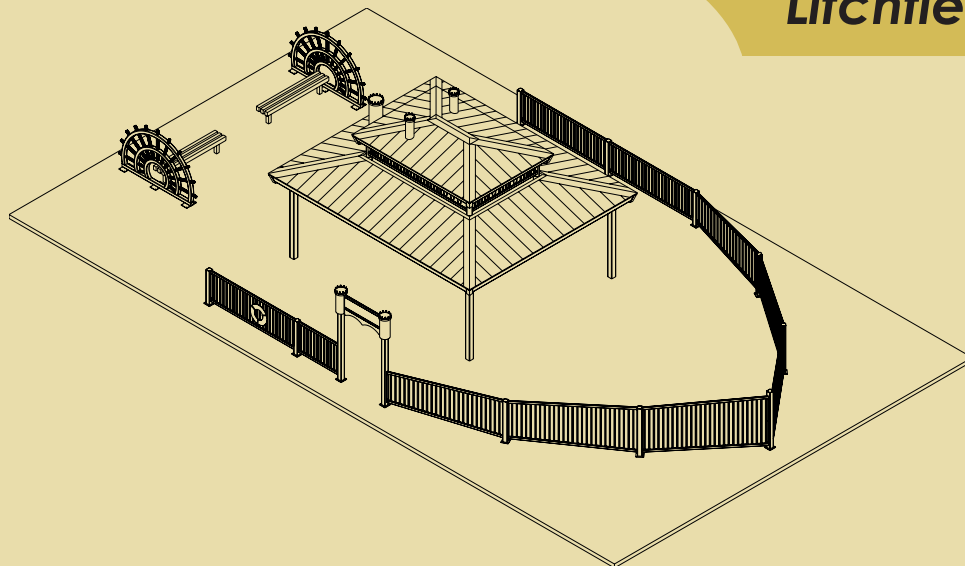

With Litchfield design and engineering you can let your imagination run wild to create a theme shelter to perfectly complement the other elements in your amusement park, water park, playground, or sports complex, just to name a few. Take your park or landscape to another level and allow us to design a custom Litchfield Theme Shelter for you!

Top Left: Model Custom 8312P-1 12'X20' Pittsburgh All-Steel Gable End School Shelter with a steeple including a laser-cut bell and gable enclosures with ornamental laser-cutting.

Top Right: Model 8316SM Custom 16'X25' Steel Frame Glendale Farms Gable End Barn-Style shelter featuring a duo-slope roof, gable enclosures with laser-cut barn door accents, custom white Litch-Kicker frame finish and a cupola. Designed to match a barnyard themed playground (partially shown on right side of photo) located in Yorkville, Illinois.

Bottom Left: Model 8220DP-1 Custom 20'X24' Pittsburgh All-Steel Hip End Duo-Top Steamboat Shelter with custom laser-cut lattice, handrails with entry archway & laser-cut life preservers, tubular steel smokestacks with laser-cut accents, and all-steel in-ground benches with decorative paddle wheel ornamentation.

(800) 542-5282

# MAESTRO SERIES PERFORMANCE SHELTERS



Model 9008 40' X 20' Laminated Waved Beam Performance shelter with Quad-Steel columns

## Laminated Waved Beam Performance Shelter

The Waved Beam Performance shelter is available in standard sizes of 40' X 20', 40' X 30' and 40' X 40' (custom sizes are always available). Glue-laminated waved beams free-span from side to side, supported by steel columns. The roof deck is 2" X 6" southern yellow pine tongue & groove. Options include: cedar tongue & groove roof deck, oversized steel columns or Litchfield's own "Quad-Steel" columns (see top photo), and fiberglass shingles.



Model 9012 40' X 30' Waved Beam Performance shelter (masonry by others)



Model 9008 40' X 20' Waved Beam Performance shelter (masonry by others)



Model 9836P  
Custom 36' Pittsburgh Summit Series Performance Shelter

## Summit Series Performance Shelter

Enjoy many years of great concert performances with the durable All-Steel Summit Series Performance Shelter which features an extended half-octagon design which features a voluminous 36' of overhead coverage accented by a peaked roof with exposed rafter beams creating a unique architectural detail.

## Cambria Series Performance Shelter

This custom designed concert shelter comprises an Octagonal Steel Beam shelter with a Gable Opening on one side. This design with the gable opening creates a very dramatic effect with a stunning archway facing the audience. The beautiful western red cedar roof decking (also available in southern yellow pine) adds another eye-pleasing element to this gorgeous performance shelter.

This structure features a bolted tubular steel frame, 2" X 6" western red cedar tongue & groove roof deck, and standing seam metal roofing.



Model 7400SM 25' X 30' Cambria Series Octagonal Steel Beam Performance shelter featuring a gable opening, steel handrails, ornamental lattice, Western Red Cedar roof decking and standing seam metal roof



# MAESTRO SERIES PERFORMANCE SHELTERS

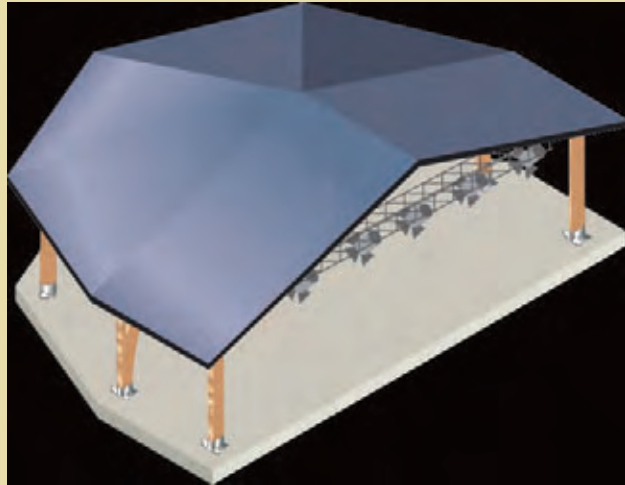

## Laminated Rainbow Arch Performance Shelter

The Laminated Rainbow Arch design combines portions of our Octagonal Laminated Rainbow Arch and Laminated Curved Beam shelters to create a stage cover that is deep and wide. Side-to-side span under roof is 36'. Columns, beams and arches are all glue-laminated southern yellow pine. The roof deck is 2" X 6" southern yellow pine tongue & groove. Options include: cedar tongue & groove roof deck, handrails and overhead lattice, fiberglass or cedar shingles, Litch-Top pre-cut metal roofing or standing seam metal roofing.

Steel Beam and Pittsburgh Steel Frame versions are available.



Model 9037 Laminated Rainbow Arch Performance shelter with 2"x6" Southern Yellow Pine T&G roof decking and fiberglass shingles



## Monterey Series Performance Shelter featuring Perfa-Lite™

The newest addition to the Maestro Series line-up is the Monterey Series Performance shelter. The Model 9916 Monterey Series is a custom 36' 10-sided All-Steel performance shelter with a "Fan-Style Roof" which in this instance (see photos) utilizes a brand new metal roofing alternative called Perfa-Lite™ which has been created by Litchfield.

Built to last with All-Steel construction. The Perfa-Lite™ roof allows light to shine through while still providing tremendous protection from the sun's harmful rays! See page 74 for more details about Perfa-Lite™.



## GARDEN GALLERY PERGOLAS



Model 9710 14' X 60 All-Steel Raritan Bay Curved Beam Pergola with optional Round Banded Steel Columns (column masonry by others)

### Raritan Bay Pergola

The Raritan Bay Pergolas soft curves create a striking architectural statement as a memorial or the focal point of a garden or a landscape setting. The Raritan Bay's bolt together tubular steel construction ensures ease of installation and many years of maintenance free enjoyment. Also available in a duo-top model (shown at top right).



Model 9710 Custom 10'X34' Pittsburgh Raritan Bay Pergola with 8" round banded columns



Model 9780 8' X 29'-6" All-Steel Boulevard Straight Beam Pergola with curved wind braces and standard Quad-Steel Columns

### Boulevard Pergola

Quad-Steel columns and canti-levered design make the Boulevard a stunningly elegant pergola option. Add attached benches and a Pittsburgh or Litch-Top pre-cut metal roof, or Perfa-Lite perforated metal roof and the Boulevard Pergola makes an attractive and functional bus stop shelter.



Right: Isometric view of a standard All-Steel Quad Column



Model 9720 8' X 120° All-Steel Raritan Bay Curved Beam Duo-Top Pergola



Model 9710 Custom 12'-6"X75° Pittsburgh Raritan Bay Pergola with round banded columns

**Curved Beam Pergolas are based on 30° increments**

Pergola Options:

- Square, Rectangular or Round Radial Beams
- Square, Rectangular, Round, or standard or premium Quad-Steel columns (straight or stepped)
- Perfa-Lite Perforated Metal Roofing (for more details see p. 74)
- Roof Pitches: 4:12, 6:12, 8:12 or flat



Close-up view of the Boulevard Pergolas cantilevered design

## GARDEN GALLERY PERGOLAS



Model 9760 Custom 7'-3"X134' All-Steel Curved Beam Arborview Pergola with 3" round radial beams (paint finish by others)

**Curved Beam Pergolas  
are based on 30° increments**

### Pergola Options:

- Square, Rectangular or Round Radial Beams
- Square, Rectangular, Round or Quad-Steel Columns (Straight or Stepped)
- Perfa-Lite Perforated Metal Roofing (for more details see p. 74)
- Roof Pitches: 4:12, 6:12, 8:12 or flat



Model 9750 Custom 50' X 99'  
All-Steel Centennial Series Pergola

### Arborview Pergola

With its unique round pickets the Arborview Pergola will add a great deal of visual interest to your park or garden setting.

Select from one of our standard Litch-Kicker colors for a more traditional pergola look or select a custom color or colors (as pictured) to give the Arborview a fun and funky look which, for example, can complement a playground design such as Jack and Jill Park in Albuquerque, New Mexico.



### Centennial Series Pergola

Need a partial shade shelter for a large open area? The Centennial Series Pergola is the perfect choice due to its massive size. The Centennial Series is a 16' X 50' X 99' All-Steel Straight Beam Pergola with square columns. Allow us to design a shade solution which will accommodate your site needs.



Model 9760 Custom 7'-3"X134' All-Steel Curved Beam Arborview Pergola with 3" round radial beams (paint finish by others)



Model 9750 Custom 50' X 99' All-Steel Centennial Series Pergola

(800) 542-5282

## GARDEN GALLERY PERGOLAS



Model 9730 8' X 140 All-Steel Senn Park Curved Beam Pergola with square columns

### Senn Park Pergola

The Senn Park Pergola's cantilevered design allows for the use of less columns which creates an airier, less cluttered pergola design. This is the perfect pergola design for park users who want to sit down, relax and take in the view at their favorite park or public gardens.



Model 9730 8' X 140° All-Steel Curved Beam Pergola with Square Columns

**Curved Beam Pergolas  
are based on 30° increments**

Pergola Options:

- Square, Rectangular or Round Radial Beams
- Square, Rectangular, Round or Quad-Steel Columns (Straight or Stepped)
- Perfa-Lite Perforated Metal Roofing (for more details see p. 74)
- Roof Pitches: 4:12, 6:12, 8:12 or flat



Model 9770 Custom 15'X35' Town Square All-Steel Pergola (column masonry by others)

### Town Square Pergola

A straight beam pergola with Craftsman-inspired stepped support beams. The design utilizes all-steel construction including square column supports and rectangular pickets. This simple, classic design will look just perfect at the center of your town square!



Two Model 9770 Town Square All-Steel Pergolas creates a unique focal point to this park



Color rendering of the Model 9770 Town Square Pergola illustrating the Craftsman-inspired stepped support beams.

## GARDEN GALLERY PERGOLAS

### Garden Gallery Pergolas can be Decorative, Functional or Both!

The Garden Gallery Series offers a wide array of pergola styles and sizes which can be customized to suit your site requirements or design aesthetics. For example, pictured below, is our Garden Gallery Gable End Entrance Gateway. This beautiful pergola follows not only form but function too. Allow us to create a Garden Gallery Pergola to fit your needs beautifully!



Model 9900 Custom 25'X7'-5" Pittsburgh "Pergola Style" Gable End Entrance Gateway with 2 column design, corner braces and custom white Litch-Kicker frame finish (column masonry by others)

**Curved Beam Pergolas are based on 30° increments**

#### Pergola Options:

- Square, Rectangular or Round Radial Beams
- Square, Rectangular, Round or Quad-Steel Columns (Straight or Stepped)
- Perfa-Lite Perforated Metal Roofing (for more details see p. 74)
- Roof Pitches: 4:12, 6:12, 8:12 or flat

(\*) Column masonry by others

### Cabana Style Pergola

Relax by the pool in style with our Cabana Style Pergolas. Fabri-Cover fabric roofing material is available for the Cabana Style Pergola (see pages 38 & 39 for details).



Model 9710 Custom 135'X14'X120, Raritan Bay Pergola featuring attached straight beam pergola extensions at each end. Also located at each end is a Model 8716P Custom 20' Cabana Style Pergola (column masonry by others).

### Riverwalk Pergola

Inspired by the lush landscaping and unique architecture of the San Antonio River Walk, the Riverwalk Pergola has a curved pergola top which is perfect for growing beautiful vining plants. Along with the gently curving wood laminated beams the Riverwalk Pergola is a wonderful choice to accent a rest area along a walking trail, river or stream.



Front view of Model 9740 10' X 10' Riverwalk Laminated Curved Beam Pergola top showing laminated arched beams, stepped columns and round finials



Model 8716P Custom 20' Cabana Style Pergola featuring custom header beams, square banded steel columns and white Litch-Kicker paint finish (\*)



Model 9740 10' X 10' Riverwalk Laminated Curved Beam Pergola featuring round stepped columns with round finials

(800) 542-5282

# FABRI-COVER SHADE STRUCTURES

Play it Cool...



Model 4501 Square



Model 4507 Dual Column Umbrella



Model 4501 Square

...by taking advantage of the UV Blocking Strength of our Fabri-Cover Shade Structures!



New Revolutionary Patent Pending  
Glide Elbow

Our revolutionary, patent pending, **Glide Elbow** was designed with you, the owner, in mind. In case of unusual or unexpected weather, such as tornadoes, hurricanes or snow storms, the fabric can be removed quickly and safely.

Easy installation and removal of your fabric is completed with the use of a simple wrench. Our **Glide Elbow**, not the weather, will be in control of your investment for many years to come.

Just a few of the benefits of Fabri-Cover products include:

- Protect your play equipment investment
- Our fabrics provide up to 80% water repellency
- Your play structures will be cooler to the touch
- Our fabrics provide up to 97% UV protection, which protects children from harmful skin damaging sunburns
- Around sports fields, our canopies provide protection from misdirected, high-flying balls
- Our superior Glide Elbow enables you to remove and re-install canopies very quickly in case of unusually severe weather
- Both our high-gloss powder coated steel frames and outstanding UV block fabrics come in a wide variety of pleasing colors, which you can match as you choose

# FABRI-COVER SHADE STRUCTURES

## Listen to the Facts and Play Cooler!

- Fabri-Cover Shade Netting Features
- 10 year limited warranty
- UV stabilized high density polyethylene ASTM 84
- Blocks up to 97% harmful UV rays
- Provides up to 91% shade
- Fire rating NFPA 701
- Fade resistant
- Mildew and rot resistant
- 80% water repellent
- Fabric breaths allowing hot air to rise and escape creating a cool cushion underneath
- Provides hail protection
- Available in a wide variety of colors
- Will not sag or loosen over time - due to a process called stentering, fabric memory will keep it looking new



Model 4508 Cantilever

## Fabri-Cover Structural Steel Features

- Engineered to withstand 80-150 miles per hour wind, depending on requirements.
- Meets uniform building codes ASTM A-36, A-53, A500, A513, and A-569.
- Custom design for superior strength
- Durable and corrosion resistant
- Column options available for all Fabri-Cover Shade Structures include: square, round, rectangular, standard quad, premium quad and stepped columns

## Available Sizes

Range from 10'X10' up to 100'X66'. Please contact the Litchfield office or your local Litchfield representative for more details.

## Fabri-Cover Shapes

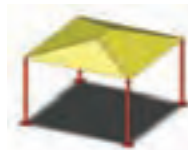

Square

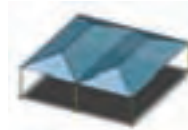

Double Dome



Superdome

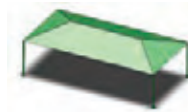

Short Rectangle

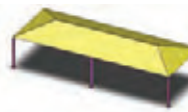

Long Rectangle



Swings

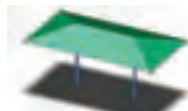

Dual Col. Umbrella



Cantilever



Umbrella



Octagon



Hexagon



Square Quad Sail



Model 4512 Square Quad Sail



Model 4509 Umbrella

## Fabri-Cover Colors



Aquatic Blue



Black



Brunswick Green



Cherry Red



Desert Sand



Natural



Navy Blue



Ocher Red



Rivergum Green



Sky Blue



Steel Grey



Turquoise



Yellow

Printed colors may not match actual colors. Contact factory for color sample.

(800) 542-5282

# LAMINATED SHELTERS

## Series 1300 Laminated Hexagonals



available sizes: 20', 25', 30', 35', 40', 45', 50', 60'

Model 1332 30' Laminated Hexagonal with Cedar shingles and a vented cupola



Above: Optional steel column

Above Left: Model 1328 25' Laminated Hexagonal with 24 gauge metal roofing

Left: Laminated Beams and Purlins

## Series 7900 Laminated Squares



available sizes: 16', 20', 25', 30', 35'

Model 7916 16' Laminated Square with fiberglass shingles

The Laminated Series Shelters utilize straight architectural grade glue-laminated beams and purlins on top of pressure-treated southern yellow pine columns. Hexagonal, Octagonal and Square shelters are available in a variety of sizes.

Standard shelter materials are: Pressure-Treated Columns, Laminated Beams and Purlins, and 2" X 6" Southern Yellow Pine T&G Roof Decking.

Options available are: Laminated or Steel Columns, Cedar 2" X 6" T&G Roof Decking & Fascia, Wood Handrails and Overhead Lattice, Steel Handrails and Overhead Lattice, Wind Bracing, Cupola, Fiberglass or Cedar Shingles, Litch-Top Pre-cut Metal Roofing. Custom: Standing Seam Metal Roofing.

## Series 7200 Laminated "Stretched" Hex



available sizes: 30'X52', 30'X68', 30'X84'

Model 7253DSM Custom 30'X52' Laminated "Stretched" Hex with 29 gauge metal roofing and optional vented roof

Hexagonals, Octagonals and Squares can be "stretched" to create an elongated shelter. The stretched shelters also have the option of adding a vented roof.

## Series 1600 Laminated Octagonals



available sizes: 22', 29', 33', 38', 45'

Model 1699 Custom 26' All-Cedar Octagonal Duo-Top with Cedar lattice, handrails, wind braces and 2"X6" Southern Yellow Pine T&G roof decking. Roofing material by others.



# LAMINATED CURVED BEAM RECTANGULARS

## Series 1700 Laminated Curved Beam Rectangulars

Architectural grade glue-laminated southern yellow pine members make up this popular series of shelters. Choose from a number of Gable-End or Dutch Hip-End Rectangular shelter sizes.

The Laminated Curved Beam shelters are available in free-span widths of 12', 16', 20', 22', 24', 28', 30', 40' and 50'. The minimum length of a shelter is 20' (two 8' bays with 24" overhangs) for the shorter spans. Other lengths are 28', 36', 44', 52', 60' and 68' (+ additional 8' bays). The roof decking is hand-select #2 Southern Yellow Pine 2" X 6" tongue & groove roof decking. Columns are pressure-treated Pine but optional steel columns are available.



Model 1721DH 30' X 52' Laminated Curved Beam Dutch Hip with pressure treated Pine columns, fiberglass shingles, optional cupola and optional weather vane

Options include:

- Western Red Cedar T&G Roof Decking
- Laminated Columns (straight or stepped)
- Steel Columns (square, rectangular, round or Quad)
- Pre-Cut Litch-Top Metal Roofing
- Standing Seam Metal Roofing (upgrade available)
- Fiberglass or Cedar Shingles
- Wood or Steel Handrails
- BBQ Vented Roof
- Cupola



Model 1744 20'X44' Laminated Curved Beam Gable End with 2"X6" Southern Yellow Pine T&G roof decking, fiberglass shingles and optional steel columns



Laminated Curved Beam ceiling with 2"X6" Southern Yellow Pine Tongue & Groove roof decking

A full-length Barbeque Vent was added to this "L" shaped Laminated Curved Beam shelter. Also shown with optional wood handrails and fiberglass shingles.



Model 1745 40' X 60' Laminated Curved Beam Gable End shelter with 2"X6" Southern Yellow Pine T&G roof decking, 29 gauge Litch-Top pre-cut metal roof and optional steel columns.

# LAMINATED SOLID ARCH SERIES

## Series 2000 Rectangular Solid Arch



Standard Widths: 20', 30' and 40'

Standard Lengths: 44', 52', and 60'  
(8' sections can be added to any length)

Above: Model 2031 30'X44' Laminated Rectangular Solid Arch Gable with 2"X6" Southern Yellow Pine T&G roof decking and fiberglass shingles

## Series 2000 Solid Arch Dutch Hip



Standard Widths: 20', 30' and 40'

Standard Lengths: 44', 52', 60' and 68'  
(8' sections can be added to any length)

Above: Model 2025DH 20'X52' Solid Arch Dutch Hip

A standard feature exclusive to the Solid Arch Dutch Hip are vertical boards in the dutch hip gable ends.

## Series 7100 Rectangular Solid Arch Hip



Standard Width: 22'

Standard Lengths: 36', 44', 52' and 60'  
(8' sections can be added to any length)

Above: Model 7122 22'X44' Rectangular Solid Arch Hip with 2"X6" Southern Yellow Pine T&G roof decking and fiberglass shingles

## Series 1800 Laminated Solid Arch Hexes



Standard Sizes: 20', 25', 30', 35', 40', 45'

Above: Model 1836 35' Laminated Solid Arch Hexagonal with fiberglass shingles

## Series 2300 Laminated Solid Arch Squares



Standard Sizes: 20', 30', 40'

Model 2320 40' Laminated Solid Arch Square with 2"X6" Southern Yellow Pine T&G roof decking and fiberglass shingles

### Series 2000 & 7100 Standard Features:

- Solid Laminated Arch Columns with pressure treated Pine lower arches
- 2" X 6" Southern Yellow Pine T&G Roof Deck
- Pressure-treated Fascia
- Galvanized Steel Base Shoes

### Series 2000 & 7100 Options:

- Cedar Roof Deck and Fascia
- Fiberglass or Cedar Shingles
- Pre-cut Metal roofing
- Handrails
- Custom Roof Pitch

### Series 1800 & 2300 Standard Features:

- Pressure-treated Pine columns
- 2X6 Southern Yellow Pine T&G Roof Deck

### Series 1800 & 2300 Options:

- Cedar T&G Roof Decking
- Cupola
- Fiberglass or Cedar Shingles
- Pre-cut Metal Roof

## LAMINATED RAINBOW ARCH SERIES

The gothic feel of these laminated open arches creates an attractive yet strong framework that resembles the flying buttresses of the renaissance cathedrals. These three part arches, made up of post, arch and beam are assembled on-site to allow for shipping in a knocked-down bundle. The posts and arches are laminated, pressure-treated pine, and the beams are laminated pine. Some field drilling is required during installation.



### Series 2600 Laminated Rainbow Arch Rectangular

Standard Widths:  
20', 30', 40'

Standard Lengths:  
44', 52', 60'

### Series 2100 Laminated Rainbow Arch Hexagonal

Standard Sizes: 16', 24', 32'

Left: Model 2126 24' Laminated Rainbow Arch Hexagonal shelter with optional cedar shingles. Stain applied locally.

#### Rainbow Arch Series Features:

- Glue Laminated Pine Arches, Columns and Purlins
- Pressure Treated Fascia
- 2" X 6" Southern Yellow Pine T&G Roof Decking

#### Rainbow Arch Options:

- Cedar 2"X6" T&G Roof Decking
- Cedar or Fiberglass Shingles
- Cupola
- Wood Handrails
- Corner Bracing

Additional sizes may be available. Please contact the Litchfield Sales Office, or your local Litchfield Sales Representative.

### Series 6800 Laminated Rainbow Arch Octagonal

Standard Sizes: 24', 28', 40'



Model 2652 Custom 28'X52' Laminated Rainbow Arch Gable End with fiberglass shingles



Model 6829 28' Laminated Rainbow Arch Octagonal with optional fiberglass shingles and lightning protection

(800) 542-5282

# RUSTIC SERIES SHELTERS

## Series 1400 Woodland Gable



Roof Span: 22'-0" Lengths: 24', 36', 48' & 60'

Model 1449 22' X 48' Woodland Gable with fiberglass shingles, without fascia

## Series 2400 Woodland Dutch Hip



Roof Span: 22'-0" Lengths: 27', 39', 51' & 63'

Above: Model 2452 22' X 51' Woodland Dutch Hip with fiberglass shingles

The Rustic Series shelters utilize economical wood truss construction to provide you with the maximum coverage at a reasonable cost

The 22' wide Woodland is available in gable end, dutch hip end or a full hip end roof configurations. The 28' Timbercraft is available as gable end or dutch hip. The standard Woodland and Timbercraft Series shelters have T&G barn siding for the gable end and the dutch hip end, 2" X 6" Southern Yellow Pine T&G Roof Decking, pressure-treated Pine Columns and fascia, and solid wood trusses.

Options include steel columns, fiberglass or cedar shingles, pre-cut metal roofing, and a barbeque vented roof cap design.



Optional Full Hip Design



Model 2465 22' X 63' Woodland Dutch Hip with Cedar shingles

## Series 1500 Timbercraft Gable



Roof Span: 28'-0" Lengths: 32', 40', 48', 56' & 64'

Above: Model 1533 28' X 32' Timbercraft Gable with fiberglass shingles, without fascia

## Series 2500 Timbercraft Dutch Hip



Left: Model 2560 28' X 58' Timbercraft Dutch Hip with Cedar shingles, without fascia



Roof Span: 28'-0" Lengths: 34', 42', 50', 58' & 66'

Above: Model 2566 28' X 66' Timbercraft Dutch Hip with pre-cut metal roof (enclosure by others). Custom white stain applied locally by others.

# RUSTIC SERIES SHELTERS

## Series 1000 Wood Mini Shelters



Model 1015 10' X 10' Wood Mini Shelters with picnic tables in Pine

**Standard Sizes:**  
8' X 8', 10' X 10' & 12' X 12' (open gables)

Litchfield Wood Mini-Shelters can be installed as open structures, or with any of the following optional accessories: picnic tables, single or double benches, bike racks and single or double message boards.

### Standard Features:

- Treated Pine Columns
- Solid Pine Beams, Trusses & Roof Deck
- Cedar Shingles

### More Options:

- Redwood Construction
- Pre-cut Litch-Top Metal Roofing
- Fiberglass Shingles



Model 1086 8' Wood Mini-Shelter with Single Sided Message Board

## Series 1200 All-Weather Shelters



**Roof Span: 15'-0"    Lengths: 18', 24', 30'**

Above: Model 1224 15' X 18' All-Weather Shelter with fiberglass shingles

### Standard Features:

- Treated Pine Columns
- Solid Pine Beams & Trusses
- T&G Roof Decking
- 1" X 8" T&G Barn Siding (for the gable ends)

### Options:

- Litch-Top Pre-cut Metal Roof
- Cedar or Fiberglass Shingles
- Steel Columns

## Series 1100 Barbeque Shelters

The Series 1100 Barbeque Shelter features a full-length vented roof to allow for the release of cooking smoke. Other features and options are the same as listed above for the All-Weather Shelter.



**Roof Span: 15'-0"    Lengths: 20', 26', 32'**

Right: Model 1175 15' X 32' Barbeque Shelter with fiberglass shingles

## CENTURION STEEL ENTRY GATES

Litchfield proudly offers our exclusive line of Centurion All-Steel Swing-Style Entry Gates which we custom build in our fabrication shop to the rigid specifications of our customers. The standard swing length is 12'-6" measured from the center of the pivot to the end of the arm but lengths can vary based on need. Maximum "single swing" length is 20' and maximum "double swing" gate length is 40'. All



Model CSG-209 Curved Beam Single Swing Gate with circle pattern Custom color shown. Column masonry by others.

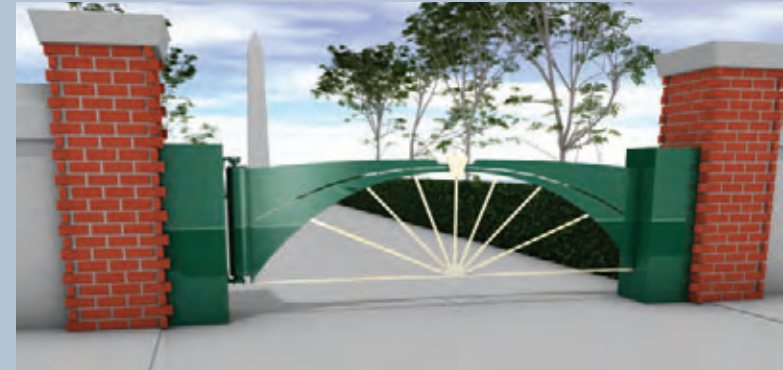

Model CSG-210 Arched Double Swing Gate with radial pickets in Adobe Tan & Forest Green Litch-Kicker Paint Finish. Column masonry by others.

associated hardware including a hinge or hinges utilizing 2-ton bearings and a locking mechanism for either the single or double swing styles are standard. As an option, electrical access holes can be added (at an additional charge) for lighting fixtures or to mount a security video system. Litchfield utilizes laser-cutting technology to create a number of our steel entry gate designs. Select from the attractive design choices shown here or use your imagination and provide us with your own custom design idea!

Centurion Steel Entry Gates are made of welded tubular steel which is sandblasted to a near white condition to remove dirt and oils, then coated with our Litch-Kicker finish to provide many, many years of service. Select from one of our standard Litch-Kicker colors (see page 76) or provide us with an RAL number for a custom color. Custom colors and powder coating is available at an additional charge.



Model CSG-201 Arched Style Double Swing Gate (electrical access shown; lighting by others)



Model CSG-203 Straight Beam Double Swing Gate with square pattern



Model CSG-205 Arched Style Double Swing Gate with circular pattern (electrical access shown. Lighting by others)

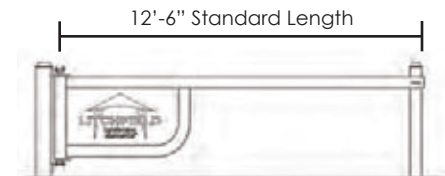

Model CSG-207 Straight Beam Single Swing Gate with laser-cut insert and curved support (we can customize with your logo)



Model CSG-202 Ranch-Style Curved Beam Double Swing Gate



Model CSG-204 Straight Beam Single Swing Gate with diamond pattern (simulated stone pivot posts by others)



Model CSG-206 Dual Curved Beam Double Swing Gate



Model CSG-208 Straight Beam Single Swing Gate with laser-cut insert and morticed support (we can customize with your logo)

## KIOSKS AND MESSAGE CENTERS

### Series 7700 Kiosk

This fully assembled 54" hexagonal kiosk in pressure-treated Pine has (6) hinged and lockable plexiglass display case doors and are framed in Pine and inlaid with corkboard. Options include all-Cedar construction, Cedar or fiberglass shingles and pre-cut metal roofing. Available without the roof for indoor use.



### Model 1020 Two Post Message Center

Offered in Pine, Redwood or Steel 2-column design. Single or double-sided lockable display cases available. Comes with 29 gauge metal roof.



### Model 7751 Four Post Hipped Message Center

Roof measures 6' X 9'. Has Single or double-sided lockable display cases.



### Model 9030 Three Post Message Center

8' Triangular Roof  
Has three 4' X 4' lockable display cases  
(custom frame color additional)  
(column masonry by others)

## THE MAIN STREET COLLECTION



Available Lengths: 6' & 8"

Above: Model 5920 6' Main Street Bench with back (fully assembled)



Available Lengths: 6' & 8"

Above: Model 5922 6' Main Street Bench without back (fully assembled)



Available Lengths: 6' & 8"

Above: Model 5940 6' Main Street Grand Central Bench featuring steel slats and cast frames

The Series 5900 Main Street Collection of site furnishings revives a handsome and classical style. Main Street's simple elegance adds a sense of timelessness to any setting, while their all-steel construction and Litch-Kicker or powder coat finishes provide durability and longevity.



Available Lengths: 7', 9', 11'  
Material: 2-3/8" outside diameter steel pipe  
Installs: In-ground only

Above: Model 5995 9' Main Street Wave Bike Rack



Available Lengths: 5' & 10'  
Installs: Surface or In-ground

Above: Model 5980  
5' Main Street Ring Rack



Model 5930 30" Tall  
Main Street Ash Urn  
(12" diameter)

**Note:** for powder coat color selection, please refer to the color chart on page 75.

### Main Street 32 Gallon Heavy Metal Litter Receptacle

This is our toughest receptacle available. It comes complete with steel cable attached to retain the spun metal inset lid. It is lockable and vandal resistant. Comes with high density plastic liner. Options include a 32 gal. galvanized liner, spun metal dome top, and a stainless steel ash tray. Anchor holes in the base allow for permanent surface mounting.



Model 5900  
Heavy Metal Litter  
with standard high  
density plastic liner

Model 5900  
Heavy Metal Litter  
with optional  
galvanized liner

Model 5900  
Heavy Metal Litter with  
optional galvanized  
liner & aluminum ash tray

### Main Street 36 Gallon Litter Receptacle

This attractive litter receptacle features solid steel slats and heavy steel circles. It is 24" in diameter and 36" high. Anchor holes in the base allow for permanent surface mounting, comes with a high density plastic liner. Shown with optional funnel top.



Model 5936  
Main Street Litter



## INFINITY SERIES ALL-STEEL BENCHES

The softly curving all-steel slats featured on our Infinity Series Benches presents a number of creative seating options including semi-circular, circular and S-curve shapes. Infinity benches are available with or without backs. To further customize your Infinity Series Bench the bench supports can be laser-cut to fit any design style you desire. Infinity Series Benches can be direct buried or surface mounted.

### Model 3540 Infinity Series All-Steel Circular Bench



Model 3540 6' Infinity Series All-Steel Circular Bench with custom laser-cut bench supports



### Model 3550 Infinity Series All-Steel Curved Backless Bench



Model 3550 Infinity Series Curved Backless Bench with hoop supports. Also available with back and gull leg supports

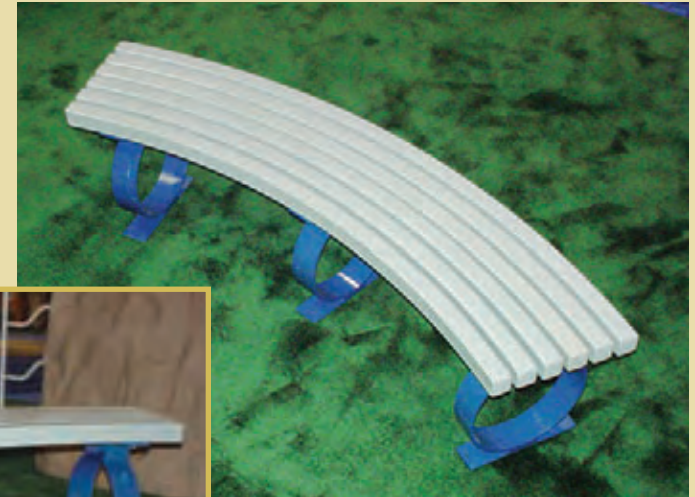

Elevated view of Model 3550 Infinity Series Curved Backless Bench with hoop supports. Also available with back and gull leg supports.

Left: Close-up view of a custom laser-cut bench support from the Model 3540 Infinity Series Circular Bench. Bench supports can be laser-cut to fit any desired design style.

Far Left: Model 3540 6' Infinity Series circular bench shown with Model 8008-P All-Steel "Umbrella-Style" Hexagonal Single Post Shelter (see page 21 for more details regarding Model 8008-P)

Right: Color rendering of a Model 3540 6' Infinity Series Circular Bench mounted to a 5"X5" center support post. All hardware is stainless steel. Available as direct bury or surface mount (shown here).



# CLASSIC BENCHES



Model 3123  
Grand Central Bench  
with 6' Oak slats

## Series 3100 Grand Central Bench

As strong and durable as they are beautiful, these classic benches can be used indoors or out, at parks, in malls, terminals or lobbies. The Grand Central Bench has twelve 1-3/8" X 2-3/8" wood slats. The heavy cast-iron ends are finished with Litch-Kicker in black. Lengths available are 4', 5' and 6' as a single bench. The addition of a third center casting allows for 8', 10' and 12' lengths (below left: Model 3134, 10' Purpleheart).



Model 3134 Grand Central Bench  
with 10' Purpleheart slats



Baby Grand Deluxe Bench  
Available in 4', 5' and 6' Lengths  
Pictured: Model 3147 5' with Redwood



Grand Table & Benches  
Table Available in 4', 5' and 6' Lengths  
Pictured: Model 3138 6' w/ Purpleheart  
shown with Baby Grand Benches



Baby Grand Bench  
Available in 4', 5' and 6' Lengths  
Pictured: Model 3142 5' with Redwood

## Series 3150 World's Fair Bench

The World's Fair Bench has two cast-iron ends with eight 1" X 2-1/2" slats and one 1" X 3" slat. Additional castings can be added to make 10' and 12' models.



Available in 5', 6' & 10' lengths

Above: Model 3153 World's Fair Bench  
with 6' Oak slats

## Series 3110 Bostonian Bench

The Bostonian Bench has two ornate cast-iron ends with twelve 3/4" slats of various widths. Shown is Model 3113, 5' with Oak slats. The slats fit very close together to form a very comfortable contour seat.

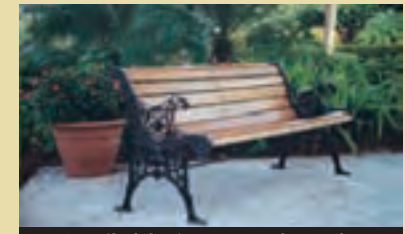

Available in 4' & 5' lengths

Above: Model 3113 Bostonian Bench  
with 5' Oak slats

## Series 3100 Liberty Bench

Three cast-iron frames support seven 2" X 4" slats. The Liberty Bench is standard at a 6' length, although longer models are available upon request.



Model 3100 Liberty Bench with 6' Pine slats

### Available Woods for Series 3120, 3100, 3150 & 3110:

Treated Pine, Clear Redwood,  
#1 Oak, Douglas Fir, Ipe, Mahogany,  
and Purpleheart.

It is not recommended using Oak  
for outdoor installations.

Slats have eased edges and are pre-drilled  
for stainless steel hardware attachment.

## CONTOUR BENCHES



### 18-Slat Contour Bench

The 18-Slat Contour Bench features sixteen 1-1/4" X 1-3/8" slats and two 1-1/4" X 2-3/8" outside slats. Contour frames are 3/8" X 4" steel straps. Shown is Model 3082 18-Slat Contour Bench with 6' Oak slats and gull leg.



### 8-Slat Contour Bench

The 8-Slat Contour Bench features eight 3" X 4" nominal slats. Shown is Model 3041 8-slat Contour Bench with 6' Pine slats and gull leg supports.

### 13-Slat Contour Bench

The 13-Slat Contour Bench features thirteen 2" X 3" nominal slats on contour frames of 3/8" X 4" steel straps. Shown is Model 3020 13-Slat Contour Bench with 6' Redwood slats in-ground.



Left: Model 3025 13-Slat Contour Bench with 8' Redwood slats and Model 3020 13-Slat Contour Bench with 6' Redwood slats. Both have optional surface mount plates and optional arm rests.



### Wall Mount Contour Bench

This 6' 13-Slat Contour Bench is shown with wall mount support brackets and oak slats. Brackets can be mounted to most vertical surfaces. Model 3032 13-Slat Contour Bench with 6' Oak slats and optional wall-mount brackets.



### Single Seat Contour Bench

This 2' wide single seat version of the 13-Slat Contour Bench is shown with single surface mount plate supports and Redwood slats. Shown is Model 3061 13-Slat Single Seat Contour Bench with Redwood slats & optional arm rests.



### Single Post Contour Bench

This 8-Slat Contour Bench is shown with single in-ground mount support and Redwood slats, Model 3052SP

The Series 3000 Contour Benches show off the beauty of wood more than any other. Choose from the 8-slat, 13-slat or 18-slat styles. Wood types available are: treated Pine, Redwood, Douglas Fir, Mahogany, Oak, Purpleheart and Ipe. Most of the standard contour benches are available with one-of-three different mounting styles: in-ground, surface-mount plate, and portable gull leg. Each style of contour bench is offered in 6' and 8' lengths. Optional styles include a single post, in-ground mount, wall-mount brackets, arm rests, and single seats.

(800) 542-5282



# WOOD BENCHES

## Series 3300 Victory Bench

Available in 6' and 8' lengths, the 14-Slat Victory Bench features 1-3/8" X 2-7/8" wood slats with eased edges and pre-drilled holes for stainless steel hardware attachment. The Victory Bench strongly resembles our Contour Benches. The difference is the orientation of the slats, and that the fasteners are not seen from the front. Wood slat choices and mountings are the same as those for the Contour Benches.



Model 3312 Victory Bench with 6' Purpleheart slats and in-ground supports



Model 3313 Victory Bench with 6' Purpleheart slats and gull-leg supports

## Series 3200 Landscape Bench

Available in 6' and 8' lengths. Slats are Pine, Redwood, Purpleheart, Oak or Ipe. It can be ordered with permanent, in-ground or surface-mount gull-leg supports. With or without a back, this popular model can be ordered with 2X4, 3X4 or 4X4 slats.



Model 3242 6' Landscape Bench with 3"X4" Redwood slats, in-ground supports & back



Model 3225 6' Landscape Bench with 2"X4" Redwood slats, gull-leg supports & no back

## Series 3800 Dearborn Bench

Available in 6' and 8' lengths. Slats are 4X4 nominal Pine, Douglas Fir, Redwood, Purpleheart or Ipe. It can be ordered with permanent, in-ground or surface mounted supports.



Above: Model 3805 Dearborn Bench with 6' Redwood slats, back and surface mount supports

Left: Model 3825 Dearborn Bench with 6' Redwood slats, surface mount & without back

## Series 3350 Burlington Bench

Available in 6' and 8' lengths, with 2-3/8" O.D. steel pipe frames. Slats are 3X4 nominal Pine, Redwood, Cedar, Purpleheart or Ipe. It can be ordered with permanent in-ground (at additional cost) or surface plate-mounted supports.



Above: Model 3351 Burlington Bench with 6' Pine slats, back & plate mount supports

Left: Model 3352 Burlington Bench with 6' Pine slats, in-ground & without back

## Series 6600 Hoop Bench

Available in 6' and 8' lengths. Four seat slats and three back slats are 3X4 nominal Pine, Douglas Fir, Redwood, Mahogany or recycled plastic. It can be ordered with permanent in-ground or moveable surface mounted supports.

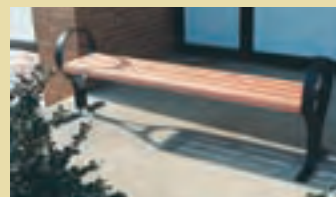

Above: Model 6610 Hoop Bench with 6' Redwood slats, with back & gull-leg supports

Left: Model 6611 Hoop Bench with 6' Redwood slats, gull-leg supports & without back

# WOOD BENCHES

## Series 3700

### Hex Mall Bench

The Hex Mall Benches have center openings from 44" to 127", and are available in Redwood or Treated Pine.

Right: Model 3710 Hex Mall Bench in 65" Redwood with in-ground supports



### Series 3400 Low Rider Bench

Available in lengths of 6' and 8', it has a turned up seat of four 2X4 slats in treated Pine, Redwood or Oak. An optional back is available, and the supports can be permanent in-ground or surface mount gull-leg.



Model 3409 in Redwood with gull-leg supports

### Series 3400 Players Bench

Available in lengths from 2' to 12', it has a seat of strong electronically bonded, edge-grained Michigan maple laminate. The surface mounted gull-leg supports are powder-coated black.



Model 3454 6' with gull-leg supports

### Series 3900 Deluxe Bench

Constructed entirely of treated Pine or Redwood, with or without a back. Legs are 6X8, seat braces are 4X4, and seat and back planks are 3X6. All components are pre-drilled and countersunk for easy attachment in the field.



Model 3953 6' Deluxe Bench in treated Pine

### Series 3900 Rustic Bench

Capped galvanized pipe frame with 2X4 nominal slats in 6' or 8' treated Pine or Redwood. Available with permanent in-ground supports only.



Model 3901 6' Rustic Bench in treated Pine

## Series 5100 Mall Benches

Well suited to both indoor and outdoor use, from shopping malls to lobbies, and outdoor rest areas, the Mall Series Benches are versatile, durable and attractive. Slats are 2X4 nominal spaced with phenolic spacers and locked together with internal steel rods. Available in 6' and 8' lengths, with or without a back, in Pine, Redwood, Mahogany, Oak, Purpleheart and Ipe. Mounting steel frames are finished in black enamel, and can be either permanent in-ground, or surface mount with a plate or gull-leg. Optional polyurethane finish on wood slats for indoor use. Oak is not recommended for prolonged outdoor use.

The Regular and Square Mall Benches are open on the ends. The Box Mall Benches have a "boxed in" frame of 2X6 nominal perimeter slats offset from the 2X4 slats with 1/2" wood spacers. All slats have eased edges for comfort.

### Standard Mall & Square Mall Bench

The Standard Mall Bench is available in 6' and 8' lengths, with or without a back. The Square Mall Bench is 2' square, and is available without a back only. Available in treated Pine, Redwood & Oak.



Model 5158 Square Mall Bench in Oak with surface mount plate



Model 5102 Standard Mall Bench 6' Pine, gull-leg with back



### 90° Mall Bench and Straight Box Mall Bench

Model 5163 Straight Box Mall Bench, 6' Pine with in-ground supports

The 90°Box Mall Bench is available as a 6' X 6' corner without a back. The Straight Mall Box Bench is available as 4', 6' and 8' without a back. Both are available in treated Pine, Redwood & Oak.



Model 5144 90° Box Mall Bench 6' X 6' in Pine with in-ground supports

## PARK TABLES



Model 4330 American table in 4X4 Redwood, single post in-ground support

### Series 4300 American Tables

The American Table is available in both square and rectangular configurations. The single, center post, buried in-ground, gives a clean, uncluttered appearance. Optional surface mount plate available at an additional cost.

Woods are either treated Southern Yellow Pine or Redwood. Also available in Earthcare Series recycled plastic lumber (see page 57 for details and colors). The original 4X4 tables are offered in 2X4, 3X4 or 4X4 construction. The 3X3 is also available with 3" X 10" planks. The square tables are available with and without seat backs. The 6' rectangular tables are offered with 2X4, 3X4 and 4X4 wood members.

Redwood is finished with Homoclad Sealer to retain the wood's rich, reddish color. The treated Pine is finished with Walnut Brown oil stain.



Model 4309 3' Square American Table in 3X4 Redwood with seat backs and optional 4390 Checkerboard (shown at right)



Model 4321 4' Square American Table in 3X4 Redwood with seat backs



Model 4332 6' American Table in 2X4 treated Pine, in-ground support



Model 4340 3' Square American Table in 3X10 Redwood without seat backs



Optional: Model 4390 Checkerboard. Available for most wood and recycled tables (please inquire).

### Series 4800 Dearborn Tables

The table measures 38" X 40". Seats measure 19" X 18-1/2". Both are available with surface mount or in-ground supports. The seats are available with or without backs. Tables and seats are sold separately. Offered in Pine or Redwood.



Model 4800 Dearborn Table in Redwood with in-ground support and (4) Model 4810 Dearborn seats in Redwood (sold individually)

### Series 4200 Rustic Saddle Seat

A Litchfield classic! The seats are supported by a welded steel ring connected to massive 6X6 Pine, Redwood or recycled legs. Top boards are 2X10 nominal lumber. Frame is finished in our standard black or brown enamel. Sizes available are 40" diameter, 4-Seat and 54" diameter 8-Seat models.

Available in ADA with minimum seating for four.



Model 4240 54" 8-seat Rustic Saddle Seat Table in Redwood. Shown with optional umbrella.

# PARK TABLES

## Series 9500 Rustic Park Table

This handy design is available with high tensile 1-5/8" or 2-3/8" outside diameter galvanized pipe frames with 1/8" minimum wall thickness. Table Top and seat frames use 10-gauge galvanized steel. Diagonal braces are 15/16" outside diameter high tensile galvanized pipe. Table top and seat boards are 2X10 nominal #1 Southern Yellow Pine. Available in either untreated or ACQ pressure treated, and recycled plastic. Choose between 6', 8' and handicap-accessible models.



Model 9522 6' Rustic Table with 2-3/8" galvanized pipe frame in treated Pine



Model 9531 6' Rustic Table with 1-5/8" galvanized pipe frame in treated Pine

## Series 4000 All-Wood Deluxe Table & Series 4100 Traditional Table

Deluxe tables have 6X6 legs and 4X4 cross braces and seat braces, pre-drilled and countersunk. The Traditional tables have 4X4 legs with mortised construction for extra strength. Cross braces and seat braces are 3X3, pre-drilled and countersunk. On both, tops and seats are #1 2X10 nominal boards. Hardware is stainless steel. Available in 6' and 8' lengths. Materials are #1 Southern Yellow Pine, with or without Walnut Brown oil stain, or Redwood with Homoclad sealer. Top shipped assembled.



Model 4063 6' Deluxe Table in unfinished Pine



Model 4163 6' Traditional Table in unfinished Pine

## Series 4400 Mountaineer Tables

The Mountaineer table is constructed of 4X6 slats in Redwood or pressure-treated pine on a welded steel frame. The seats are available with or without backs (if ordered with backs, designate using "SB" after the model number). The 4' square table is portable only. The 6' and 8' rectangular tables can be portable or permanent in-ground installation. Mountaineer Series tables are available in wheelchair accessible designs.



Model 4428 6' Mountaineer Table in Redwood, portable



Model 4444 4' Square Mountaineer Table in Redwood with seat backs

## Little Seats

Little Seats are the perfect picnic spots for the kids. We offer the same comfortable, durable designs of our standard Mountaineer or Deluxe Series tables in a reduced scale for smaller appetites.



Model 4445 "Little Seats" Mountaineer Table with 2"X6" Pine slats, portable



Model 4419 8' Mountaineer Table in Pine, portable

# WOOD LITTER RECEPTACLES



## Series 5200 Mall Litter

- Steel swing-top design
- Available in Pine, Redwood and Oak
- Shipped assembled
- Galvanized Liner
- Size: 32 Gallon

Model 5253  
32 gallon Mall Litter in Redwood



## Series 5300 Square Litter

- Swing-top design
- Available in Pine, Redwood, Oak and recycled plastic
- Shipped assembled
- Galvanized liner
- Size: 32 gallon
- Polyurethane finish available



Model 5330 32 gallon  
Square Litter  
in recycled plastic

Model 5324 32 gallon Square Litter  
in Redwood



## Series 5400 Round Litter

- Portable or In-ground
- Available in 2" X 4" nom. Pine, Redwood, Oak or recycled plastic
- Shipped assembled
- Sizes: 22 or 32 gallon



Model 5424  
32 gallon  
Round Litter  
in Redwood,  
Portable.  
Shown  
with Model  
5475 plastic  
dome.

Model 5427 22 gallon Round Litter  
in Redwood, In-ground. Shown with  
Model 5480 metal dome.



## Series 5600 Swing Litter

- Swing-out design
- Available in Pine, Redwood and Oak
- Shipped assembled
- Galvanized Liner
- Size: 30 Gallon



Optional Model 5612  
galvanized liner  
with handles

Model 5608  
30 gallon Swing Litter in Oak



## Series 5700 Heavy Litter

- Heavy Duty 2"X4" slats
- Available in Pine, Redwood, Oak or recycled plastic
- Portable or In-ground
- Size: 22 or 32 gallon
- Optional galvanized liner
- Polyurethane finish available

Model 5750 32 gallon Heavy Litter  
in Redwood, In-ground



## Series 5800 40-Slat Litter

- 1" X 1" slats
- Available in Pine, Redwood and Oak
- Portable or In-ground
- Size: 22 Gallon

Model 5822 22 gallon 40-Slat Litter  
in Pine shown with Model 9110  
galvanized can with lid (20 gallon)



# EARTHCARE SERIES RECYCLED FURNISHINGS

## Earthcare Series Recycled Plastic Colors



Brown



Redwood



Cedar



Weathered



Dark Gray



White



Gray



Norwegian



Hunter Green



Oak



California Redwood



Model 4290 Rustic Saddle Seat, 8-seat, 54" diameter



Model 4345 3' Square American Table without backs



Model 5330 Square Litter (shown in Brown)

Nominal sizes available are:



2"X4"

3"X4"

4"X4"

6"X6"

2"X10"

Check with factory for color availability. Printed colors may not match actual colors. Contact factory for color chip.

## "Elegance in Recycled Plastic"

Litchfield is proud to offer an environmentally-friendly option for our most popular site furnishings. Made of 100% post-consumer plastic, with no industrial waste or other filler added, the Earthcare Recycled Plastic replaces wood components on benches, tables, litter receptacles, planters, bike racks and bollards, and makes up our Series 9900 speed bumps and parking stops.

Earthcare Recycled Plastic is available in a number of attractive colors, which maintain an aesthetically pleasing appearance without finishing.



Model 4409 6' Portable Mountaineer Table with 4"X6" slats



Model 3281 6' Landscape Bench with back, gull leg and 4" X 4" slats



Model 5433 32 Gallon Portable Round Litter with 2"X4" Slats (Shown with Model 5475 plastic dome)



Model 3106 6' Liberty Bench with 2"X4" slats



Model 3106 6' Liberty Bench with 2"X4" slats



Model 9526 6' Long Rustic Table with 2"X10" slats and 2-3/8" galvanized frame



Model 3908 8' Rustic Bench with Posts



Model 4430 6' "Little Seats" Mountaineer Table

(800) 542-5282



# SURVIVOR SERIES FURNISHINGS

## Regal Series

The Regal Series tables and benches feature tops and seats made with 3/4" #9 expanded metal. They are welded inside a strong 2" X 2" angle iron frame

with a protective plastisol coating. Additional bracing under the frames uses 1 1/2" X 1/4" flat steel which is important to keep the rounded corners and frame edges straight and good looking over years of hard abuse.



T46RC-3



T46RC



T46OCT



T8RCHDCPALT



T8RC



T8RCHDCP



B6RCP



B6WBRC



Black



Clay  
(Almond Frame)



Yellow



Orange



Red



Burgundy



Brown



Mariner Blue



Purple



Green

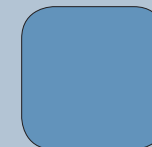

Blue



Teal

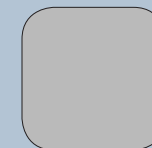

Gray



White

## Regal Portable Tables

Description	Item #	Weight	Retail
46" Square w/4 Seats	T46RC	253lbs. (94.4kg)	\$554
46" Square w/3 Seats	T46RC-3	233lbs. (87.0kg)	\$615
46" Square w/2 Seats	T46RC-2	213lbs. (79.5kg)	\$613
46" Octagonal w/4 Seats	T46OCT	253lbs. (94.4kg)	\$543
6' Rectangular	T6RC	217lbs. (81.0kg)	\$496
8' Rectangular	T8RC	280lbs. (104.5kg)	\$553
8' Rectangular ADA Offset	T8RCHDCP	238lbs. (88.8kg)	\$530
8' Rectangular ADA Centered	T8RCHDCPALT	238lbs. (88.8kg)	\$530

## Regal Benches

In-Ground, Surface Mount and Portable Available

Description	Item #	Weight	Retail
6' Bench w/Back	B6WBRC	113lbs. (42.2kg)	\$277
6' Bench w/o Back	B6RC	42lbs. (15.7kg)	\$160
8' Bench w/Back	B8WBRC	170lbs. (63.4kg)	\$309
8' Bench w/o Back	B8RC	81lbs. (30.2kg)	\$179

With 14 available colors to choose from for tops, seats and frames you can coordinate your amenities to your shelter color(s).

# SURVIVOR SERIES FURNISHINGS

## Regal Series



T46RCPED-2SM



T6RCPEDS

### Regal Pedestal Tables

In-Ground and Surface Mount Available

Description	Item #	Weight	Retail
46" Square w/4 Seats	T46RCPED	361lbs. (134.7kg)	\$675
46" Square w/3 Seats	T46RCPED-3	305lbs. (113.8kg)	\$664
46" Square w/2 Seats	T46RCPED-2	249lbs. (92.9kg)	\$589
6' Rectangular	T6RCPED	296lbs. (296kg)	\$644
8' Double Pedestal Rectangular	T8RCDBLPED	400lbs. (149.3kg)	\$942



46RCPEDS



T8RCDBLPEDSM

## Canteen Series

Our Canteen Series tables and benches feature tops and seats made with 3/4" #9 expanded metal. They are welded inside a strong 2" X 2" angle iron frame with a protective plastisol coating. Additional bracing under the frames uses 1 1/2" X 1/4" flat steel which is important to keep the rounded corners and frame edges straight and good looking over years of hard abuse. These tables are perfect for food courts and courtyards.



T46RACPEDS



T46RACS

### Canteen Pedestal Tables

In-Ground and Surface Mount Available

Description	Item #	Weight	Retail
46" Round w/4 Seats	T46RACSPED	298lbs. (111.2kg)	\$708
46" Round w/3 Seats	T46RACSPED-3	288lbs. (107.5kg)	\$665
46" Round w/2 Seats	T46RACSPED-2	268lbs. (100.0kg)	\$645

### Canteen Portable Tables

Description	Item #	Weight	Retail
46" Round w/4 Seats	T46RACS	239lbs. (89.2kg)	\$574
46" Round w/3 Seats	T46RACS-3	229lbs. (85.5kg)	\$548
46" Round w/2 Seats	T46RACS-2	219lbs. (81.7kg)	\$491

# SURVIVOR SERIES FURNISHINGS

## Innovated Style Tables & Benches



T46INNVPEDS



T46INNV



T6INNV



T46INNVPEDSM



B6INNBVSM



B6WBINNVSM  
shown with SMSCOVER

The Innovated Style Series features a small hole size which creates a smoother surface. This design using small hole 11 gauge punched steel holes is equal to or will exceed the load bearing capacities of 3/4" #9 gauge expanded metal.

### Innovated Style Portable Tables

Description	Item #	Weight	Retail
46" Octagonal w/4 Seats	T46INNV	266lbs. (99.3kg)	\$622
46" Octagonal w/3 Seats	T46INNV-3	246lbs. (91.8kg)	\$686
46" Octagonal w/2 Seats	T46INNV-2	226lbs. (84.3kg)	\$643
6' Rectangular	T6INNV	223lbs. (83.2kg)	\$612
8' Rectangular	T8INNV	282lbs. (105.2kg)	\$687
8' Rectangular ADA Offset	T8INNVHDCP	278lbs. (103.7kg)	\$666
8' Rectangular ADA Centered	T8INNVHDCPALT	278lbs. (103.7kg)	\$666

### Innovated Style Pedestal Tables

In-Ground and Surface Mount Available

Description	Item #	Weight	Retail
46" Octagonal w/4 Seats	T46INNVPED	335lbs. (125.0kg)	\$772
46" Octagonal w/3 Seats	T46INNVPED-3	320lbs. (119.4kg)	\$753
46" Octagonal w/2 Seats	T46INNVPED-2	300lbs. (112.0kg)	\$641
6' Rectangular	T6INNVPED	311lbs. (116.1kg)	\$692
8' Double Pedestal Rectangular	T8INNVDBLPED	415lbs. (154.9kg)	\$984

### Innovated Style Benches

In-Ground, Surface Mount and Portable Available

Description	Item #	Weight	Retail
6' Bench w/Back	B6WBINNV	144lbs. (53.7kg)	\$309
6' Bench w/o Back	B6INNV	74lbs. (27.6kg)	\$197
8' Bench w/Back	B8WBINNV	183lbs. (68.3kg)	\$344
8' Bench w/o Back	B8INNV	92lbs. (34.3kg)	\$213

## SURVIVOR SERIES FURNISHINGS

### In.nity Style Portable Tables

Description	Item #	Weight	Retail
46" Square w/4 Seats	T46INF	253lbs. (94.4kg)	\$571
46" Square w/3 Seats	T46INF-3	233lbs. (87.0kg)	\$631
46" Square w/2 Seats	T46INF-2	213lbs. (79.5kg)	\$629
6' Rectangular	T6INF	217lbs. (81.0kg)	\$512
8' Rectangular	T8INF	280lbs. (104.5kg)	\$570
8' Rectangular ADA Offset	T8INFHDCP	238lbs. (88.8kg)	\$547
8' Rectangular ADA Centered	T8INFHDCPALT	238lbs. (88.8kg)	\$547

### In.nity Style Pedestal Tables

In-Ground and Surface Mount Available

Description	Item #	Weight	Retail
46" Square w/4 Seats	T46INFPED	361lbs. (134.7kg)	\$696
46" Square w/3 Seats	T46INFPED-3	305lbs. (113.8kg)	\$682
46" Square w/2 Seats	T46INFPED-2	249lbs. (92.9kg)	\$604
6' Rectangular	T6INFPED	217lbs. (81.0kg)	\$512
8' Double Pedestal Rectangular	T8INFDBLPED	280lbs. (104.5kg)	\$570

### Infinity Style Benches

In-Ground, Surface Mount and Portable Available

Description	Item #	Weight	Retail
6' Bench w/Back	B6WBINF	113lbs. (42.2kg)	\$285
6' Bench w/o Back	B6INF	42lbs. (15.7kg)	\$165
8' Bench w/Back	B8WBINF	170lbs. (63.4kg)	\$318
8' Bench w/o Back	B8INF	81lbs. (30.2kg)	\$184



B6WBINF



B6INF



T46INF



T6INF



T46INFPED



T6INFPED

### In.nity Style Tables & Benches

Our Infinity Style benches and tables feature tops and seats made with 3/4" #9 expanded metal welded inside a strong 2" x 2" angle iron frame with a protective plastisol coating. The seats have the same sturdy 2" border, but with an angled sloping design that give the table a unique look. Additional bracing under the frames uses 1 1/2" x 1/4" flat steel which keep the rounded corners and frames straight and good looking over years of hard abuse.



T8INFHDCPALT



T8INFHDCPALT

(800) 542-5282

# SURVIVOR SERIES FURNISHINGS

## Infinity Innovated Style Tables & Benches



T46INFINNV



T6INFINNVPEDS



T6INFINNV



T46INFINNVPEDS



B6WBINFINNV

Our Infinity Innovated tables and benches feature tops and seats made with small hole 11 gauge punched steel welded inside a strong 2" x 2" angle iron frame with a protective plastisol coating. The tops and seats still have the same sturdy 2" border, but with an angled sloping design that gives the table a whole new look. Additional bracing under the frames uses 1 1/2" x 1/4" . at steel which is important to keep the product straight and good looking over years of hard abuse.

### Infinity Innovated Portable Tables

Description	Item #	Weight	Retail
46" Octagonal w/4 Seats	T46INFINNV	266lbs. (99.3kg)	\$641
46" Octagonal w/3 Seats	T46INFINNV-3	246lbs. (91.8kg)	\$705
46" Octagonal w/2 Seats	T46INFINNV-2	226lbs. (84.3kg)	\$660
6' Rectangular	T6INFINNV	223lbs. (83.2kg)	\$631
8' Rectangular	T8INFINNV	282lbs. (105.2kg)	\$708
8' Rectangular ADA Offset	T8INFINNVHDCP	278lbs. (103.7kg)	\$686
8' Rectangular ADA Centered	T8INFINNVHDCPALT	278lbs. (103.7kg)	\$686

### Infinity Innovated Pedestal Tables

In-Ground and Surface Mount Available

Description	Item #	Weight	Retail
46" Octagonal w/4 Seats	T46INFINNVPED	335lbs. (125.0kg)	\$796
46" Octagonal w/3 Seats	T46INFINNVPED-3	320lbs. (119.4kg)	\$775
46" Octagonal w/2 Seats	T46INFINNVPED-2	300lbs. (112.0kg)	\$659
6' Rectangular	T6INFINNVPED	311lbs. (116.1kg)	\$714
8' Double Pedestal Rectangular	T8INFINNVDBLPED	415lbs. (154.9kg)	\$1,014

### Infinity Innovated Benches

In-Ground, Surface Mount and Portable Available

Description	Item #	Weight	Retail
6' Bench w/Back	B6WBINFINNV	144lbs. (53.7kg)	\$318
6' Bench w/o Back	B6INFINNV	74lbs. (27.6kg)	\$203
8' Bench w/Back	B8WBINFINNV	183lbs. (68.3kg)	\$355
8' Bench w/o Back	B8INFINNV	92lbs. (34.3kg)	\$220

## SURVIVOR SERIES FURNISHINGS

### Perforated Style Portable Tables

Description	Item #	Weight	Retail
46" Square w/4 Seats	T46PERF	305lbs. (113.8kg)	\$641
46" Square w/3 Seats	T46PERF-3	285lbs. (106.4kg)	\$705
46" Square w/2 Seats	T46PERF-2	265lbs. (98.9kg)	\$660
6' Rectangular	T6PERF	235lbs. (87.7kg)	\$587
8' Rectangular	T8PERF	323lbs. (120.5kg)	\$667
8' Rectangular ADA Offset	T8PERFHDCP	294lbs. (109.7kg)	\$641
8' Rectangular ADA Centered	T8PERFHDCPALT	294lbs. (109.7kg)	\$641

### Perforated Style Pedestal Tables

In-Ground and Surface Mount Available

Description	Item #	Weight	Retail
46" Square w/4 Seats	T46PERFPED	413lbs. (154.1kg)	\$772
46" Square w/3 Seats	T46PERFPED-3	393lbs. (146.7kg)	\$753
46" Square w/2 Seats	T46PERFPED-2	373lbs. (139.2kg)	\$733
6' Rectangular	T6PERFPED	314lbs. (117.2kg)	\$856
8' Double Pedestal Rectangular	T8PERFDBLPED	425lbs. (158.6kg)	\$1,035

### Perforated Style Benches

In-Ground, Surface Mount and Portable Available

Description	Item #	Weight	Retail
6' Bench w/Back	B6WBPERF	149lbs. (55.6kg)	\$335
6' Bench w/o Back	B6PERF	89lbs. (33.2kg)	\$284
8' Bench w/Back	B8WBPERF	168lbs. (62.7kg)	\$386
8' Bench w/o Back	B8PERF	104lbs. (40.3kg)	\$300



B8WBPERFP

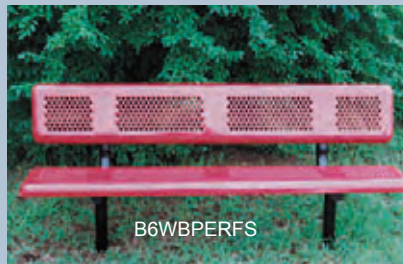

B6WBPERFS

### Perforated Style Tables & Benches

The unique hole pattern of the Perforated Style tables & benches provides a very smooth surface. Tops and seats are made with plastisol coated large hole #11 punched steel and given extra support with 1 1/2" X 1/4" flat steel. All edges and corners are rounded to a 2" radius.



T46PERF



T6PERF



T8PERFHDCP



T46PERFPEDS



T6PERFPEDS

(800) 542-5282

# SURVIVOR SERIES FURNISHINGS

## Web Style Tables & Benches

Web Style tables & benches offer ease of access to seating and convenience of clean up beneath. This series of tables also allows your imagination to run wild with the wide selection of patterns for the tops and seats. The 2 7/8" OD easy access frames add strength and durability. Mounting plates are standard and can be either bolted down to concrete for surface mounting application or left un-bolted for portable applications. Stationary frames for inground mounting are also available. The stationary models have an extra 30" length on the frame legs to allow for inground mounting applications. Solid cast aluminum surface mount covers (SMLCOVER) are available at an additional cost for that final finished look, see page 70.



T46WEBRACSPSM shown with SMLCOVER



T46WEBINNVS



T46WEBINNVPSM shown w/ SMLCOVER



T9WEBINNVPSM shown with SMLCOVER

### Web Style Round Tables

In-Ground (IG) and Surface Mount/Portable (SM) Available

Description	Item #	Weight	Retail
46" Round w/4 Seats	T46WEBRACSPSM (SM) T46WEBRACSS (IG)	255lbs. (95.2kg) 268lbs. (100.0kg)	\$678 \$738
46" Round w/3 Seats	T46WEBRACS-3SM (SM) T46WEBRACS-3S (IG)	213lbs. (79.5kg) 232lbs. (86.6kg)	\$588 \$632
46" Round w/2 Seats	T46WEBRACS-2SM T46WEBRACS-2S	171lbs. (63.8kg) 184lbs. (68.7kg)	\$514 \$559

### Web Style Infinity Tables

In-Ground (IG) and Surface Mount/Portable (SM) Available

Description	Item #	Weight	Retail
46" Square w/4 Seats	T46WEBINFPSM (SM) T46WEBINF (IG)	284lbs. (106.0kg) 303lbs. (113.1kg)	\$593 \$655
46" Square w/3 Seats	T46WEBINF-3SM (SM) T46WEBINF-3S (IG)	241lbs. (89.9kg) 254lbs. (94.8kg)	\$631 \$694
46" Square w/2 Seats	T46WEBINF-2SM (SM) T46WEBINF-2S (IG)	198lbs. (73.9kg) 211lbs. (78.7kg)	\$588 \$639
9' Rectangular w/2 4' Seats & w/1 9' Seat	T9WEBINFPSM (SM) T9WEBINF (IG)	323lbs. (120.5kg) 360lbs. (134.4kg)	\$896 \$951
9' Rectangular w/2 3' Seats & w/1 9' Seat	T9WEBINFHDCPPSM (SM) T46WEBINFHDCPS (IG)	311lbs. (116.1kg) 348lbs. (129.9kg)	\$896 \$951

### Web Style Innovated Tables

In-Ground (IG) and Surface Mount/Portable (SM) Available

Description	Item #	Weight	Retail
46" Octagon w/4 Seats	T46WEBINNVPSM (SM) T46WEBINNVS (IG)	300lbs. (112.0kg) 319lbs. (119.1kg)	\$725 \$780
46" Octagon w/3 Seats	T46WEBINNV-3SM (SM) T46WEBINNV-3S (IG)	255lbs. (95.2kg) 275lbs. (102.6kg)	\$765 \$819
46" Octagon w/2 Seats	T46WEBINNV-2SM (SM)	210lbs. (78.4kg)	\$722
9' Rectangular w/2 4' Seats & w/1 9' Seat	T9WEBINNVPSM (SM) T9WEBINNVS (IG)	349lbs. (130.2kg) 386lbs. (144.1kg)	\$936 \$1,007
9' Rectangular w/2 3' Seats & w/1 9' Seat	T9WEBINNVHDCPPSM (SM) T46WEBINNVHDCPS (IG)	335lbs. (125.0kg) 372lbs. (138.8kg)	\$936 \$1,007



## SURVIVOR SERIES FURNISHINGS

### Web Style Square Tables

In-Ground (IG) and Surface Mount/Portable (SM) Available

Description	Item #	Weight	Retail
46" Square w/4 Seats	T46WEBPSM (SM) T46WEBS (IG)	284lbs. (106.0kg) 303lbs. (113.1kg)	\$612 \$671
46" Square w/3 Seats	T46WEB-3SM (SM) T46WEB-3S (IG)	241lbs. (89.9kg) 254lbs. (94.8kg)	\$615 \$676
46" Square w/2 Seats	T46WEB-2SM (SM) T46WEB-2S (IG)	198lbs. (73.9kg) 211lbs. (78.7kg)	\$572 \$623
9' Rectangular w/2 4' Seats & w/1 9' Seat	T9WEBPSM (SM) T9WEBS (IG)	323lbs. (120.5kg) 360lbs. (134.4kg)	\$905 \$959
9' Rectangular w/2 3' Seats & w/1 9' Seat	T9WEBHDCPPSM (SM) T9WEBHDCPS (IG)	311lbs. (116.1kg) 348lbs. (129.9kg)	\$905 \$959

### Web Style Infinity Tables

In-Ground (IG) and Surface Mount/Portable (SM) Available

Description	Item #	Weight	Retail
46" Square w/4 Seats	T46WEBINFPSM (SM) T46WEBINF (IG)	284lbs. (106.0kg) 303lbs. (113.1kg)	\$593 \$655
46" Square w/3 Seats	T46WEBINF-3SM (SM) T46WEBINF-3S (IG)	241lbs. (89.9kg) 254lbs. (94.8kg)	\$631 \$694
46" Square w/2 Seats	T46WEBINF-2SM (SM) T46WEBINF-2S (IG)	198lbs. (73.9kg) 211lbs. (78.7kg)	\$588 \$639
9' Rectangular w/2 4' Seats & w/1 9' Seat	T9WEBINFPSM (SM) T9WEBINF (IG)	323lbs. (120.5kg) 360lbs. (134.4kg)	\$896 \$951
9' Rectangular w/2 3' Seats & w/1 9' Seat	T9WEBINFHDCPPSM (SM) T46WEBINFHDCPS (IG)	311lbs. (116.1kg) 348lbs. (129.9kg)	\$896 \$951

### Web Style Square Perforated Tables

In-Ground (IG) and Surface Mount/Portable (SM) Available

Description	Item #	Weight	Retail
46" Square w/4 Seats	T46WEBPERFPSM (SM) T46WEBPERF (IG)	334lbs. (124.6kg) 283lbs. (105.6kg)	\$737 \$791
46" Square w/3 Seats	T46WEBPERF-3SM (SM) T46WEBPERF-3S (IG)	302lbs. (112.7kg) 353lbs. (131.7kg)	\$694 \$749
46" Square w/2 Seats	T46WEBPERF-2SM (SM) T46WEBPERF-2S (IG)	232lbs. (86.6kg) 251lbs. (93.7kg)	\$652 \$706

### More Web Style Tables & Benches



T9WEBHDCPS



T46WEBPSM shown with SMLCOVER



T46WEB-3S



T46WEBPERFPSM

### Web Style Infinity Innovated Tables

In-Ground (IG) and Surface Mount/Portable (SM) Available

Description	Item #	Weight	Retail
46" Square w/4 Seats	T46WEBFINNVPSM (SM) T46WEBFINNV (IG)	300lbs. (112.0kg) 319lbs. (119.1kg)	\$748 \$804
46" Square w/3 Seats	T46WEBFINNV-3SM (SM) T46WEBFINNV-3S (IG)	255lbs. (95.2kg) 275lbs. (102.6kg)	\$786 \$842
46" Square w/2 Seats	T46WEBFINNV-2SM (SM) T46WEBFINNV-2S (IG)	210lbs. (78.4kg) 229lbs. (85.5kg)	\$742 \$799
9' Rectangular w/2 4' Seats & w/1 9' Seat	T9WEBFINNVPSM (SM) T9WEBFINNV (IG)	349lbs. (120.5kg) 386lbs. (134.4kg)	\$928 \$1,001
9' Rectangular w/2 3' Seats & w/1 9' Seat	T9WEBFINNVHDCPPSM (SM) T46WEBFINNVHDCPS (IG)	335lbs. (125.0kg) 372lbs. (138.8kg)	\$928 \$1,001



T46WEBFINNVPSM shown with SMLCOVER

# SURVIVOR SERIES FURNISHINGS

## Classic Style Benches

Classic Style benches use cast aluminum frames combined with a ribbed steel back and seat. "-ADDON" indicates an extension consisting of one additional frame/armrest and one seat.

Classic Style models are Surface Mount and/or Portable

Description	Item #	Weight	Retail
4' Bench	B4WBCLASSIC	98lbs. (36.6kg)	\$604
4' Bench Extension	B4WBCLASSIC -ADDON	86lbs. (32.1kg)	\$392
6' Bench	B6WBCLASSIC	122lbs. (45.5kg)	\$703
6' Bench Extension	B6WBCLASSIC -ADDON	110lbs. (41.1kg)	\$561



B6WBCLASSIC



B6WBCLASSIC-ADDON

## Classic Casino Style Benches

The Classic Casino Style benches bring the look of the old world and new world together with the vintage ribbed look combined with the new frame made from 12 gauge 1 1/2" galvanized tubing with a powder coat finish. See page 70 for additional arm rests.

Surface Mount and Portable Available

Description	Item #	Weight	Retail
4' Bench	B4WBCLASSCASINO	95lbs. (35.5kg)	\$604
6' Bench	B6WBCLASSCASINO	118lbs. (44.0kg)	\$676



B4WBCLASSCASINO

## Modern Casino Style Benches

The Modern Casino Style benches combine the comfortable contour seat with a stylish new frame made from 12 gauge 1 1/2" galvanized tubing with a powder coat finish. See page 70 for additional arm rests.

Surface Mount and Portable Available

Description	Item #	Weight	Retail
4' Bench	B4WBMODCASINO	115lbs. (42.9kg)	\$479
6' Bench	B6WBMODCASINO	135lbs. (50.4kg)	\$603



B6WBMODCASINO



B6WBMODCASINO

# SURVIVOR SERIES FURNISHINGS

## Villa Style Benches

Our Villa Style benches have a refined new look. The back and seats are made with #9 gauge 3/4" expanded metal with a larger diamond design in the middle for added style. "-ADDON" indicates an extension consisting of one additional frame/armrest and one seat.

Villa Style models are Surface Mount and/or Portable

Description	Item #	Weight	Retail
4' Bench	B4WBVILLAEXP	93lbs. (34.7kg)	\$510
4' Bench Extension	B4WBVILLAEXP -ADDON	71lbs. (26.5kg)	\$390
6' Bench	B6WBVILLAEXP	140lbs. (52.2kg)	\$645
6' Bench Extension	B6WBVILLAEXP -ADDON	138lbs. (51.5kg)	\$525



B6WBVILLAEXP



B4WBVILLAEXP-ADDON

## Villa Casino Style Benches

Villa Casino Style benches, like the Modern Casino Style use the same contoured seat but with a large diamond decorative border with the same stylish new frame made from 12 gauge 1 1/2" galvanized tubing with a powder coat finish. See page 70 for additional arm rests.

Surface Mount and Portable Available

Description	Item #	Weight	Retail
4' Bench	B4WBVILLACASINO	86lbs. (32.1kg)	\$510
6' Bench	B6WBVILLACASINO	135lbs. (50.4kg)	\$645

## Wingline Style Benches

The Wingline Style benches are made from 3/4" #9 gauge expanded metal and 2 7/8" legs. With a contoured seat and arms for maximum comfort. The Wingline Style is also available with a Classic Style slotted seat.

In-Ground, Surface Mount and Portable Available

Description	Item #	Weight	Retail
4' Bench w/Back	B4WBWINGLINE	106lbs. (39.6kg)	\$298
6' Bench w/Back	B6WBWINGLINE	121lbs. (45.2kg)	\$395
4' Bench w/Back	B4WBCLASSICWINGLINE	131lbs. (48.9kg)	\$351
6' Bench w/Back	B6WBCLASSICWINGLINE	174lbs. (64.9kg)	\$411



B6WBWINGLINESM shown w/ SMLCOVER



B4WBCLASSICWINGLINESM shown with SMLCOVER



B4WBVILLACASINO



B6WBVILLACASINO w/ ARM (2)

(800) 542-5282

# SURVIVOR SERIES FURNISHINGS

## Modern Style Benches



B6WBMODERNPSM shown w/ SMLCOVER



B4MODERNPSM



W-B4WBMODERNPSM-ADDON



B6WBMODCLASSPSM



B6MODCLASSPSM

Modern Style benches use a special bent frame of 2 7/8" tubing. Modern Style benches can be used with a choice of contoured seats including expanded metal and ribbed steel. "-ADDON" indicates an extension consisting of one additional frame/armrest and one seat.

### Modern Style Benches

In-Ground, Surface Mount and Portable Available

Description	Item #	Weight	Retail
4' Bench w/Back	B4WBMODERN	120lbs. (44.8kg)	\$431
4' Bench w/Back Extension	(B4WBMODERN) -ADDON	105lbs. (39.2kg)	\$399
4' Bench w/o Back	B4MODERN	95lbs. (35.5kg)	\$410
4' Bench w/o Back Extension	(B4MODERN) -ADDON	80lbs. (29.9kg)	\$335
6' Bench w/Back	B6WBMODERN	140lbs. (52.2kg)	\$532
6' Bench w/Back Extension	(B6WBMODERN) -ADDON	125lbs. (46.7kg)	\$501
6' Bench w/o Back	B6MODERN	120lbs. (44.8kg)	\$458
6' Bench w/o Back Extension	(B6MODERN) -ADDON	80lbs. (29.9kg)	\$426

### Modern Classic Benches

In-Ground, Surface Mount and Portable Available

Description	Item #	Weight	Retail
4' Bench w/Back	B4WBMODCLASS	110lbs. (41.1kg)	\$516
4' Bench w/Back Extension	(B4WBMODCLASS) -ADDON	95lbs. (35.5kg)	\$483
4' Bench w/o Back	B4MODCLASS	100lbs. (37.3kg)	\$468
4' Bench w/o Back Extension	(B4MODCLASS) -ADDON	85lbs. (31.7kg)	\$436
6' Bench w/Back	B6WBMODCLASS	230lbs. (85.8kg)	\$595
6' Bench w/Back Extension	(B6WBMODCLASS) -ADDON	215lbs. (80.2kg)	\$563
6' Bench w/o Back	B6MODCLASS	124lbs. (46.3kg)	\$532
6' Bench w/o Back Extension	(B6MODCLASS) -ADDON	109lbs. (40.7kg)	\$501

# SURVIVOR SERIES FURNISHINGS

## Downtown Style Benches

In-Ground, Surface Mount and Portable Available

Description	Item #	Weight	Retail
3 Seat Concave w/Back	BWBDTCCV	158lbs. (59.0kg)	\$676
3 Seat Concave w/o Back	BDTCCV	150lbs. (56.0kg)	\$687
3 Seat Convex w/Back	BWBDTCVX	135lbs. (50.4kg)	\$676
3 Seat Convex w/o Back	BDTCVX	120lbs. (44.8kg)	\$687
3 Seat Straight w/Back	BWBDS3	160lbs. (59.7kg)	\$687
3 Seat Straight w/o Back	BDTS3	150lbs. (56.0kg)	\$600
2 Seat Straight w/Back	BWBDS2	125lbs. (46.7kg)	\$463
2 Seat Straight w/o Back	BDTS2	125lbs. (46.7kg)	\$381



BWBDS2S



BDTCCVSM

## Downtown Style Benches

Our Downtown Style benches are available in either two or three-seat configurations in a straight line or as three seaters in curved configurations. The curved models have the option of concave curve or convex curve. The selection offers flexibility in setting up different layouts. Available with or without backs.



BWBDS3SM



BWBDTCCVSM



BWBDTCVXSM

## Accessories

Benches and Tables

Description	Item #	Weight	Retail
Surface Mount Cover for 2 7/8" Tubing (set of 2)	SMLCOVER	2lbs. (.7kg)	\$34
Surface Mount Cover for 2 3/8" Tubing (set of 2)	SMSCOVER	2lbs. (.7kg)	\$34
Center Arm Rest for Bench	ARM	5lbs. (1.9kg)	\$49



SMLCOVER

## Bench and Table Accessories

These accessories are for many of our tables and benches. The Surface Mount Covers are for surface mounted tables and benches with either 2 3/8" tubing or 2 7/8" tubing. The Center Arm Rest adds an additional arm rest to your Modern Casino, Classic Casino, or Villa Casino Bench.



ARM on Modern Casino



ARM on Villa Casino



ARM on Classic Casino

# SURVIVOR SERIES FURNISHINGS

## Trash Receptacles

Our Trash Receptacles are available in many styles to complement all of our bench styles. There is also a wide variety of accessories to work in conjunction with our trash receptacles to keep your seating and eating areas clean and looking good. Receptacles do not include Liner, Lid, mount or Ash Urn, these items are found on this and the next page.

### Trash Receptacle

Lids, Stands, Liners and Ash Urns Not Included.

Description	Item #	Weight	Retail
Standard 55 Gallon	TR 55	120lbs. (44.8kg)	\$192
Standard 32 Gallon	TR 32	70lbs. (26.1kg)	\$170
Standard 22 Gallon	TR 22	45lbs. (16.8kg)	\$149
Honeycomb 32 Gallon	TR 32 PERF	75lbs. (28.0kg)	\$240
Honeycomb 22 Gallon	TR 22 PERF	50lbs. (18.7kg)	\$208
Boulevard Honeycomb 32 Gallon	TR32 AVENUEPERF	75lbs. (28.0kg)	\$307
Boulevard Honeycomb 22 Gallon	TR22 AVENUEPERF	55lbs. (20.5kg)	\$296
Boulevard 32 Gallon	TR32 AVENUEEXP	75lbs. (28.0kg)	\$296
Boulevard 22 Gallon	TR22 AVENUEEXP	55lbs. (20.5kg)	\$285
Vintage 32 Gallon	TR 32 CLASSIC	75lbs. (28.0kg)	\$291
Vintage 22 Gallon	TR 22 CLASSIC	50lbs. (18.7kg)	\$291
Taper 32 Gallon	TR 32 TAPER	78lbs. (29.1kg)	\$178
Vintage Taper 32 Gallon	TR 32 CLASSIC TAPER	100lbs. (37.3kg)	\$304

### Trash Receptacle Liners

Available in colors shown

Description	Item #	Weight	Retail
Rigid Plastic Liner for TR 55	LINER 55	20lbs. (7.5kg)	\$87
Rigid Plastic Liner for TR 35	LINER 32	5lbs. (1.9kg)	\$21
Rigid Plastic Liner for TR 25	LINER 22	4lbs. (1.5kg)	\$16

### Trash Receptacle Inground and Surface Mounts

Specify 55Gal, 32Gal, 32Gal TAPER or 22Gal

Description	Item #	Weight	Retail
Inground Mount	TR ING	10lbs. (3.7kg)	\$31
Surface Mount	TR SM	10lbs. (3.7kg)	\$31



TR 55



TR AVEEXP



TR 32 TAPER



TR 22 CLASSIC



TR 32 PERF



TR 32 CLASSIC TAPER

## Trash Receptacle Liners

We have Trash Receptacle Liners for TR 55, TR 32 and TR 22 model receptacles. Available in colors shown.



BLACK

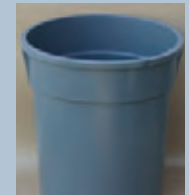

GRAY



BLUE



RED



YELLOW

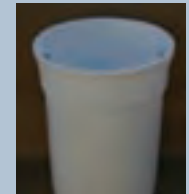

WHITE



TR SM-32



TR ING-32

# SURVIVOR SERIES FURNISHINGS

## Trash Receptacle Lids

Available in colors shown for each model

Description	Item #	Weight	Retail
Plastic Dome Top for TR 32	DOME 32	10lbs. (3.7kg)	\$69
Plastic Dome Top for TR 22	DOME 22	8lbs. (3.0kg)	\$67
Steel Dome Top for TR 32	DOME32S	10lbs. (3.7kg)	\$69
Dome Top for TR 55	BIGTOP	35lbs. (13.1kg)	\$311
Flat Top for TR 55	FLATTOP55	35lbs. (13.1kg)	\$64
Flat Top for TR 32	FLATTOP32	20lbs. (7.5kg)	\$64
Flat Top for TR 32 w/16" opening	FLATTOP32-16	20lbs. (7.5kg)	\$64
Flat Top for TR 22	FLATTOP22	17lbs. (6.3kg)	\$64

## Ash Urns

Specify Receptacle Model (Standard, Honeycomb, etc.)

Description	Item #	Weight	Retail
Add-On Ash Urn	ASHATTACH	10lbs. (3.7kg)	\$63

## Pedestal Grill

Inground Mount only

Description	Item #	Weight	Retail
Pedestal Grill 20" Adjustable Grate	GPS20	110lbs. (41.1kg)	\$160



GPS20

## Pedestal Grill

Our classic camp style pedestal grill is the perfect addition to your park. This grill features a 20" adjustable cooking grate. Inground mount only.

## Trash Receptacle Lids

Our Trash Receptacle Lids are available in plastic domes for TR 32 and TR 22 models, steel domes for TR 32 models, flat tops for TR 55, TR 32 and TR 33 models. The big top is available only for TR 55 models. Colors available as shown.



DOME 32 BLUE



DOME 32 BEIGE



DOME 32 RED



DOME 32 BLACK



DOME 32 BROWN



DOME 32 GRAY

## Add-On Ash Urns



ASHATTACH on Boulevard



ASHATTACH on Honeycomb



DOME 32S GREEN



DOME 32S BLUE



DOME 32S BLACK



DOME 32 YELLOW



DOME 32S RED



DOME 32S WHITE



FLATTOP32-16



FLATTOP32



BIGTOP

## Series 9500 Bike Rack

The welded steel rack is supported by massive end posts. Steel has the Litch-Kicker finish. The 8-bike rack is 5' long, and the 14-bike rack is 10' long. Available in single or double sided racks.



Model 9500 10', 14-bike rack with Pine ends and brown enamel steel rack



Left: Model 9547 5' Bike Rack with recycled ends and black steel rack

## Series 9200 Landscape Bollards

Landscape bollards are 5' in length, with 3' exposed. They are available in pressure treated Pine, Redwood or Earthcare Recycled Plastic.



Model 9200 Landscape Bollard in pressure treated Pine

## Series 5200 Mall Planters

The contemporary styling of these handsome planters make them ideal for use in lobbies, meeting places, shopping malls as well as outdoors. Available in Oak, Redwood or Pine. Construction utilizes 2"X4" nominal boards and is available with optional polyurethane coating for indoor use. Furnished with galvanized steel liners for no mess plant upkeep. An 11-gauge steel recessed toe kick is attached to keep wood from contacting the ground.



Model 5288 7' Round Planter in Redwood. Planter height is 30', shipped assembled.



Model 5204 4' Square Planter in Redwood. Planter height is 30', shipped assembled.

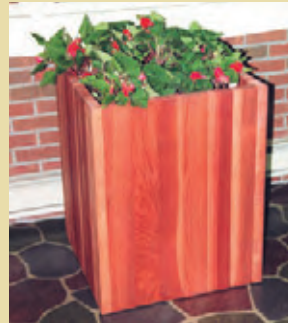

Model 5203 2' Square Planter in Redwood. Planter height is 30', shipped assembled.

All are available in many custom sizes and different wood choices, including recycled plastic!

## Series 9900 Parking Stop

Earthcare Recycled Plastic in 3', 4' & 6' lengths in colors shown below.



## Series 9900 Speed Bump

4', 6' or 9' lengths of Earthcare Recycled Plastic in yellow.

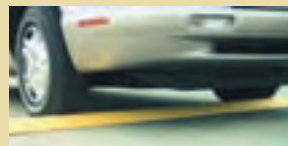

## Series 9600 Grills

The grills are fabricated with 7-gauge steel plate, finished with a non-toxic enamel. Surface mount and single post in-ground available.



Model 9605 Double Pedestal Grill



Model 9604 Campfire Ring



Model 9601 Campfire Adjustable Grill

## Series 9100 Trash Can Rest

The Series 9100 Trash Can Rest keeps refuse "off limits" to animals. The direct bury post is constructed of pressure treated Pine with steel attachments.



Model 9100 treated Pine Trash Can Rest with 2 Model 9110 30 gallon galvanized cans

## Series 5400 Litter Tops

Litter tops are available in metal or plastic, in flat or dome style.



Model 5475 32 Gallon only Plastic Dome Top with self-closing door



Model 5470 32 Gallon only flat plastic top with rotating lid



Model 5480 22 Gallon only Metal Dome Top with self-closing door. Available in brown or white.



## Ornamental Lattice and Handrails

Litchfield Landscape Elements offers a variety of standard and custom laser-cut patterns for steel handrails and lattice. Select from the styles shown here, or send us a pattern of your design for custom fabrication.



Standard Pattern

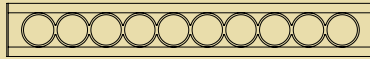

Circle Pattern

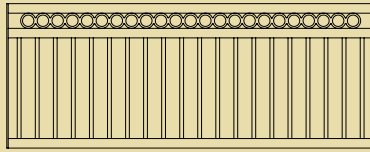
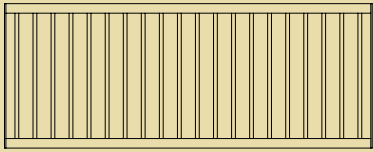

Diamond Pattern

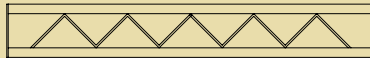

Western Pattern

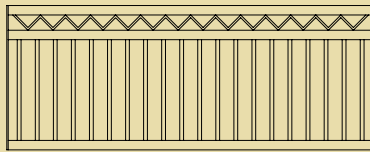
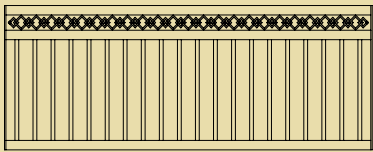

## Ornamental Corner Bracing

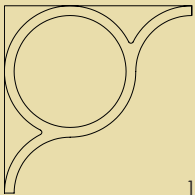

1

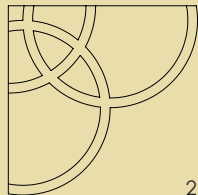

2

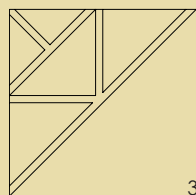

3

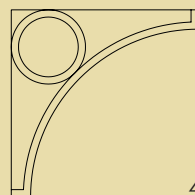

4

## Column Options

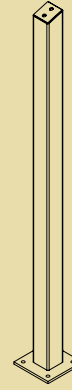

Square  
(Standard Pattern)



Round

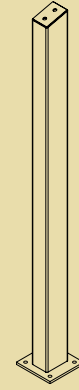

Rectangular



Standard Quad

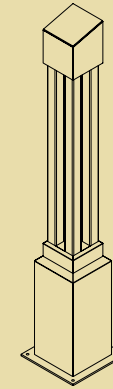

Premium Quad

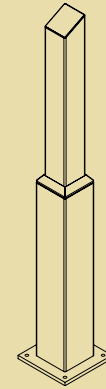

Stepped

Optional architectural steel bands are available for Square, Round (with an example of steel bands shown) and Rectangular columns. The location and thickness of the steel bands on the columns can be specified allowing you to further customize your shelter design. Stepped columns are available in steel or laminated wood (on some shelters).

## Series 9300 Cupolas

A variety of cupolas are available for most shelters, in both wood and steel. The size is scaled to fit the shelter you select. Wood cupolas are available in Pine, Western Red Cedar or Redwood. Steel cupola roof colors will match your shelter's metal roof. Many other custom cupolas are available besides what is shown here so please inquire when considering your selection.



Model 9315  
All-Steel Octagonal



Model 9320  
All-Steel Square



Model 9310  
All-Steel Hexagonal



Model 9300  
Wood Hexagonal  
with Copper Cap



Model 9305  
Wood Octagonal  
with Shingles

(Note: Larger shelters require larger cupolas)

## Series 9400 Weathervanes

Handcast aluminum weathervanes with satin black oven-cured enamel finish are 30" high. Ornaments are pewter or gold bronze finish.

Choose from these styles:

Deer, Sailboat, Horse, Country Doctor, Duck, Pheasant, Eagle, Retriever and Rooster

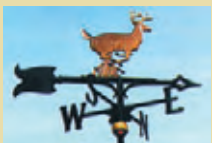

## Perfa-Lite™ Perforated Metal Roofing



Perfa-Lite™ is an All-New alternative to fabric roofing. Perfa-Lite™ blocks up to 44% of harmful UV rays consistently throughout the life of the shelter while allowing plenty of light to shine through for a brighter more pleasant outdoor experience. Perfa-Lite™ utilizes hot rolled steel perforated panels with 3/8" holes at 9/16" staggered centers (custom sizes are available). The material has an 11 gauge minimum thickness with 40% open area and features our "Baked-on" Litch-Kicker finish over an E-coat primer (see Litch-Kicker specifications on page 76). Perfa-Lite's incredibly durable steel panels do not need to be taken down with the change of seasons, require no maintenance and are vandal proof.



Perfa-Lite Perforated Metal Roof Panel

## Optional Metal Finishes

Hot-dipped galvanizing, E-coat primer, and Powder Coat finish are all available at an added cost. Call factory for pricing.

## E-Coat Primer

E-Coat Primer is the result of a process called Electrodeposition coating which uses electricity to deposit a smooth, thin, uniform layer of plastic coating on the surface of a metal part.

Before metal parts receive the E-Coat formula they go through an eight stage state-of-the-art pretreatment process. Each metal part is first cleaned with a powerful combination of spray and dip alkaline cleaners in order to remove dirt, oils, and other contaminants, which can interfere with the development of good paint adhesion or could cause surface defects. Immediately following the cleaning stages, the parts receive a fresh water rinse and an activator salt immersion to improve the next step, phosphate coating. Parts are cleaned and rinsed again, then immersed in a zinc phosphate tank. Zinc phosphate converts the metal substrate to a crystalline surface, creating a good surface for paint bonding and improving corrosion resistance. The part is again rinsed to remove any excess phosphate then immersed in a non-chrome sealer to reduce porosity and prevent flash rusting. The parts are once again rinsed with deionized or reverse osmosis water prior to epoxy coating. After the part has been cleaned and zinc phosphated, it is immersed in liquid epoxy and coated to a smooth and uniform 0.7 - 0.9 mils.

Since the coating is applied as a liquid, the epoxy travels into crevices and trouble spaces to assure that outside moisture cannot invade the coated area and cause rust. The end result of this aggressive pretreatment and E-Coat application is a part that is thoroughly cleaned and fully encapsulated in plastic. The epoxy-coated part is then cured in an oven at approximately 400 degrees Fahrenheit for at least 20 minutes. E-Coat Primer can be expected to withstand 1000 hours or more in a salt spray chamber. These 1000 hours are thought to be approximately equivalent to 10 years of performance.

## Powder Coating

Powder Coating is an additional charge option for

steel components on steel frame shelters. Choose powder coat color(s) by referencing an RAL number listed on an RAL color chart. For an RAL color chart, please contact the factory.

The powder coating process is a complete corrosion protective process. All steel components are cleaned, pretreated, sealed and preheated to assure proper powder thickness and adhesion through a 5 stage, dual zone curing process. The polyester powder is electrostatically applied and oven cured at 375 degrees to a mil thickness of 3.0 - 6.0.

## Wood Finishes

**Walnut Brown Oil Stain** is our own basic oil-base stain that gives wood a deep, rich tone. It is used mostly on Pine, but is available as a finish on other woods.

**Sher-Wood Homoclad Sealer** is a moisture-resistant sealer which protects against rot and discoloration. It penetrates deep into wood pores, increasing dimensional stability. This sealer is used on Southern Yellow Pine, Redwood and Oak.

## Optional Wood Finishes

**Nelsonite** is a wood stabilizer that guards against swelling, shrinking and warping. It repels water, and acts as a preservative. Nelsonite is used on braces and components of truss-type shelters.

**Polyurethane** is a high gloss, clear finish, which highlights wood to a furniture finish. Polyurethane is to be used for indoor furnishings only.

**Sikkens** is a super translucent finish based on special oil-alkyd resin combination and select ultraviolet absorbing pigments. It gives a long-lasting "furniture look" finish.

## Treated Lumber Options

**ACQ (Alkaline Copper Quaternary) Pressure Treated** Southern Yellow Pine provides protection from a broad spectrum of fungi and termites, preventing rot and decay.

**Treated** Southern Yellow Pine with a stabilizer such as a homoclad sealer.

## Available Woods



**Pine.** This wood is strong and sturdy. Both treated and untreated Pine are used in most shelters. Pine is also an economical alternative for benches, tables and

litter receptacles. It stains and finishes well. Note: when pressure treated woods are used, allow for some checking and cracking. This will not affect the strength or integrity of the wood, and will not merit replacement lumber.



**Western Red Cedar.** This species has a reddish tint, and is used in shelters for roof decking and fascia. It is very durable, and is naturally resistant to decay, infestation and checking.



**Oak.** Only number 1 grade Oak is used. Noted for its strength and rich grain, Oak is ideal for indoor benches and site furnishings. Oak is not recommended for outdoor use. Any Oak

furnishings used outdoors will not be covered under warranty.

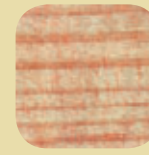

**Douglas Fir.** Clear vertical grain, where a rich, off-white wood is required with similar characteristics to Pine. It can be used as roof decking in shelters, or substituted for Pine in benches, tables and litter receptacles.



**Redwood.** Redwood is naturally resistant to decay, and it weathers nicely. Clear, all-heart Redwood is beautiful and stylish, keeping a consistent color

throughout. Construction heart Redwood is used where thicker Redwood is desired. It has the same characteristics as clear all-heart, but allows for small, tight knots and variations in color.



**Mahogany.** A beautiful dark reddish-brown hardwood which has a natural luster. A durable wood with rich tones, it is a natural for outdoor use in benches, tables and litter receptacles.



**Ipe.** May also be known as Pau Lope. This wood is 3 times harder than Oak, making it an excellent choice for outdoor uses, and where vandal resistance is needed. It

is olive brown in color, but allow for some variations in tone. It weathers to a beautiful gray.



**Purpleheart.** This hardwood is similar in characteristics to Ipe. It is a vivid purple, and weathers to a natural silver-gray. This wood is difficult to carve, and extremely fire resistant.

# LITCH-KICKER STEEL FRAME FINISH COLORS AND SPECIFICATIONS

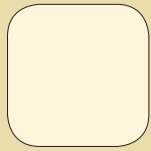

Adobe Tan



Forest Green



Black



Brown

Select a frame finish from the choices above or provide us with an RAL number to create a custom color (at an additional charge).

Test Type	Performance and Properties
Color	Product duplication to a Delta E of 1.0 max.
Gloss Retention	Maintains 75% of its initial gloss level after 500 hrs in QUV
Hardness	After full curing, pencil hardness exceeds an "H"
Adhesion	Rating Level: Excellent
Impact, Direct	100+ in. lb chipping resistance: Rating Level: Excellent
Water Resistance	Passed 7 days immersion without any degradation to film
Humidity Resistance	Passed 7 days humidity cabinet
Gasoline Resistance	30 minutes immersion, no wrinkling, blistering or color change
Hydraulic Resistance	30 minutes immersion, no wrinkling or blistering
Abrasion Resistance	200+ lb. falling sand. No wear through.
Salt Spray	Direct exposure: B1000 - 500+ hrs
Solvent Resistance	50+ mek rubs.
VOC	3.5 MAX

## Protect your Investment from the Elements with the Most Durable Frame Finish in the Industry!

All steel frame and steel furnishing components are finished with our Litchfield exclusive "Litch-Kicker" Baked-on steel frame finish. Before the welded raw steel is sent through our paint line it is sandblasted to a near white condition to eliminate mill scale, dirt & oils, and weld spatter. The sandblasted steel is then coated with the Litch-Kicker catalyzed epoxy/polyurethane premium paint finish, and oven cured at over 400 degrees to create a durable, uniformly applied, beautiful coating in your choice of Adobe Tan, Forest Green, Black or Brown. Many of the colors in the metal roof color charts on page 77 are available at an up-charge.



The strength of the Litch-Kicker finish system is due to the fact that it combines the properties of two well-known high performance systems which are Epoxy and Polyurethane. The excellent adhesion properties of Epoxy combined with the tremendous durability of Polyurethane make Litch-Kicker the best performing wet-coat system for exterior structural steel. All while eliminating the health and environmental issues of typical polyurethanes by formulation without the use of isocyanates.

Testing results show Litch-Kicker to be equal to or better than standard powder coating in corrosion resistance. And Litch-Kicker has the advantage over powder coating by being easier to fix in the field when the finish is damaged during shipping or construction.

# METAL ROOF COLORS

## Pittsburgh Metal Roof Colors

For use on Pittsburgh All-Steel Shelters  
24 gauge Multi-Rib Profile Standard

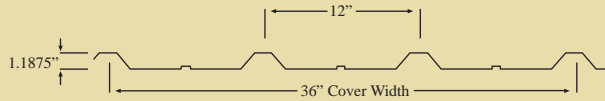

Regal White \*



Surrey Beige \*



Light Stone



Ash Gray \*



Charcoal \*



Matte Black



Roman Blue \*



Patina Green \*



Evergreen \*



Patrician Bronze



Autumn Red



Tudor Brown



Galvalume Plus \*

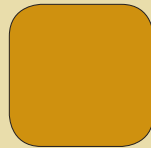

Classic Copper



Regal Blue \*



Brandywine \*



Litchfield Teal



Brite Red \*



Hartford Green

## Litch-Top Metal Roof Colors

Only for use as an overlay on shelters with Tongue & Groove Decking Substrate  
29 gauge Max-Rib Profile Standard

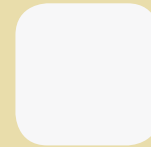
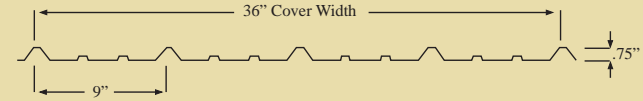

Regal White \*



Roman Blue \*



Clay



Ivory



Surrey Beige \*



Patrician Bronze \*



Ash Gray \*



Light Stone \*



Autumn Red \*



Matte Black



Tudor Brown \*



Charcoal \*



Terratone



Evergreen \*



Galvalume Plus \*



Brandywine



Hartford Green

- Actual metal roof colors may vary slightly.
- Before you place an order, please request an actual color sample from Litchfield Landscape Elements.
- All products feature a 25 year warranty except Brite Red.
- Standing Seam upgrade available at an additional cost.

\* Available in Standing Seam

Note: Inventory and color offerings can change without notice

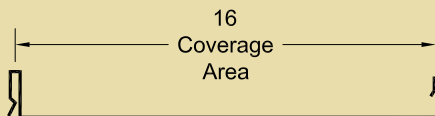

24 gauge Medallion-Lok Profile

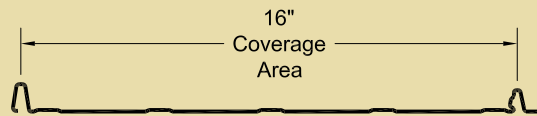

26 gauge Meridian Profile

(800) 542-5282

# WARRANTY AND TERMS

## Litchfield Landscape Elements, Inc. Limited Shelter Warranty

1. Litchfield Landscape Elements, Inc. warrants to the original purchaser of its structures that it will furnish materials free from manufacturing defects for a period of ten (10) years from the date of invoice with the following terms and conditions.

2. This warranty is in effect only if the structure has been assembled and installed strictly in accordance with Litchfield Landscape Elements, Inc.'s setup instructions and good construction practices, and has been subjected only to normal use and exposure.

3. Abnormal conditions are specifically excluded from coverage under this warranty.

4. Contingent liability is specifically excluded. Litchfield Landscape Elements, Inc. has the option to repair or replace any defect in materials.

5. The owner shall notify Litchfield Landscape Elements, Inc. to arrange for an inspection within thirty (30) days after discovery of any defect under this warranty, and before any alteration

or repair is made or attempted.

6. Litchfield Landscape Elements, Inc. is in no way responsible for damages caused by others, including: vandalism, fire, lightning or acts of God, corrosion caused by moisture, chemicals, air or salt spray, pollution, or infestation by rodents or other vermin.

7. This limited warranty shall be null and void if the owner makes any alterations in design.

8. Litchfield Landscape Elements, Inc. shall not be responsible for insurance standards or code compliance changes that may be required in the future

9. Litchfield Landscape Elements, Inc. shall not be responsible for delays due to missing, stolen, or non-conforming parts. Any rework of non-conforming parts must be authorized by Litchfield Landscape Elements, Inc. prior to the time that the rework is done.

10. Some fitting and field cutting of parts will be required, and will not be subject to back

charges or cause for rejection.

11. In the unlikely event of failure, Litchfield Landscape Elements, Inc. reserves the right to alter the design, color, or contributing factors to rectify the condition and help prevent any future recurrence(s).

12. Litchfield Landscape Elements, Inc. specifically excludes any implied warranty of merchantability, of fitness, or of purpose, and there are no warranties, which extend beyond the description of the face hereof.

13. Under no circumstances will Litchfield Landscape Elements, Inc. be responsible for any consequential or incidental damages due to breach of warranty, and such damages are specifically excluded from this warranty.

14. The pre-finished metal roof manufacturer warrants to the purchaser that when used for exterior applications under normal environmental conditions the painted or unpainted metal roof panels will meet the following standards:

Multi-Rib & Max-Rib Metal Roof Panels:

a.) For a period of thirty (30) years from the date of shipment (ten [10] years for Brite Red), the coating system will not crack, check, peel (lose adhesion), chalk or change color (fade).

Standing Seam Metal Roof Panels:

a.) For a period of twenty (20) years from the date of shipment (ten [10] years for Brite Red), the coating system will not crack, check, peel (lose adhesion), chalk or change color (fade).

For a period of thirty (30) years from the date of shipment, painted or unpainted metal roof panels, if erected within the United States, will not rupture, fail structurally, or perforate due to exposure to normal environmental conditions.

Subject to the conditions, limitations and exclusions set forth by the pre-finished metal roof manufacturer.

15. Litch-Kicker is the structure's steel frame finish (unless specifically noted). First, all steel is

sandblasted to remove dirt and oils. Then, the Litch-Kicker Paint Finish, which is a two component system comprised of a rust inhibitive Epoxy finish coated with Polyurethane, is applied. The manufacturer warrants Litch-Kicker to the original purchaser for a period of ten (10) years under normal environmental conditions. The structure may require field painting in the future to help prevent corrosion. Frequency of field painting will depend on (1) the severity of your weather conditions, (2) your storage procedures used before installation, and (3) the care taken by the installer so as not to scrape or scratch finish during installation. Litchfield Landscape Elements, Inc. assumes no responsibility for the finish paint and maintenance of finish paint applied by the contractor in the field.

16. Any Questions? Please contact us by mail, phone, e-mail or on our website at the contact information given on the back cover of this catalog.

## Litchfield Landscape Elements, Inc. Terms and Conditions

**Specifications:** Specification information is available upon request for all of our shelters and site furnishings. Standard design loads on shelters are between 20 lbs. and 45 lbs. per square foot live load, with 90 to 140 miles per hour wind load. If engineer's sealed drawings and calculations are required on shelter plans, please call the factory for cost estimates since fees vary widely by type of shelter and area of country. Shop drawings are available at the discretion of Litchfield Landscape Elements management. Product specifications in this catalog were correct at the time of publication; however, Litchfield Landscape Elements, Inc. reserves the right to change specifications at any time to reflect product improvement.

**Custom Designs:** We welcome the opportunity to develop specific products and specifications to meet your custom design requirements. Do not hesitate to call since some inquiries only involve minor modifications. Occasionally, new designs require extensive investigation and will require a pre-paid design and engineering fee. However, upon receipt and shipment of the order, the fee will be offset in the prices of the approved new product.

**Prices:** Prices are effective as of the date of this catalog, and are F.O.B. Litchfield, Michigan. Freight weights shown are approximate and may vary. Freight is calculated separately, and not included in the pricing. All quotations are firm for 60 days, after which, Litchfield Landscape Elements, Inc. reserves the right to adjust pricing and freight costs to reflect market fluctuations. Applicable taxes are added to invoices unless a tax exempt certificate is provided with order. Prices are subject to change without notice.

**Terms:** Payment in full is required in 30 days after delivery. These net 30-day terms are extended to establish customers who can provide documentation of credit worthiness. If documentation of credit worthiness cannot be provided, payment in full must accompany the order. A service charge of 15% per month will be assessed on the balance of all accounts over 30 days old. No retainages are accepted.

**Delivery:** Depending on the size of the shelter to be delivered, either a common carrier or private carrier will be used. Whenever possible, shelters will be delivered to the job site. Detailed address and directions must

accompany the order. Litchfield Landscape Elements, Inc. and their carriers shall have full authority to stop shipment at the point nearest the job site where road conditions or other hazards do not allow the carrier to safely reach the job site. Transporting of the material from this point on will be the responsibility of the buyer. The carrier's decision in this situation will be final. All freight charges are added to the invoice unless collect shipment arrangements are made when ordering. Time of delivery can vary. Litchfield will make every possible effort to deliver within the pre-determined time period (usually 4-8 weeks or sooner after receipt of design approval). Due to the nature of our product, unforeseen delays production and/or delivery are possible. Litchfield will not honor or be held accountable for liquidated damage charges of any kind whatsoever.

**Receipt of product:** Unloading of the product is the buyer's responsibility. In most cases, a forklift truck is required by and is the responsibility of the buyer for unloading. Buyer or authorized agent must inspect shipment at time of arrival and verify it with the bill of lading. The bill of lading mailed to you at the time of shipment is our receipt from the carrier. We therefore are released of all responsibility

of loss or damage in transit. Damages or shortages shall be noted on the delivery receipt and shall be reported to Litchfield Landscape Elements, Inc. immediately by phone or in writing. Failure to report shortages or damages within two business days of receiving product shall be deemed full and complete acceptance of materials as delivered and will result in a minimum of 1/2 up to and including 100% of replacement cost including shipping.

**Material Storage:** It is the sole responsibility of the buyer to provide for protection of the material after arrival at destination. Storage of wood components and other materials must be in a dry place out of the sun and other elements. Exposure to the sun, rain and other elements can cause warping, staining and other damage. Temporarily stored materials should be placed on blocks well off the ground and separated to allow air circulation around each member. Moisture resistance covers should be used on top and bottom material stacks.

Installation and Assembly: Detailed setup and assembly instructions are included in each shipment along with the hardware. To facilitate the owner's planning of desired site

and concrete work, and shelter layouts and installation, setup instructions are sent certified mail after receipt of order. Some fitting and cutting of parts may be required because of field conditions and will not be reason for rejection or back charges. Touch-up and finish painting and staining shall be the responsibility of the installer. Litchfield Landscape Elements, Inc. assumes no responsibility for the condition of factory-applied finishes damaged or altered by installation or storage procedures. No corrections or alterations are to be made to our products without permission. Back charges must be pre-approved before any product corrections are performed.

**Cancellations and Returns:** May be made only with the consent of Litchfield Landscape Elements, Inc. and any and all costs incurred from date of order are subject to charge. A 15% handling charge, in addition to return freight charges, is made on return of products ordered in error. Custom products and Pre-cut Metal Roofs are non-returnable.



Model 8264DSM Custom 40'X64' Steel Beam Hipped Duo-Top "T" Shelter with 20'X40' Gable Extension, 4:12 roof pitch, 10" square steel columns and 29 gauge Litch-Top pre-cut metal roofing with 2"X6" Southern Yellow Pine T&G roof decking (masonry by others)

***Your Design Possibilities are Limitless with Litch.eld!***



Model 8182P Custom Pittsburgh Performance Shelter utilizes a 50' Square Duo-Top adjoined to a 22'X36' Hip End Duo-Top which shares common supports with the 50' Square Duo-Top. Custom features include custom ornate laser-cut top tier lattice, custom column to beam connection and custom header lattice. Column masonry by others.

With over 35 years in the industry and a vast wealth of experience gained from all those years assures you that each Litchfield product that leaves through our doors is built with the utmost degree of skill and craftsmanship. The design and engineering techniques we employ allow us to manufacture shelters of massive proportions and our custom design capabilities give you the latitude to design your project with highly detailed specifications which fit your site requirements. You can feel completely confident that when you specify a Litchfield product you are receiving a shelter or site furnishing that is the absolute best the industry has to offer!



Litchfield Landscape Elements is represented locally by:



Litchfield Landscape Elements 4 Industrial Drive Litchfield, MI 49252  
(800) 542-5282 (517) 542-2988 Fax (517) 542-3939  
[www.LandscapeElements.com](http://www.LandscapeElements.com)