

PLAYLAND

Building Tomorrow's Play Environments Today

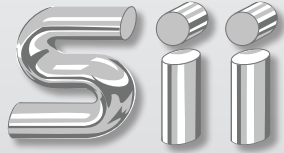

Playland Guidebook
Volume 26



Superior International Industries

Playland is proud to be part of the Superior International Industries (SII) family of playground, park and recreational products companies.



Providing shade products for virtually every type of playground and other outdoor situation - no matter the size, shape or location.
 www.superiorshadeinc.com
 sales@superiorshadeinc.com
 Toll Free: 1.888.829.8997
 Local: 770.838.1417
 Fax: 770.834.2764



Play On Surfacing



PlayOn Surfacing supplies impact absorbing surfacing to playground and sports market and is the major distributor of Astroturf products for the recreation industry.
 www.playonsurfacing.com
 info@playonsurfacing.com
 1.888.714.8409



Playsystems designs and builds custom play environments for restaurants, water parks and entertainment facilities.
 playsystems.superiorinternational.com
 juan.cuellar@superiorinternational.com
 800.327.8774



CHILD WORKS®

Child Works is the leading supplier of component parts, swings and accessories to the worldwide playground industry. Child Works is your source for commercial and residential playground components.
 www.childworks.com
 sales@childworks.com
 800.327.8774



Small Water Slides delivers affordable standard, themed, or interactive slides bringing water park fun to your local pool. "The most splash for your cash".
 www.smallwaterslides.com
 info@smallwaterslides.com
 800.247.8578



Custom manufacturer of high quality Picnic Shelters, Gazebos, Arbors and Site furnishings of all shapes and sizes for over 35 years. Products available in steel or wood designs with unlimited custom options to choose from.
 www.siistructures.com
 800.356.4727



WEBCOAT has been manufacturing long lasting, corrosive resistant outdoor tables and benches for more than 16 years. Webcoat products use high strength steel fabrication with the newest technologies in Thermo-Plastic coatings
 www.webcoat.com
 webcoat@webcoat.com
 800.505.5101



With quality engineering at an affordable price, Playland is one of the only playground companies in the market today that has leaders that are lifelong "Playground People."
 www.playland-inc.com
 sales@playland-inc.com
 Toll Free: 800.356.4727
 Fax: 770.834.6495

Introduction

- About Playland **Page 04**
- IPEMA **Page 05**
- Playground Planning **Page 07**

New Products

- See Playland's New Items **Page 09**

Ages 5 to 12

- Introduction to Age Group **Page 12**
- Active: Fitness Focused Play **Page 13**
- Steel Modular Playstructures **Page 18**
- Recycled Playstructures **Page 32**

Ages 2 to 5

- Introduction to Age Group **Page 35**
- KidsCenters™ **Page 36**
- Toddler Maze **Page 38**
- Steel Modular Playstructures **Page 40**
- Recycled Playstructures **Page 46**

Ages 2 to 12

- Introduction to Age Group **Page 49**
- Steel Modular Playstructures **Page 50**
- Recycled Playstructures **Page 62**

Modular Components

- Introduction to Components **Page 64**
- Decks **Page 65**
- Accessories **Page 66**
- Stairs/Ramps **Page 67**
- Bridges **Page 68**
- Horizontal Ladders **Page 70**
- Climbers **Page 72**
- Slides **Page 76**
- Tube Slides **Page 78**
- Crawl Tunnels **Page 79**
- Activity Panels/Barriers **Page 80**
- Roofs **Page 84**

Swings

- Swing Frames **Page 86**
- Swing Seats & Parts **Page 89**

Independent Events

- Introduction to Events **Page 92**
- Climbers **Page 93**
- Slides **Page 97**
- Freestanding Events **Page 98**
- Riders **Page 100**
- Activities **Page 101**
- Fitness, Sports & Games **Page 104**

Water Park

- See Playland's Waterslides **Page 106**

Site Amenities

- Introduction to Amenities **Page 108**
- Tables & Benches **Page 109**
- Accessories **Page 123**
- Receptacles **Page 124**

Shade

- Shade Structures **Page 126**

Shelters

- Architectural Elegance **Page 130**

Warranty/ISO

- Playland Warranty **Page 132**
- ISO Certificate **Page 133**

Warranty/ISO

- Play With Color **Page 134**

From Humble Beginnings to Industry Leaders

We were founded...

In 1983 Donald Strickland and Anthony Strickland started making seesaws and swing sets out of a converted mechanic's garage. The original Playland was truly a family affair with the father and son team both fabricating and selling the company's products.

Along the way...

In 1990 Anthony Strickland took over the company as President and CEO and set out on a course to develop the beginnings of what is the current product line of modular play systems, originally and fondly named Playland Systems.



The "Playground People" Merger

Playland became a division of Superior International Industries in 1997. SII, as their customers know them, was founded in 1991 by Rob Pepper and Ray Derbecker as a components supplier to both the commercial and residential playground industry. While building on their customer base, they partnered with one of the original founders of Playland, Anthony Strickland, in 1997 to form the new Playland. This new partnership

was unique because, as a group of investors and partners, they have spent their lives in the playground industry. They proudly say that Playland is one of the only playground companies in the market today that has leaders that are lifelong "Playground People."

Today's Playland

Then and now, Playland's mission is to build high quality commercial outdoor play products at an affordable price while maintaining the highest safety standards in the industry.

With over 300,000 square feet of combined manufacturing space and utilizing in-house technologies of rotational molding, metal fabrication and custom fabric forming, we produce 95% of the products we sell. In a multi-phase manufacturing process, Playland uses Dura-Guard™ Galvanized Weld Protection, a pre-sanding and hand cleaning power prep process, and finally a baked-on powder-coat finishing process.



Engineered for Fun!

Quality engineering returns quality results. The Playland design team utilizes SOLIDWORKS™ engineering software for new product engineering and implementation. We live every day for one simple reason... to design, build and deliver the highest quality products with ultimate PLAY-ON POWER!

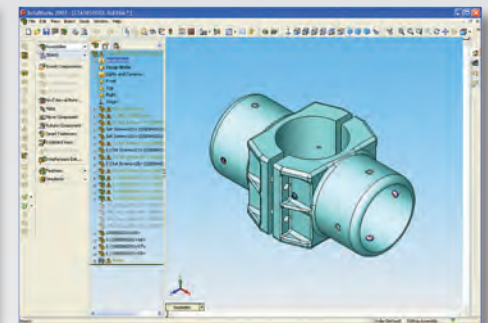

ISO Certified

To ensure that you get the best quality product, Playland is proud to announce that we are now ISO certified to ISO 9001:2000 standards. See our certificate on page 133.



IPEMA Certified

In the interest of playground safety, IPEMA provides a 3rd Party Certification Service whereby a designated independent laboratory validates a participant's certification of conformance to ASTM F1487, Standard Consumer Safety Performance Specification for Playground Equipment for Public Use. The use of the corresponding logo in the Playland Guidebook signifies that Playland has received written validation from the independent laboratory that the products associated with the use of the logo conforms with the requirements of the indicated standard. Check the IPEMA web site (www.ipema.org) to confirm product certification.



Playgrounds Packed with Play-on Power!

Take note of an important Playland innovation: the Expedition and Adventure series are two versions of the same design. Expedition playgrounds have 5" diameter steel posts, 48" deck grids and 30" plastic tubes to accommodate larger groups of children. The Adventure series offers the same durability and quality as the Expedition, but on a 3.5" diameter steel post basis with 36" deck grids and 24" plastic tubes -- perfect for limited space and budgets. Both series are fully modular and designed for a wide age group of children (2-12).



Also available is our recycled line. This combines many of our Expedition Series play components with square posts made from recycled plastic milk jug material. Many of our standard Expedition units may be reconfigured to use these recycled posts. The recycled line is available only in a 48" grid with 5" square posts. You can use the following pages to choose a design off-the-shelf or as inspiration for your custom design. Either way, with Playland you get great play value and **Play-on Power!**

“Playgrounds must provide activities that are appropriate for the physical, social, emotional and learning level of the children using the playground.”

-Ken Kutska,
Points About Playgrounds

Age Specific Play

Our catalog is divided into color coded age groups. Each age section includes some of our most popular play structures as well as brand new designs. There are many great choices to fit your needs and budget.



By the Numbers

In addition to age groupings, we also provide vital information for each structure. Play structure Series (Expedition/Adventure, etc.), playstructure unit number, child capacity, actual dimensions, ASTM required use zones. Shipping weight, ADA requirements and a list of all play events are also provided.

Example

| | | EXPEDITION SERIES | ADVENTURE SERIES |
|---|----------------|---------------------------|---------------------------|
| Playstructure ID Number | Unit Number | PS5-00000 | PS3-00000 |
| Budget Information | Unit Price | \$00,000 | \$00,000 |
| Playstructure Capacity | Child Capacity | 00 | 00 |
| Structure Dimensions | Actual Size | 00'x00' (0x0m) | 00'x00' (0x0m) |
| Use Zone Dimensions | ASTM Use Zone | 00'x00' (0x0m) | 00'x00' (0x0m) |
| Shipping Weight | Weight | 0,000lbs (0,000kg) | 0,000lbs (0,000kg) |
| Important Information for ADA Accessibility | ADA Requires | 0 ground level components | 0 ground level components |

Overhead Renderings

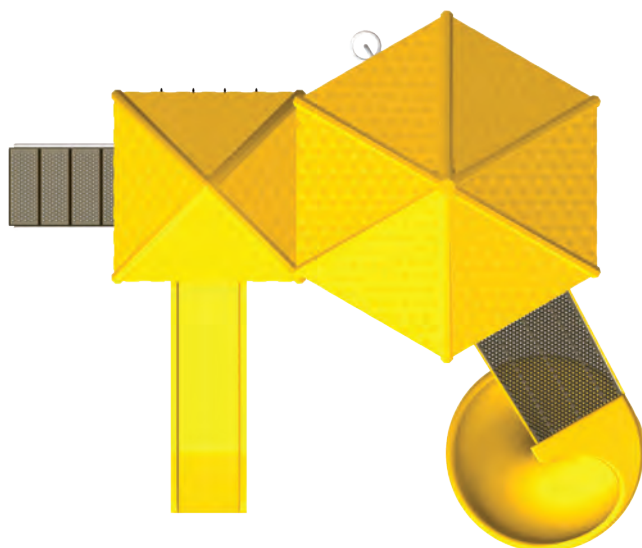

“Front & Back” views



Create a fun station one phase at a time

Phasing is an excellent way to limit your initial funding needs. You can match a part of your playground plans to your first year's budget. You can begin with your ADA access point and expand into slides and climbers.

Annual additions, in line with annual budgets, can be made to complete your original playground vision. Note how the unit pictured here was accomplished in three years.

By phasing your playground; landscaping, independent events and site amenities can be included in your budget from the beginning.

So, remember to create a complete plan. We'll show you how to make your fun station one phase at a time!

Mission Control

- Exciting Playground Goals
- Careful Phasing-in of Components
- Annual Budget Line



Example:



| Unit Number | PS3-20460 |
|----------------|---------------------------|
| Phase 1 | \$11,301 |
| Phase 2 | \$5,044 |
| Phase 3 | \$5,210 |
| Total Price | \$21,555 |
| Child Capacity | 44 |
| Actual Size | 38'x22' (12x7m) |
| ASTM Use Zone | 53'x36' (16x11m) |
| ADA Requires | 0 ground level components |



7 Play Events Featuring:

- Rock Wall Climber
- Education Climber
- Tri Rung Horizontal Ladder
- Wave Slide
- Sliding Pole
- ADA Transfer Station
- Coil Climber



12 Play Events Featuring:

- Alpine Thunder Slide
- Alpha Panel
- Talk Tubes
- Store Front Panel
- Pipe Wall
- Post Mount Steering Wheel



15 Play Events Featuring:

- Bedrock Climber
- Triple Rail Slide
- Lily Pad Bridge
- Log Roll
- Tic-Tac-Toe Panel

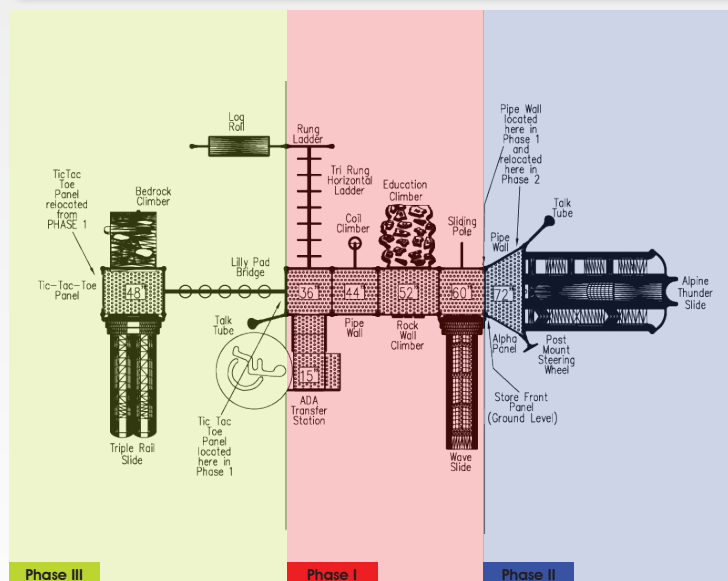

Brand New Items from Playland!

Check out Playland's wide range of new park and play products packed with tons of **Play On Power!**

superior SHAPE™

Experience a new level of fitness and comfort with our new line of dedicated outdoor fitness equipment. Designed with ergonomics in mind, superior SHAPE products are the perfect addition to any outdoor fitness area, and are made to stand up to the elements.

Page 10



ACTIVE Fitness Focused Play

Put the fun back in fitness with our new linear line of equipment with fitness focused events. Active components can even be used as play events on Expedition series play units.

Page 13



Jungle Theme

Tropical inhabitants await your imagination in these new activity panels.

Page 82



Toddler Maze

Playland's latest line of play structures encourages imaginative play while maximizing component usability for toddlers.

Page 38

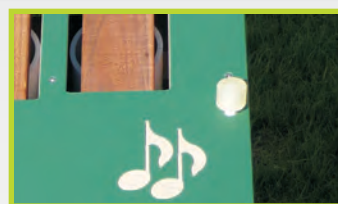

Musical Play

Our new freestanding musical activities encourage individual and group play.

Page 11



Deluxe Gas Station

For extra play value, this upgraded Playland classic includes two Store Front panels and Talk Tubes.

Page 101



Road Signs

Add these familiar traffic details to your trike and walking paths.

Page 83



Architectural Timber Borders

Molded from real stone masonry.

Page 123

s u p e r i o r
SHAPE

Experience a new level of fitness and comfort with our new line of dedicated outdoor fitness equipment. Designed with ergonomics in mind, Superior SHAPE products are the perfect addition to any outdoor fitness area, and are made to stand up to the elements.

Fabricated to the same quality specifications as our playground products, Superior SHAPE equipment is built to last. Combining time-tested utility and modern aesthetics make these new items a must for beginners and enthusiasts alike. Available in your choice of colors, including silver (as pictured) - See page 135 for color selections.



Sit-Up Bench



Pull-Up Station



Glider



Stretcher

| Description | Item # | Weight | Price |
|--------------------------|-----------|------------------|---------|
| Sit-Up Bench | AFT13972 | 100 lbs. (45 kg) | \$985 |
| Glider | AFT14005 | 190 lbs. (86 kg) | \$1,305 |
| Pull-Up Station | AFT14031 | 155 lbs. (70 kg) | \$1,237 |
| Stretcher | AFT14038 | 115 lbs. (52 kg) | \$523 |
| In-Ground Mount Letg Kit | FIT-14050 | 21 lbs (9.5 kg) | \$325 |

Musical Play Rocks!

Children of all ages enjoy exploring sound and music. Playland's newest activity set encourages children to both hear and make music, promoting listening, language, math and science skills, as well as both individual and group play. Choose from 5 different instruments that allow children to explore rhythm, tone and harmony.

| Description | Item # | Price |
|---------------|--------|---------|
| Wood Marimba | 77135 | \$1,360 |
| Steel Marimba | 77137 | \$1,360 |
| Glockenspiel | 77128 | \$474 |
| Piano | 77133 | \$940 |
| Bongos | 77134 | \$597 |



Glockenspiel

\$474



Wood Marimba

\$1,360

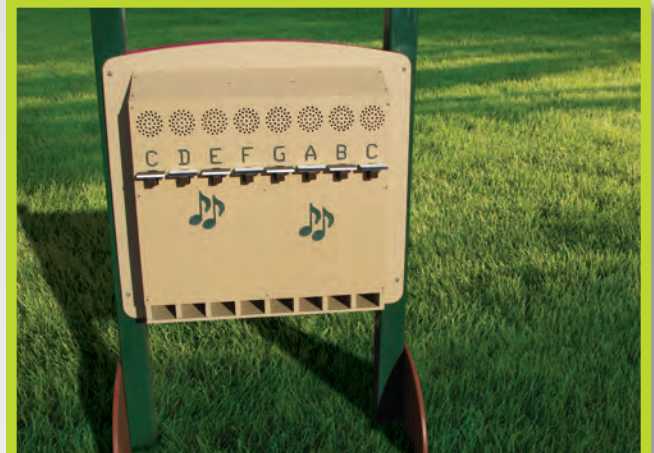

Piano

\$940 (\$1,094 with posts)



Steel Marimba

\$1,360



Bongos

\$597

For Ages
5 to 12

Hand, eye and playground coordination

Here, our focus is more on physical challenge. Major muscle development is the source and inspiration for component and playground design. We've zeroed in on this group with challenging horizontal ladders, climbers and slides. By emphasizing popular components and combining them dynamically, our playgrounds create energy, focus attention and create a great new place for social interactions.

The 5 to 12 age group requires wider slide bedways than the younger children. Horizontal ladders may launch from decks up to 36" high and may be as high as 84" off the ground.



With childhood obesity becoming a major issue, Playland is proud to introduce our new Active Series of fitness focused play structures, as shown on the opposite page. This line is a ground based concept that features overhead, climbing, traversing and motion events. Active is the future of play.

We also offer our modular Expedition (5") and Adventure (3.5") series structures for ages 5-12. Pick from one of our many catalog units, or allow us to design one to fit your needs.

You may also choose to go green with one of our recycled series structures using posts made from 100% recycled milk jug plastic.

- Active: Fitness Focused Play **Page 13**
- Steel Modular Playstructures **Page 18**
- Recycled Playstructures **Page 32**

For Ages
5 to 12

\$9,652
5" Only



This Playground is Designed for Children 5 to 12 Years Old
For Ages 5 to 12
Adult Supervision is Recommended

ACTIVE

Fitness Focused Play



Unit #PA5-25335

7 Play Events Featuring:

- Syclone Spinner
- Chain Climbing Wall
- Arched Tri-Rung Horizontal Ladder
- Curved Trapeze Ring Horizontal Ladder
- Wiggle Walk
- Rail Slide
- Wheel Swinger

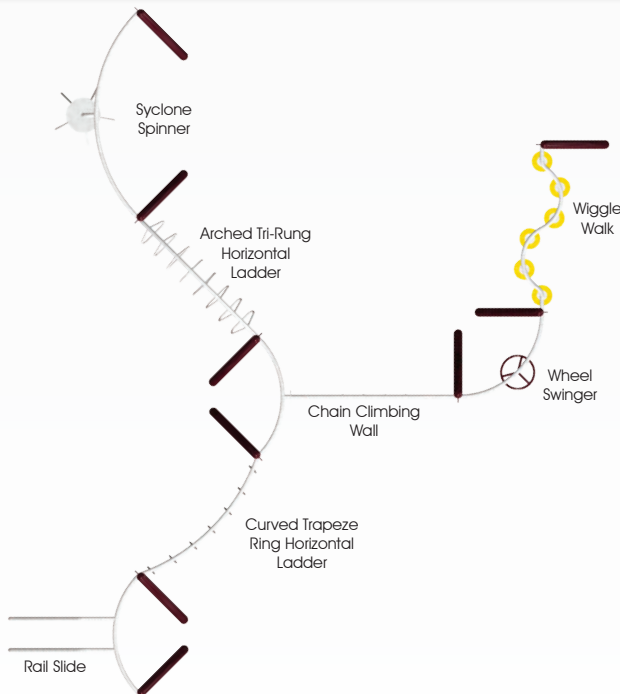

| Unit Number | PA5-25335 |
|----------------|--------------------|
| Unit Price | \$9,652 |
| Child Capacity | 14 |
| Actual Size | 39'X27' (12x8m) |
| ASTM Use Zone | 51'X39" (15.5X12m) |
| Weight | 1,599lbs. (725kg) |
| ADA Requires | N/A |



\$3,143
5" Only

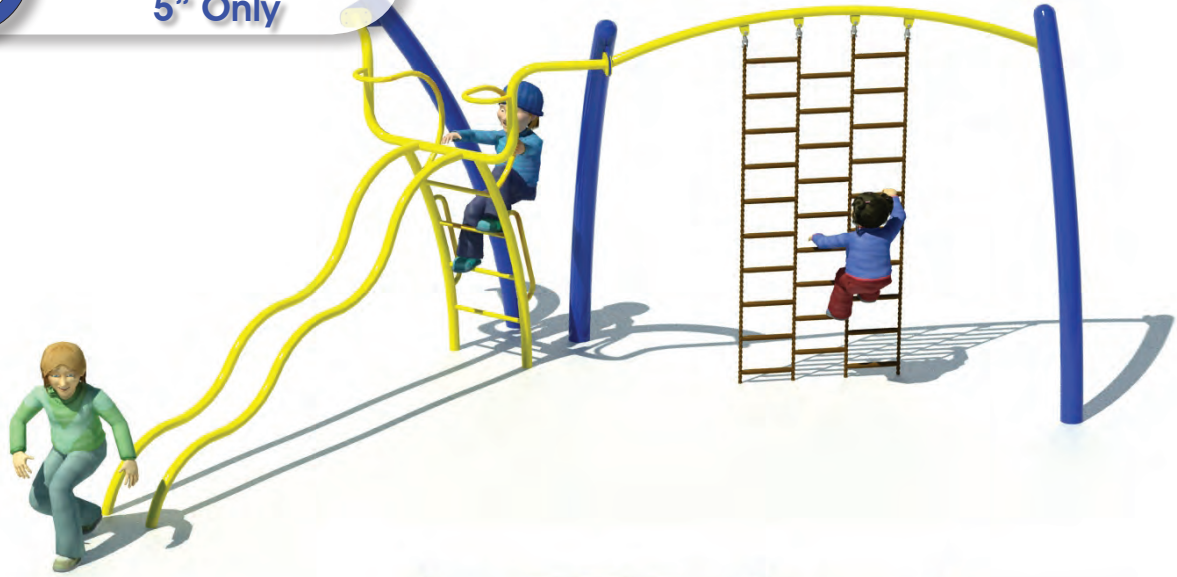

Unit #PA5-26440

2 Play Events Featuring:

- Chain Climbing Wall
- Rail Slide

| | |
|--------------------|---------------------------|
| Unit Number | PA5-26440 |
| Unit Price | \$3,143 |
| Child Capacity | 6 |
| Actual Size | 17'X10' (5x3m) |
| ASTM Use Zone | 29'X22' (9X7m) |
| Weight | 620lbs. (281kg) |
| ADA Requires | 0 ground level components |

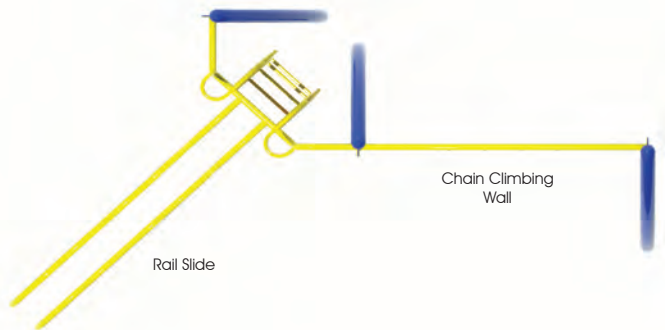

For Ages
5 to 12

\$4,456
5" Only



This Playground is Designed for Children 5 to 12 Years Old
For Ages
5 to 12
Adult Supervision is Recommended



Unit #PA5-26366

3 Play Events Featuring:

- Syclone Spinner
- Chain Climbing Wall
- Curved Tri-Rung Horizontal Ladder

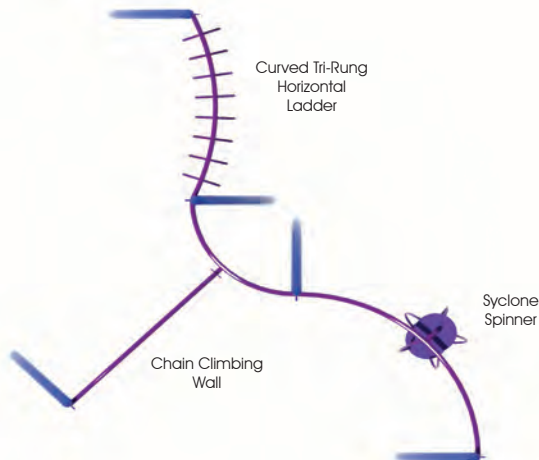

| Unit Number | PA5-26366 |
|----------------|---------------------------|
| Unit Price | \$4,456 |
| Child Capacity | 10 |
| Actual Size | 16'X18' (5x5.5m) |
| ASTM Use Zone | 28'x30' (8.5x9m) |
| Weight | 852lbs. (386kg) |
| ADA Requires | 0 ground level components |

For Ages
5 to 12

\$8,113
5" Only

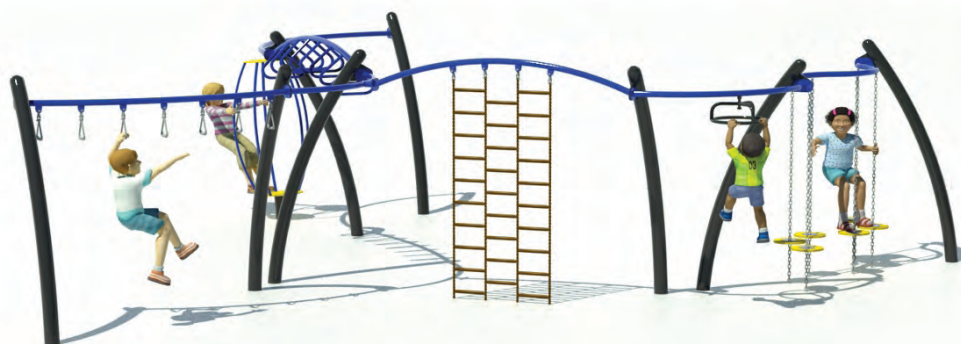
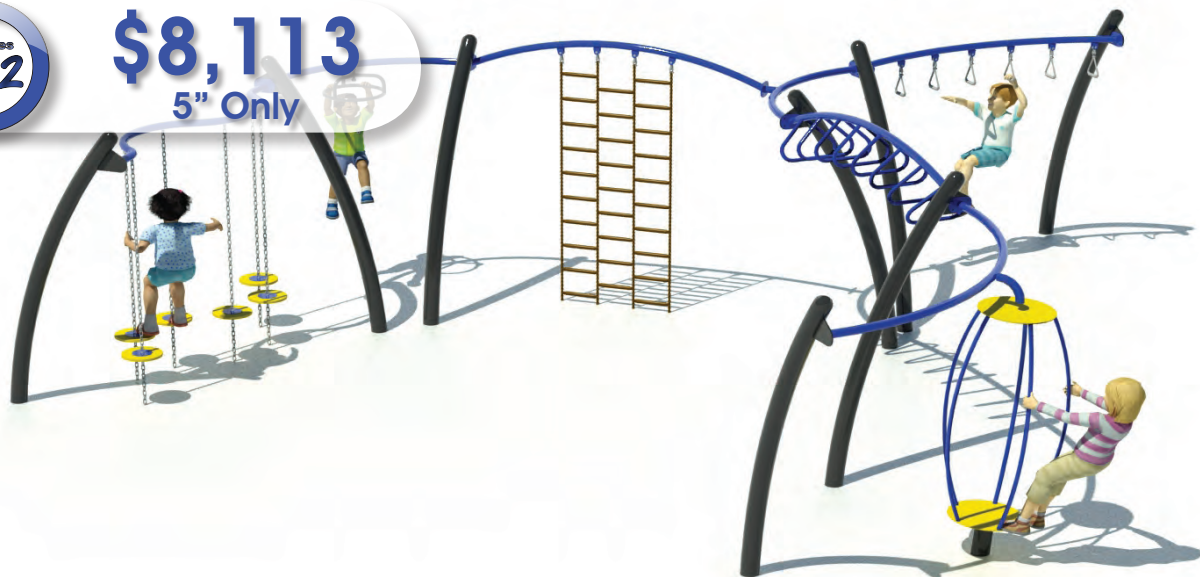

Unit #PA5-26470

6 Play Events Featuring:

- Chain Climbing Wall
- Syclone Spinner
- Wiggle Walk

| Unit Number | PA5-26470 |
|----------------|---------------------------|
| Unit Price | \$8,113 |
| Child Capacity | 15 |
| Actual Size | 25'X32' (7.5X10m) |
| ASTM Use Zone | 37'X44' (11x13.5m) |
| Weight | 1,305lbs. (592kg) |
| ADA Requires | 0 ground level components |

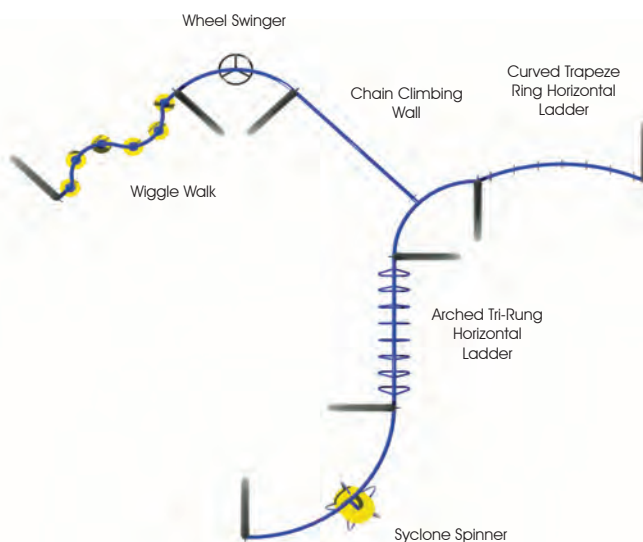

For Ages
5 to 12

\$10,440
5" Only

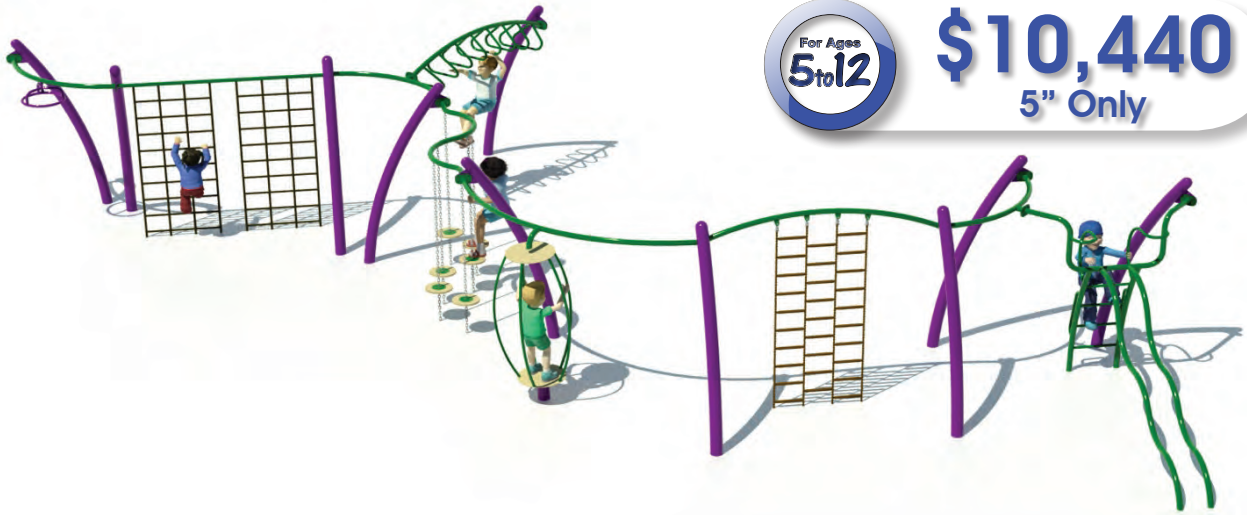

Unit #PA5-26510

7 Play Events Featuring:

- Syclone Spinner
- Chain Climbing Wall
- Curved Tri-Rung Horizontal Ladder
- Wiggly Walk

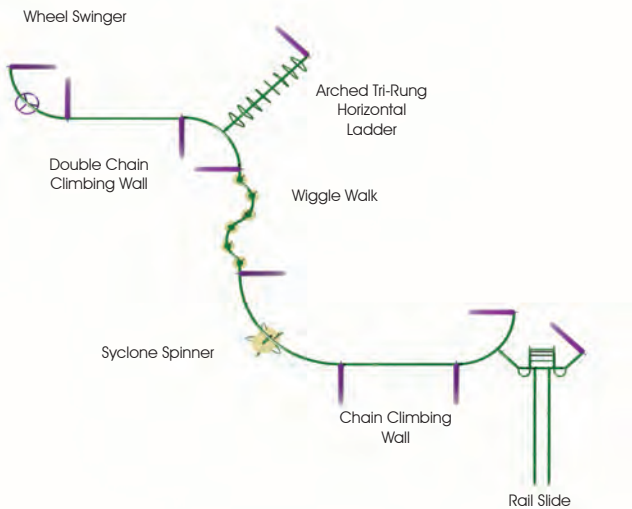

| Unit Number | PA5-26510 |
|----------------|---------------------------|
| Unit Price | \$10,440 |
| Child Capacity | 20 |
| Actual Size | 49'X20' (15x5.6m) |
| ASTM Use Zone | 61'X32' (18.5x10m) |
| Weight | 1794lbs. (814kg) |
| ADA Requires | 0 ground level components |

For Ages
5 to 12

\$81,310
5" Only



Unit #25210



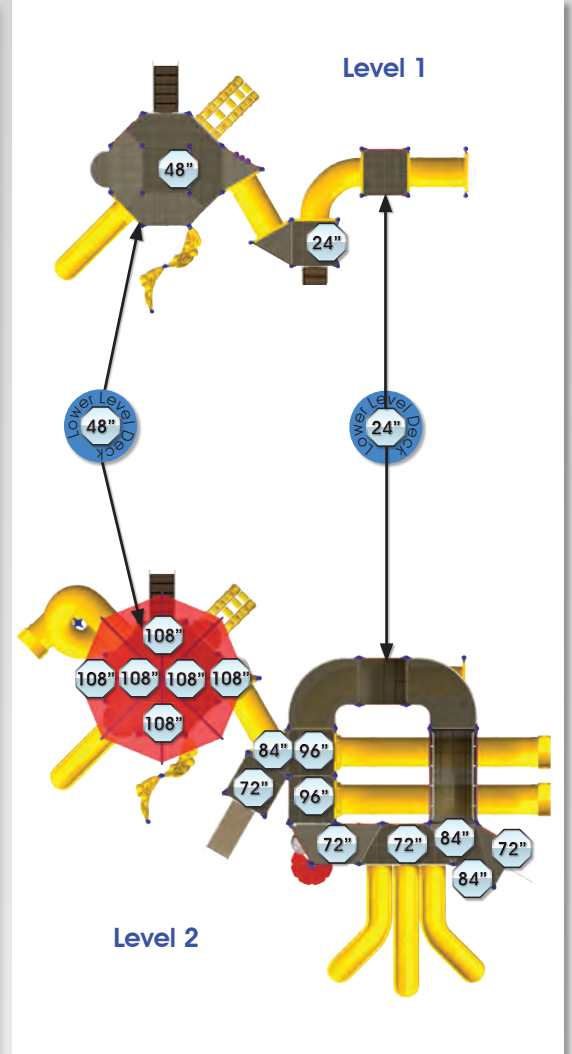

30 Play Events Featuring:

- Straight Tube Slide (x2)
- Incline Crawl Tunnel (x3)
- Alpha Panel
- Bubble Panel (x3)
- Geo Panel
- Spelling Panel
- Tic-Tac-Toe Panel
- Window Panel (x2)
- Gear Panel
- Spiral Climber
- Ball Turn Panel
- Sun Deck Gate w/Wheel (x2)
- Airplane Panel
- Solar System Panel
- Quick Climber
- Straight Chute Slide
- Tri-Chute Slide
- Chain Link Climber
- Honey Bee Panel
- State Panel
- 90° Crawl Tunnel
- 360° Spiral Tube Slide
- Bubble Wall Climber



| Unit Number | PS5-25210 |
|----------------|---------------------------------------|
| Unit Price | \$81,310 |
| Child Capacity | 192 |
| Actual Size | 50'x36' (15x11m) |
| ASTM Use Zone | 62'x48' (19x15m) |
| Weight | 11,313lbs. (5,132kg) |
| ADA Requires | Does Not Meet ADA Guidelines As Shown |



For Ages
5 to 12

\$33,581
as shown (3.5")



Unit #25043

12 Play Events Featuring:

- Lily Pad Climber
- Store Front Panel
- Spiral Slide
- Coil Climber
- Below Deck Bench (x2)
- Alpine Thunder Slide
- Chute Slide
- Bedrock Climber
- Bubble Wall Bridge
- Deep Rung Arch Climber



| Unit Number | PS5-25043 | PS3-25043 |
|----------------|---------------------------|---------------------------|
| Unit Price | \$38,495 | \$33,581 |
| Child Capacity | 66 | 54 |
| Actual Size | 52'x45' (16x14m) | 49'x42' (15x13m) |
| ASTM Use Zone | 64'x57' (20x17m) | 61'x54' (19x16m) |
| Weight | 6,475lbs (2,937kg) | 4,389lbs (1,991kg) |
| ADA Requires | 0 ground level components | 0 ground level components |

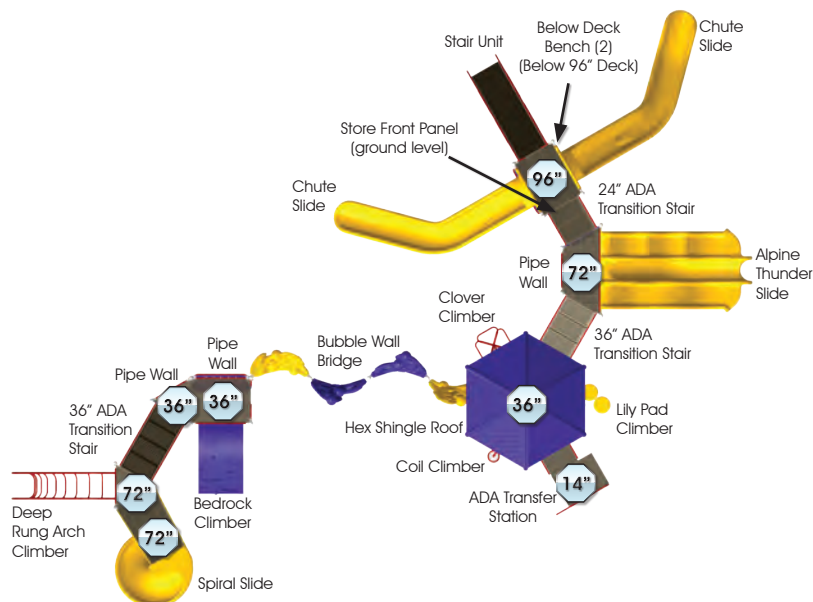

For Ages
5 to 12

\$27,753
as shown (5")



Unit #25021

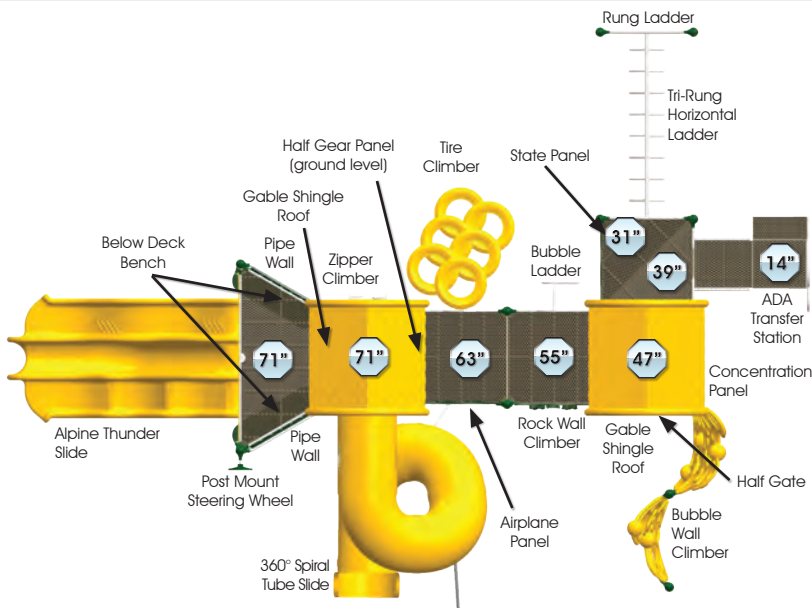

16 Play Events Featuring:

- 360° Spiral Tube Slide
- Concentration Panel
- Pst. Mt. Steering Wheel
- Below Deck Bench (x2)
- Zipper Climber
- Tire Climber
- Tri-Rung Horizontal Ladder
- Rung Ladder
- Half Gear Panel
- Rock Wall Climber
- Airplane Panel
- Bubble Ladder
- Alpine Thunder Slide
- State Panel
- Bubble Wall Climber



| Unit Number | PS5-25021 | PS3-25021 |
|----------------|---------------------------|---------------------------|
| Unit Price | \$27,753 | \$24,007 |
| Child Capacity | 46 | 40 |
| Actual Size | 35'x26' (11x8m) | 35'x23' (11x7m) |
| ASTM Use Zone | 47'x38' (14x12m) | 47'x35' (14x11m) |
| Weight | 4,386lbs (1,990kg) | 3,296lbs (1,495kg) |
| ADA Requires | 0 ground level components | 0 ground level components |

For Ages
5 to 12

\$26,485
as shown (5")



Unit #18279

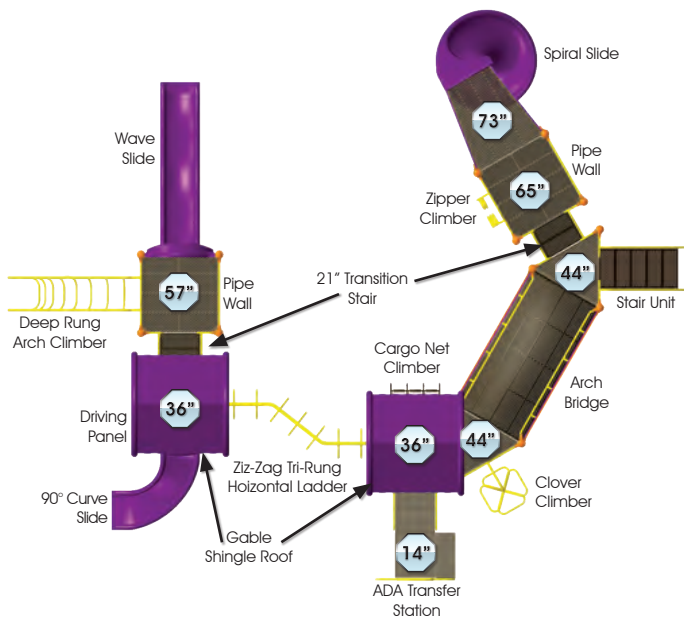

9 Play Events Featuring:

- 90° Curve Slide
- Cargo Net Climber
- Wave Slide
- Driving Panel
- Spiral Slide
- Zipper Climber
- Deep Rung Arch Climber
- Clover Climber
- Zig-Zag Tri-Rung Horizontal Ladder



| Unit Number | PS5-18279 | PS3-18279 |
|----------------|---------------------------|---------------------------|
| Unit Price | \$26,485 | \$21,643 |
| Child Capacity | 56 | 35 |
| Actual Size | 34'x29' (11x9m) | 33'x28' (10x9m) |
| ASTM Use Zone | 46'x41' (14x12m) | 45'x40' (14x12m) |
| Weight | 4,552lbs (2,064kg) | 3,790lbs (1,719kg) |
| ADA Requires | 3 ground level components | 3 ground level components |



For Ages
5 to 12

\$22,668
as shown (5")



3.5" Version

allied
TUBE & CONDUIT
5" Version

Design Note: Slide hoods pictured will be replaced with our new design as seen in rendered view.

Unit #17690



5" Version

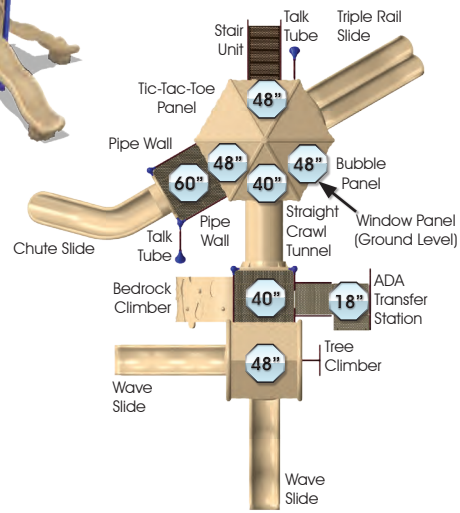

11 Play Events Featuring:

- Wave Slide (x2)
- Chute Slide
- Triple Rail Slide
- Bedrock Climber
- Tree Climber
- Bubble Panel
- Window Panel
- Tic-Tac-Toe Panel
- Talk Tube
- Straight Crawl Tunnel



| Unit Number | PS5-17690 | PS3-17690 |
|----------------|---------------------------|---------------------------|
| Unit Price | \$22,668 | \$20,352 |
| Child Capacity | 42 | 38 |
| Actual Size | 33'x28' (10x9m) | 33'x19' (10x6m) |
| ASTM Use Zone | 45'x40' (14x12m) | 45'x31' (14x9.5m) |
| Weight | 3,529lbs (1,600kg) | 3,119lbs (1,414kg) |
| ADA Requires | 0 ground level components | 0 ground level components |

For Ages
5 to 12

\$23,002
as shown (5")



Design Note: Slide hoods pictured will be replaced with our new design as seen in rendered view.



Unit #17267

This structure is not ADA compliant as shown. Contact us to see how we can modify this design to fit your needs.

5" Version

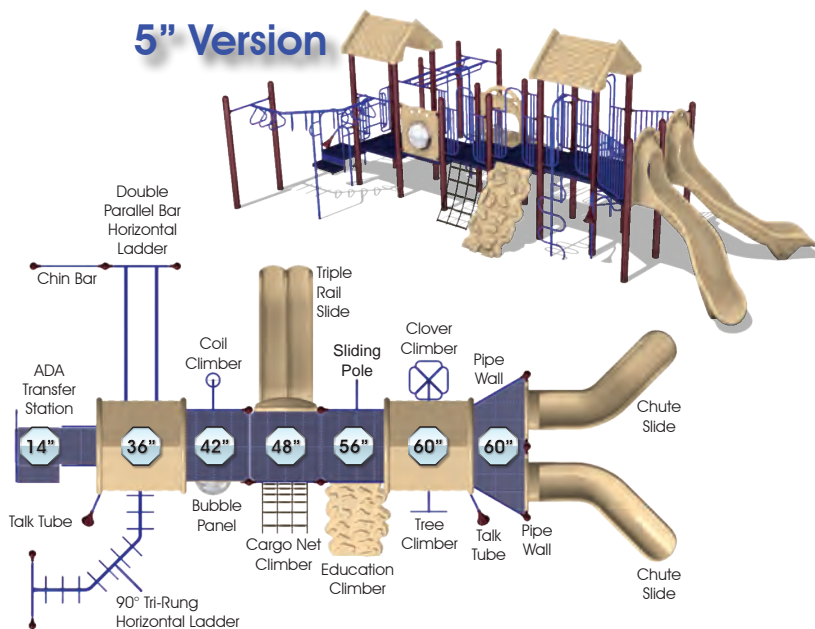

13 Play Events Featuring:

- Chute Slide (x2)
- Triple Rail Slide
- Tree Climber
- Education Climber
- Cargo Net Climber
- Coil Climber
- Clover Climber
- Sliding Pole
- Bubble Panel
- Talk Tube
- Chin Bar
- 90° Tri-Rung Horizontal Ladder
- Double Parallel Bar Horizontal Ladder



| Unit Number | PS5-17267 | PS3-17267 |
|----------------|---------------------------|---------------------------|
| Unit Price | \$23,002 | \$19,749 |
| Child Capacity | 45 | 44 |
| Actual Size | 38'x21' (12x6m) | 33'x21' (10x6m) |
| ASTM Use Zone | 50'x33' (15x10m) | 45'x33' (14x10m) |
| Weight | 3,990lbs (1,809kg) | 3,312lbs (1,502kg) |
| ADA Requires | 0 ground level components | 0 ground level components |

For Ages
5 to 12

\$18,645
5" Only



Unit #25085

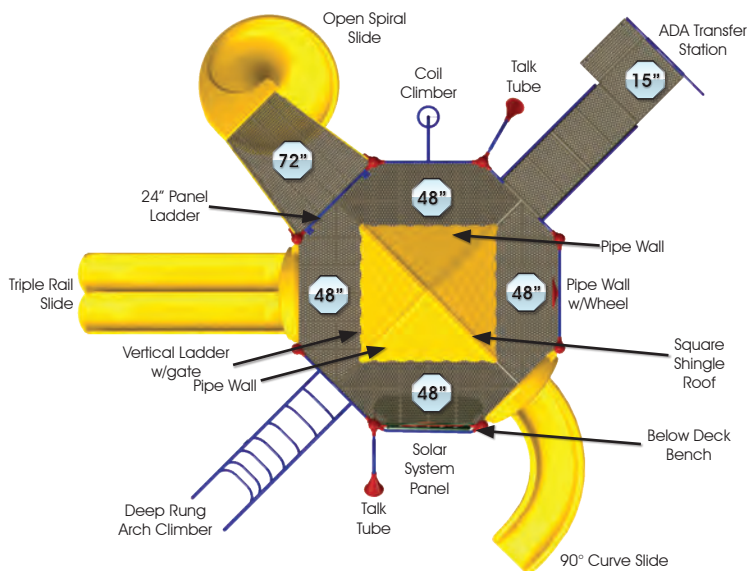

10 Play Events Featuring:

- Vertical Ladder
- Open Spiral Slide
- 90° Curve Slide
- Pipe Wall w/Wheel
- Deep Rung Arch Climber
- Below Deck Bench
- Coil Climber
- Talk Tube
- Solar System Panel
- Triple Rail Slide



| Unit Number | P55-25085 |
|----------------|---------------------------|
| Unit Price | \$18,645 |
| Child Capacity | 33 |
| Actual Size | 23'x21' (7x6m) |
| ASTM Use Zone | 35'x33' (10.5x10m) |
| Weight | 3,128lbs. (1,419kg) |
| ADA Requires | 0 ground level components |

For Ages
5 to 12

\$15,561
as shown (3.5")



This structure is not ADA compliant as shown.
Contact us to see how we can modify this design to fit your needs.

Unit #20368

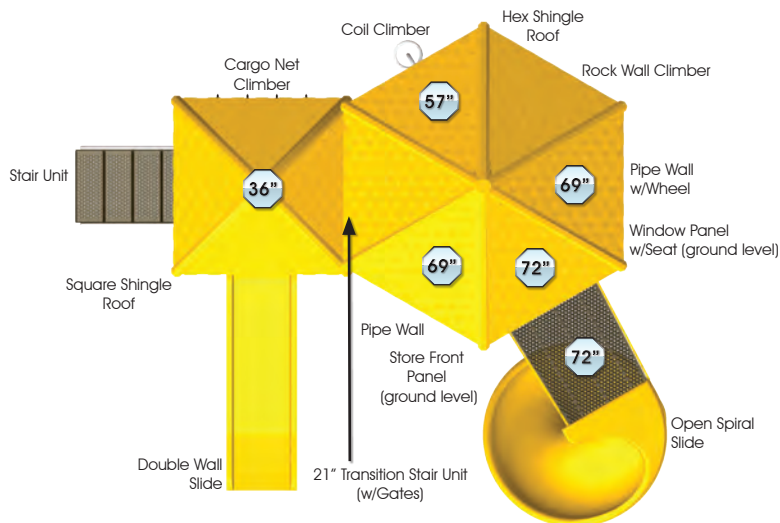

8 Play Events Featuring:

- Rock Wall Climber
- Coil Climber
- Cargo Net Climber
- Double Wall Slide
- Store Front Panel
- Pipe Wall w/Wheel
- Window Panel w/Seat
- Spiral Slide



| Unit Number | PS5-20368 | PS3-20368 |
|----------------|---------------------------------------|--------------------|
| Unit Price | \$18,599 | \$15,561 |
| Child Capacity | 36 | 28 |
| Actual Size | 18'x16' (6x5m) | 17'x14' (5x4m) |
| ASTM Use Zone | 30'x28' (9x8.5m) | 29'x26' (9x8m) |
| Weight | 3,012lbs (1,366kg) | 2,393lbs (1,086kg) |
| ADA Requires | Does Not Meet ADA Guidelines As Shown | |

For Ages
5 to 12

\$14,139
as shown (3.5")



Unit #25013

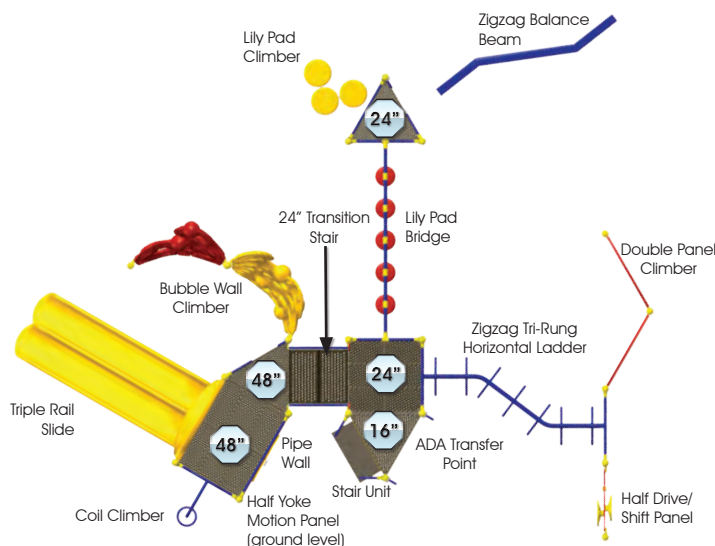

10 Play Events Featuring:

- Lily Pad Climber
- Balance Beam
- Coil Climber
- Lily Pad Bridge
- Bubble Wall Climber
- Triple Rail Slide
- Double Panel Climber
- Half Driving Panel
- Half Yoke Motion Panel
- Zig-Zag Tri-Rung Horizontal Ladder



| Unit Number | PS5-25013 | PS3-25013 |
|----------------|---------------------------|---------------------------|
| Unit Price | \$17,129 | \$14,139 |
| Child Capacity | 34 | 28 |
| Actual Size | 29'x28' (9x8.5m) | 27'x25' (8x7.5m) |
| ASTM Use Zone | 41'x40' (13x12m) | 39'x37' (12x11m) |
| Weight | 3,155lbs (1,431kg) | 2,216lbs (1,005kg) |
| ADA Requires | 0 ground level components | 0 ground level components |



\$12,528
as shown (3.5")



Unit #16530

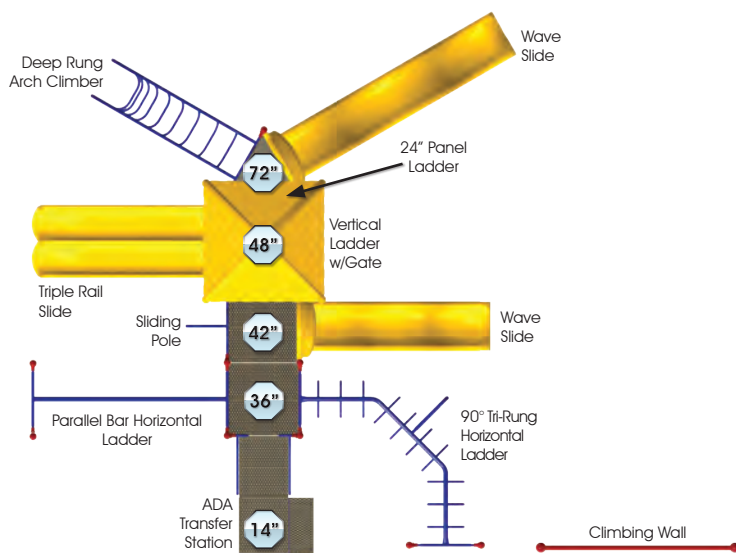

9 Play Events Featuring:

- Wave Slide (x2)
- Triple Rail Slide
- Climbing Wall
- Sliding Pole
- Vertical Ladder with Gate
- 90° Tri-Rung H. Ladder
- Parallel Bar H. Ladder
- Deep Rung Arch Climber



| Unit Number | PS5-16530 | PS3-16530 |
|----------------|--------------------------|--------------------------|
| Unit Price | \$15,146 | \$12,528 |
| Child Capacity | 30 | 25 |
| Actual Size | 31'x25' (9x8m) | 29'x23' (9x7m) |
| ASTM Use Zone | 43'x37' (14x11m) | 41'x35' (13x10m) |
| Weight | 2,877lbs (1,305kg) | 2,312lbs (1,048kg) |
| ADA Requires | 1 ground level component | 1 ground level component |

For Ages
5 to 12

\$13,752
as shown (5")



This structure is not ADA compliant as shown. Contact us to see how we can modify this design to fit your needs.

Unit #18249

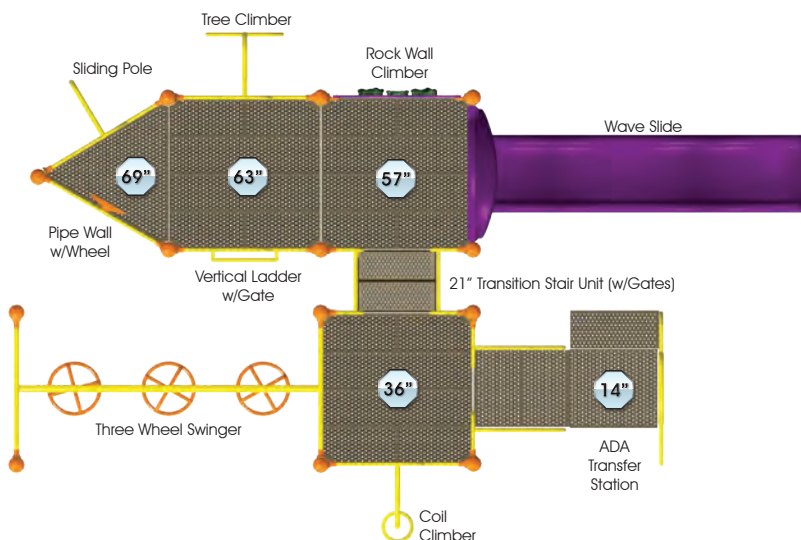

7 Play Events Featuring:

- Sliding Pole
- Tree Climber
- Rock Wall Climber
- Wave Slide
- Three Wheel Swinger
- Pipe Wall w/Wheel
- Vertical Ladder

EXPEDITION
SERIES

ADVENTURE
SERIES

| Unit Number | PS5-18249 | PS3-18249 |
|----------------|---------------------------------------|-------------------|
| Unit Price | \$13,752 | \$11,682 |
| Child Capacity | 34 | 27 |
| Actual Size | 22'x15' (7x5m) | 20'x9' (6x3m) |
| ASTM Use Zone | 34'x27' (10x8m) | 32'x21' (10x6.5m) |
| Weight | 2,467lbs (1,119kg) | 1,864lbs. (845kg) |
| ADA Requires | Does Not Meet ADA Guidelines As Shown | |



\$10,334
as shown (5")



This structure is not ADA compliant as shown.
Contact us to see how we can modify this design to fit your needs.

Unit #24960

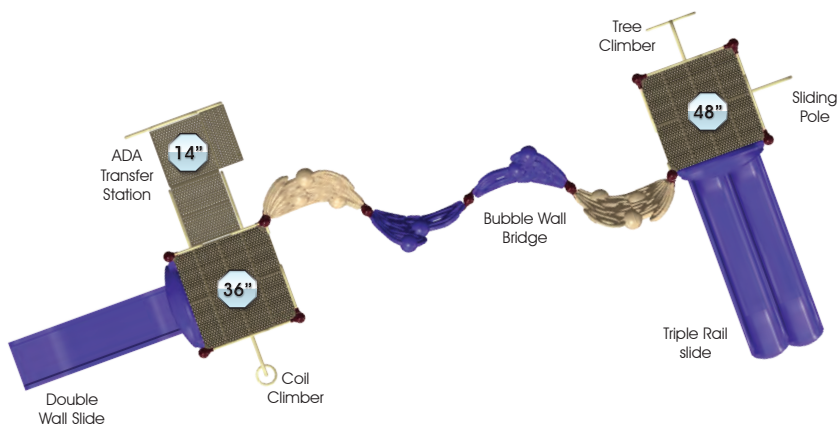

6 Play Events Featuring:

- Triple Rail Slide
- Tree Climber
- Coil Climber
- Sliding Pole
- Bubble Wall Bridge
- Double Wall Slide



| Unit Number | PS5-24960 | PS3-24960 |
|----------------|---------------------------------------|-------------------|
| Unit Price | \$10,334 | \$9,459 |
| Child Capacity | 26 | 24 |
| Actual Size | 33'x17' (10x5m) | 32'x17' (12x6m) |
| ASTM Use Zone | 45'x29' (14x9m) | 44'x29' (15x9m) |
| Weight | 1,989lbs. (902kg) | 1,223lbs. (555kg) |
| ADA Requires | Does Not Meet ADA Guidelines As Shown | |

For Ages
5 to 12

\$7,821
as shown (3.5")



Unit #16587

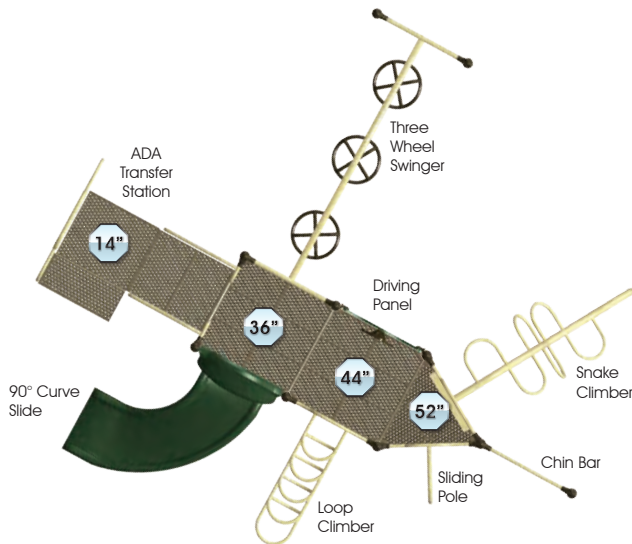

7 Play Events Featuring:

- 90° Curve Slide
- Snake Climber
- Sliding Pole
- Driving Panel
- Loop Climber
- 3-Wheel Swinger
- Chin Bar



| Unit Number | PS5-16587 | PS3-16587 |
|----------------|--------------------------|--------------------------|
| Unit Price | \$9,762 | \$7,821 |
| Child Capacity | 25 | 22 |
| Actual Size | 17'x21' (5x6.5m) | 15'x17' (4.5x5m) |
| ASTM Use Zone | 29'x33' (9x10m) | 27'x29' (8x9m) |
| Weight | 1,708lbs. (775kg) | 1,261lbs. (572kg) |
| ADA Requires | 1 ground level component | 1 ground level component |

For Ages
5 to 12

\$41,748
5" Only



The posts used in this unit are made from recycled plastic.



Unit #RP5-20481

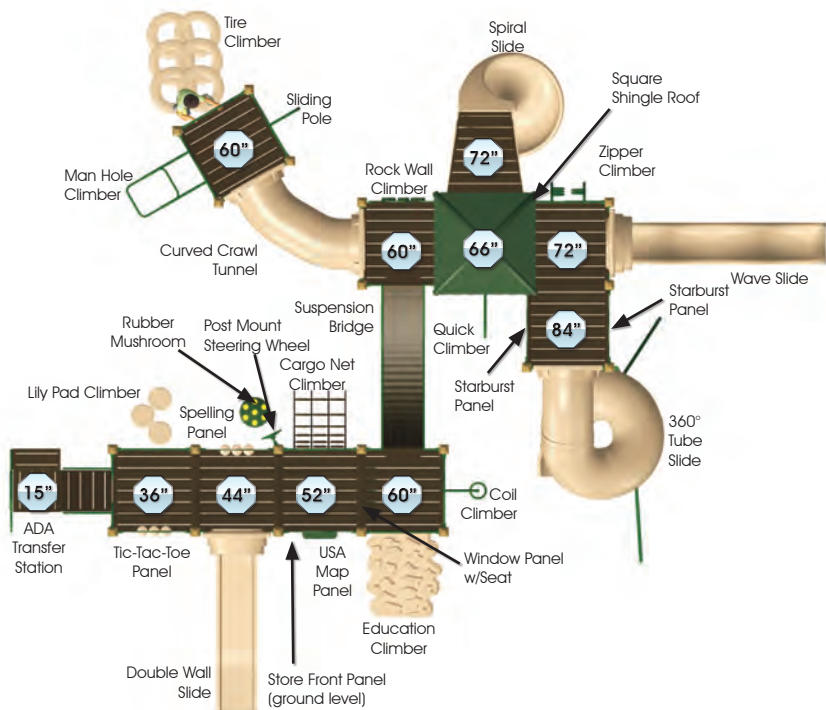

23 Play Events Featuring:

- Spelling Panel
- Store Front Panel
- Tic-Tac-Toe Panel
- Spiral Slide
- Sliding Pole
- Zipper Climber
- Coil Climber
- Tire Climber
- Man Hole Climber
- Rock Wall Climber
- USA Map Panel
- Quick Climber
- Lily Pad Climber
- Double Wall Slide
- Wave Slide
- 360° Tube Slide
- 60" Crawl Tunnel
- Rubber Mushroom
- Cargo Net Climber
- Suspension Bridge
- Education Climber
- Window Panel w/Seat
- Post Mount Steering Wheel



| Unit Number | RP5-20481 |
|----------------|---------------------------|
| Unit Price | \$41,748 |
| Child Capacity | 70 |
| Actual Size | 40'x35' (12x10.5m) |
| ASTM Use Zone | 52'x47' (16x14m) |
| Weight | 5,996lbs. (2,719kg) |
| ADA Requires | 0 ground level components |



The posts used in this unit are made from recycled plastic.



\$28,437
5" Only



Unit #RP5-24076

12 Play Events Featuring:

- Spiral Slide
- Pipe Wall w/Wheel
- Half Gear Panel
- Bubble Ladder
- Quick Climber
- Lily Pad Climber
- Wave Slide
- Track Ride
- Vertical Ladder
- Window Panel w/Seat
- Education Climber
- Inch Worm Bridge

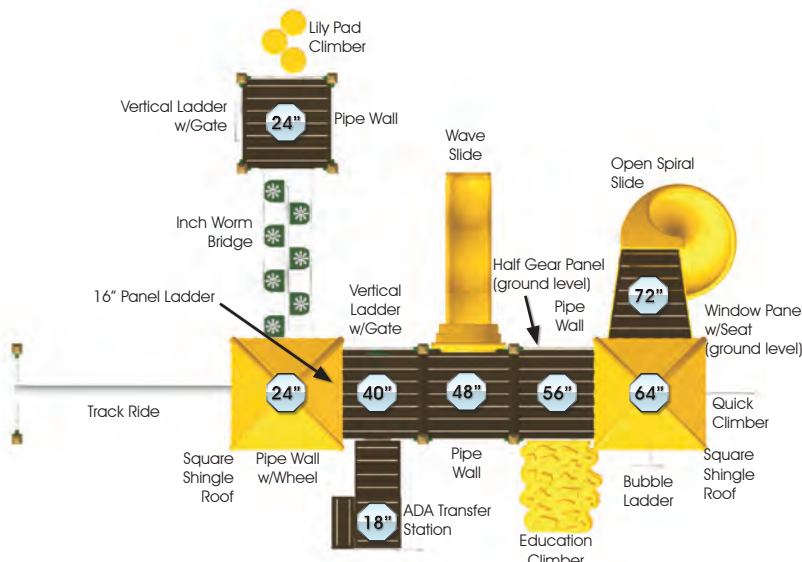

| Unit Number | RP5-24076 |
|----------------|---------------------------|
| Unit Price | \$28,437 |
| Child Capacity | 47 |
| Actual Size | 33'x22' (10x7m) |
| ASTM Use Zone | 45'x34' (14x10.5m) |
| Weight | 3,850lbs. (1,746kg) |
| ADA Requires | 0 ground level components |

For Ages
5 to 12

\$17,396
5" Only



The posts used in this unit are made from recycled plastic.



Unit #RP5-20472

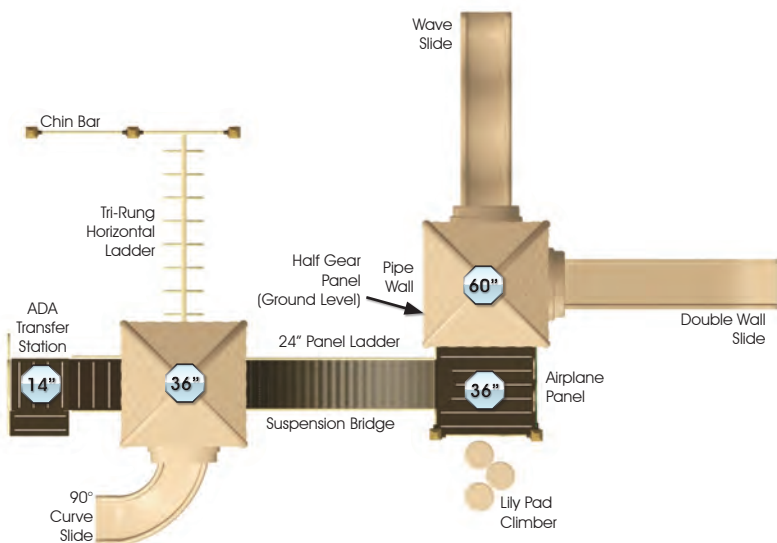

9 Play Events Featuring:

- Chin Bar
- Suspension Bridge
- Half Gear Panel
- Airplane Panel
- Lily Pad Climber
- Double Wall Slide
- Wave Slide
- 90° Curve Slide
- Tri-Rung Horizontal Ladder



| Unit Number | RP5-20472 |
|----------------|---------------------------|
| Unit Price | \$17,396 |
| Child Capacity | 32 |
| Actual Size | 31'x21' (9.5x6.5m) |
| ASTM Use Zone | 43'x33' (13x10m) |
| Weight | 2,796lbs. (1,268kg) |
| ADA Requires | 0 ground level components |

We've Been to School on PreSchool

For Ages

2 to 5

The focus for this age group is on social interaction; activities that make for great group fun, with just the right level of physical challenge. Activity panels, slides, climbers and swings all meet or exceed ASTM and IPEMA safety guidelines for this age group.

The 2 to 5 age group requires guard rails and barriers at much lower deck heights than the older age group. Deck heights for horizontal ladder launches can only be 18" high. The height of the horizontal ladder itself can not exceed 60" from the surfacing.

Playland proudly offers the Kidscenter™ line for the ages of 2-5. These units are packed with fun and are great for the budget-minded consumer. Offering 3 models starting at \$2,357, KidsCenter™ puts play value back in your playground.

We also offer our modular Expedition (5") and Adventure (3.5") series structures for ages 2-5. Pick from one of our many catalog units, or allow us to design one to fit your needs.

You may also choose to go green with one of our recycled series structures using posts made from 100% recycled milk jug plastic.



- KidsCenters™ **Page 36**
- Toddler Maze **Page 38**
- Playland Express **Page 39**
- Steel Modular Playstructures **Page 40**
- Recycled Playstructures **Page 46**



\$5,841

KidsCenter™



KidsCenter™ #5

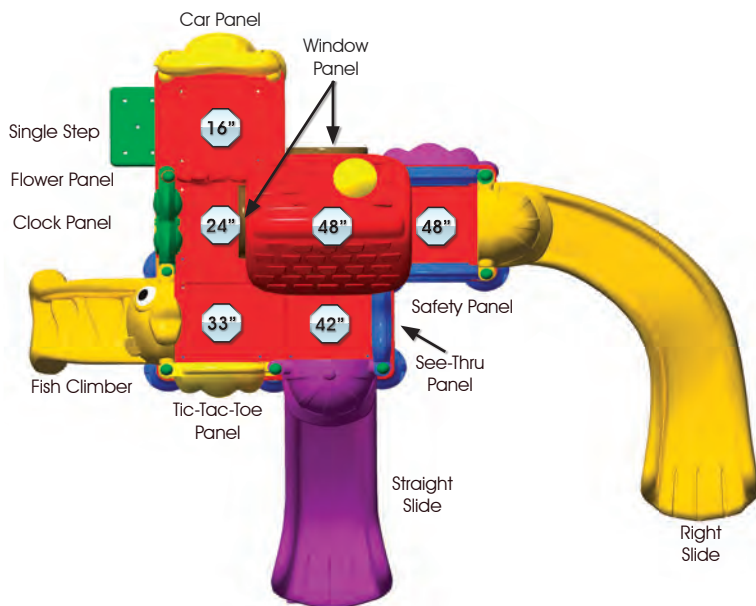

10 Play Events Featuring:

- Tic-Tac-Toe Panel
- Fish Climber
- Right Turn Slide
- Clock Panel
- Window Panel (x2)
- Car Panel
- See-Thru Panel
- Straight Slide
- Safety Panel

These units are sold as shown and cannot be modified. Colors are available as shown only.

| Unit Number | KID-05 |
|----------------|---------------------------|
| Unit Price | \$5,841 |
| Child Capacity | 22 |
| Actual Size | 19'x16' (6x5m) |
| ASTM Use Zone | 31'x28' (9.5x8.5m) |
| CPSC Use Zone | 31'x29' (9.5x9m) |
| Overall Height | 11' (3.5m) |
| Weight | 1,580 lbs. (716 kg) |
| ADA Requires | 2 ground level components |



KidsCenter™ #4



KidsCenter™ #3

8 Play Events Featuring:

- Tic-Tac-Toe Panel
- Fish Climber
- Clock Panel
- Window Panel
- See-Thru Panel
- Straight Slide

These units are sold as shown and cannot be modified.
Colors are available as shown only.

| Unit Number | KID-04 |
|----------------|---------------------------|
| Unit Price | \$4,542 |
| Child Capacity | 20 |
| Actual Size | 16'x12' (5x3.5m) |
| ASTM Use Zone | 28'x23' (8.5x7.5m) |
| Overall Height | 10.5' (3.2m) |
| Weight | 1,100 lbs. (498 kg) |
| ADA Requires | 3 ground level components |

6 Play Events Featuring:

- Tic-Tac-Toe Panel
- Fish Climber
- Clock Panel
- Window Panel
- See-Thru Panel
- Straight Slide

These units are sold as shown and cannot be modified.
Colors are available as shown only.

| Unit Number | KID-03 |
|----------------|-------------------|
| Unit Price | \$2,593 |
| Child Capacity | 14 |
| Actual Size | 11'x11' (4x4m) |
| ASTM Use Zone | 23'x23' (7x7m) |
| CPSC Use Zone | 23'x23' (7x7m) |
| Overall Height | 7.75' (2.4m) |
| Weight | 689 lbs. (312 kg) |
| ADA Requires | Does not meet ADA |

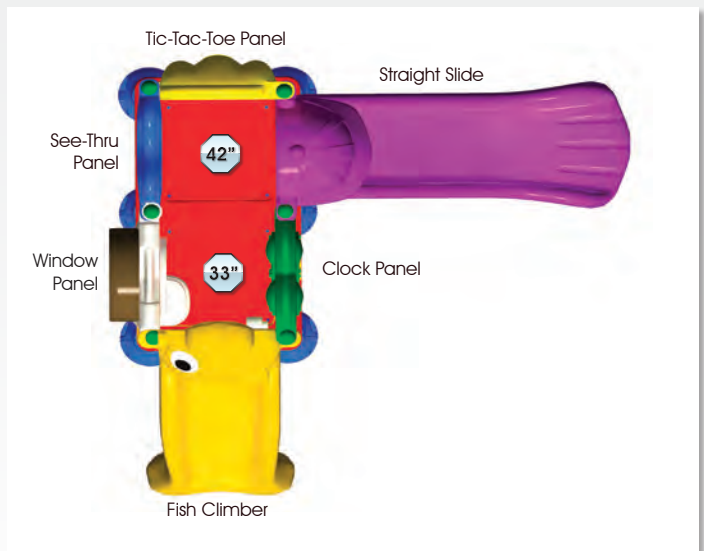
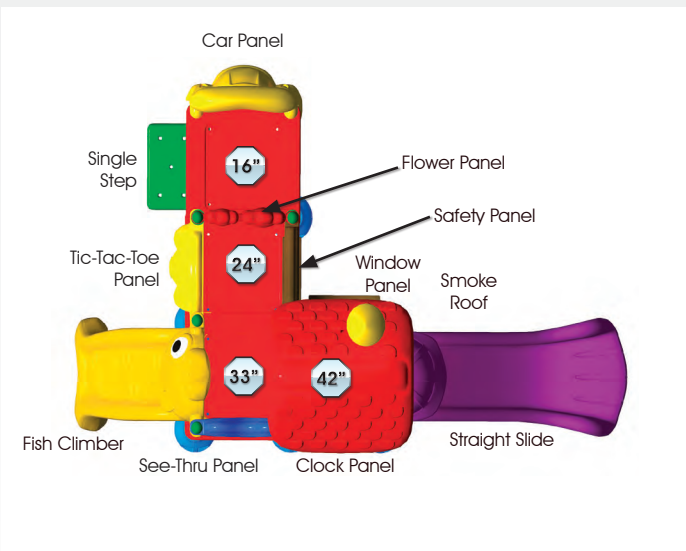

For Ages
2 to 5

\$6,030

NEW!



Unit #26833

8 Play Events Featuring:

- Dinosaur Panel
- Bubble Panel
- Crawl Through Panel
- Airplane Panel
- Gear Panel
- Window Panel

Unit Number PS3-26833

| | |
|----------------|-------------------|
| Unit Price | \$6,030 |
| Child Capacity | 16 |
| Actual Size | 7'x6' (2x2m) |
| ASTM Use Zone | 7'x6' (2x2m) |
| Weight | 640 lbs. (290 kg) |
| ADA Requires | Does not meet ADA |

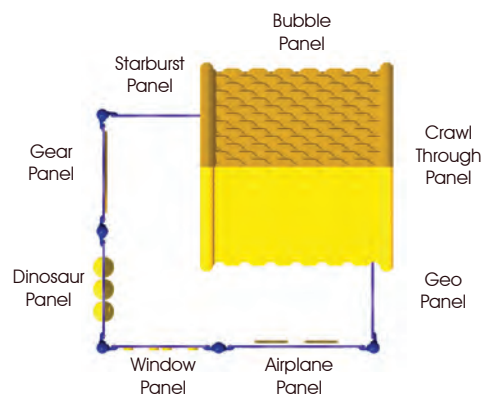

For Ages
2 to 5

\$4794

NEW!



Unit #26834

8 Play Events Featuring:

- Tic-Tac-Toe Panel
- Bubble Panel
- Crawl Through Panel
- Honey Bee
- Gear Panel
- Store Front Panel

Unit Number PS3-26834

| | |
|----------------|-------------------|
| Unit Price | \$4,794 |
| Child Capacity | 14 |
| Actual Size | 6'x6' (2x2m) |
| ASTM Use Zone | 6'x6' (2x2m) |
| Weight | 509 lbs. (231 kg) |
| ADA Requires | Does not meet ADA |

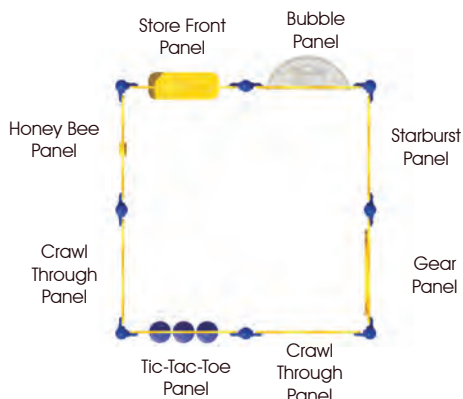



\$12,692



Unit #TEX09167

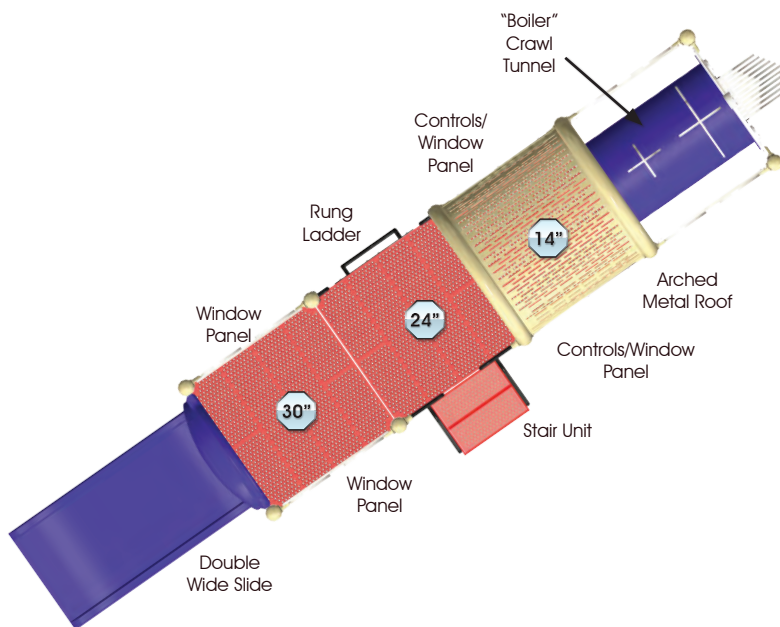

6 Play Events Featuring:

- Crawl Tube
- Double Wide Slide
- Rung Ladder
- Train Control Panels

This unit is sold as shown and cannot be modified. See page 135 for color selection.

| Unit Number | TEX09167 |
|----------------|-------------------|
| Unit Price | \$12,692 |
| Child Capacity | 27 |
| Actual Size | 24'x6' (7x2m) |
| ASTM Use Zone | 36'x18' (11x5.5m) |
| Weight | 2100 lbs. (953kg) |
| ADA Requires | Does not meet ADA |



\$25,635
as shown (3.5")



Unit #25011

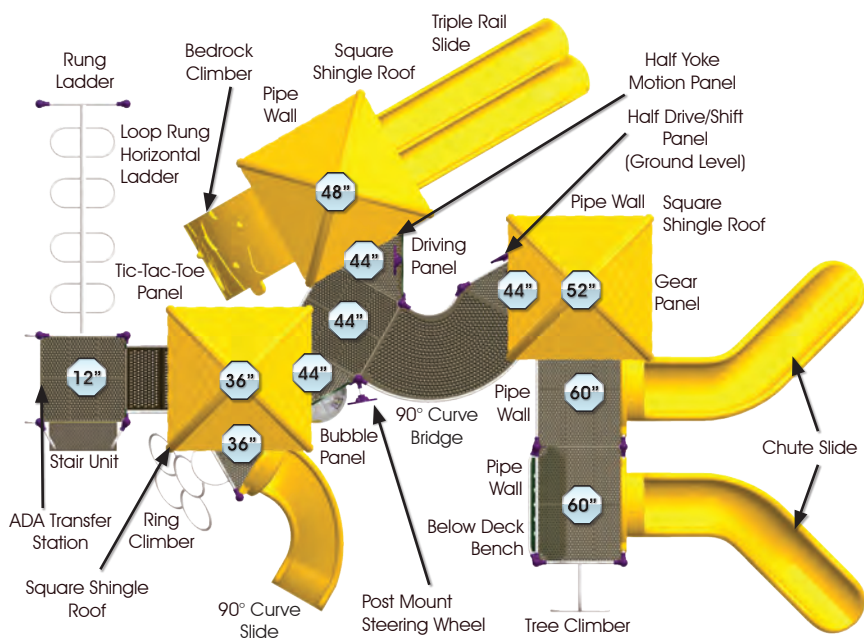

17 Play Events Featuring:

- Bedrock Climber
- Bubble Panel
- Driving Panel
- Tic-Tac-Toe Panel
- Gear Panel
- Chute Slide (x2)
- Post Mt. Steering Wheel
- Tree Climber
- Below Deck Bench
- Rung Ladder
- Loop Rung
- Horizontal Ladder
- Ring Climber
- Half Driving Panel
- Half Yoke Motion Panel
- 90° Curve Slide
- Triple Rail Slide



| Unit Number | PS5-25011 | PS3-25011 |
|----------------|---------------------------|---------------------------|
| Unit Price | \$31,676 | \$25,635 |
| Child Capacity | 56 | 38 |
| Actual Size | 35'x23' (10.5x7m) | 30'x22' (9x7m) |
| ASTM Use Zone | 47'x35' (14x10.5m) | 42'x34' (13x10m) |
| Weight | 5,205lbs (2,361kg) | 3,868lbs (1,755kg) |
| ADA Requires | 0 ground level components | 0 ground level components |

For Ages
2 to 5

\$17,383
5" Only



Unit #26861

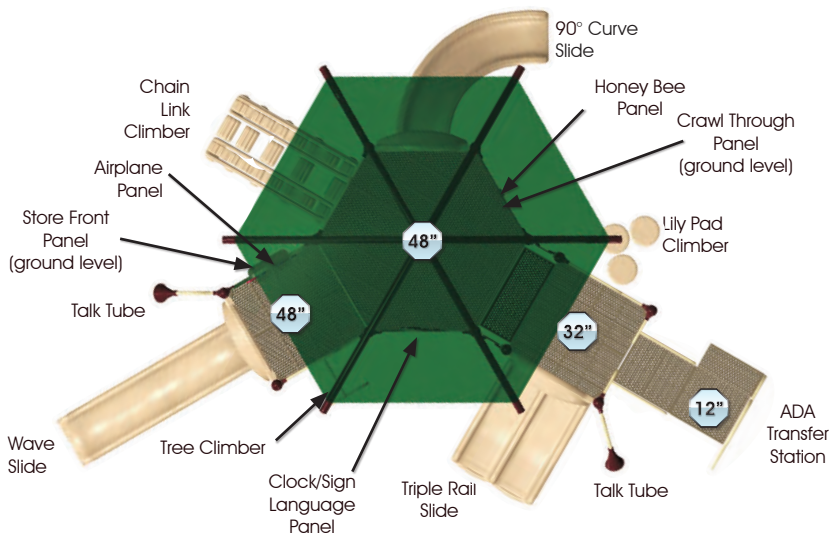

14 Play Events Featuring:

- Talk Tube
- Triple Rail Slide
- Clock/Sign Language Panel
- Tree Climber
- Crawl Through Panel
- Wave Slide
- Store Front Panel
- Airplane Panel
- Chain Link Climber
- 90° Curve Slide
- Honey Bee Panel
- Lily Pad Climber



| Unit Number | PS5-26861 |
|----------------|---------------------------|
| Unit Price | \$17,383 |
| Child Capacity | 42 |
| Actual Size | 22'x24' (7x7m) |
| ASTM Use Zone | 34'x36' (10x10.5m) |
| Weight | 2,287lbs (1,037kg) |
| ADA Requires | 0 ground level components |



\$12,854
as shown (3.5")



Unit #21162

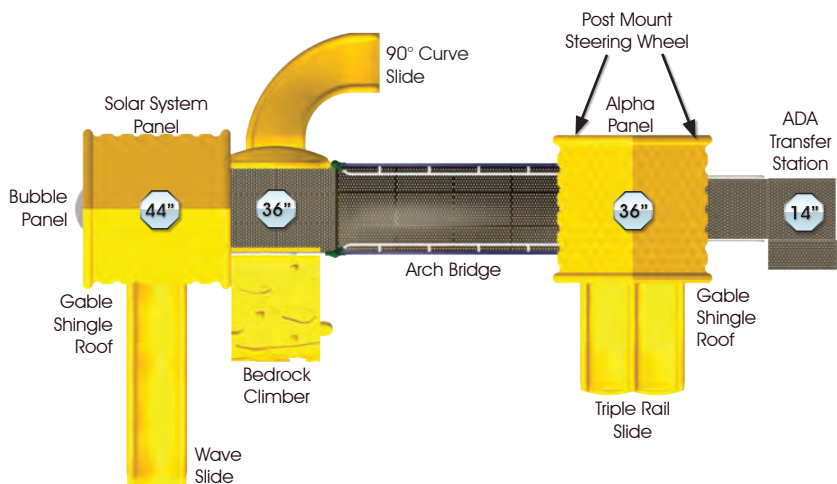

9 Play Events Featuring:

- 90° Curve Slide
- Wave Slide
- Triple Rail Slide
- Bedrock Climber
- Solar System Panel
- Bubble Panel
- Alpha Panel
- Post Mount Steering Wheel (x2)
- Arch Bridge



| Unit Number | PS5-21162 | PS3-21162 |
|----------------|---------------------------|---------------------------|
| Unit Price | \$14,594 | \$12,854 |
| Child Capacity | 30 | 28 |
| Actual Size | 26'x16' (8x5m) | 26'x15' (8x5m) |
| ASTM Use Zone | 38'x28' (12x9m) | 38'x27' (12x9m) |
| Weight | 2,436lbs (1,105kg) | 1,859lbs (567kg) |
| ADA Requires | 0 ground level components | 0 ground level components |

For Ages
2 to 5

\$10,942
as shown (3.5")



Unit #26298

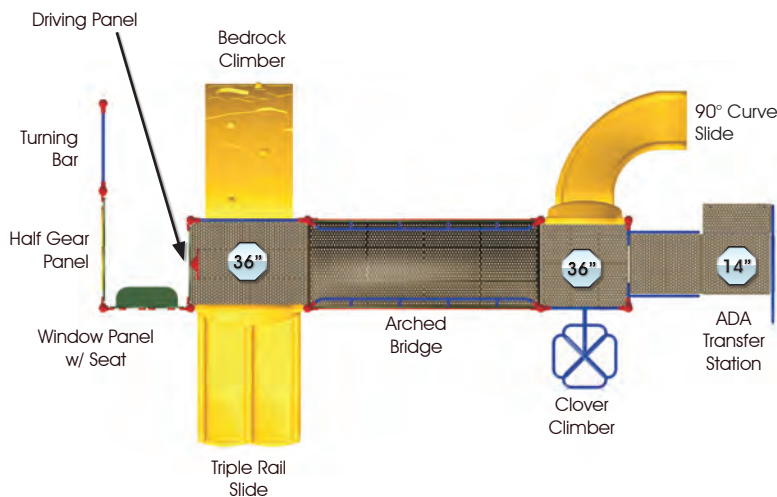

9 Play Events Featuring:

- Bedrock Climber
- Triple Rail Slide
- 90° Curve Slide
- Turning Bar
- Clover Climber
- Arched Bridge
- 1/2 Gear Panel
- Driving Panel
- Window Panel w/ Seat



| Unit Number | PS5-26298 | PS3-26298 |
|----------------|---------------------------|---------------------------|
| Unit Price | \$12,493 | \$10,942 |
| Child Capacity | 26 | 23 |
| Actual Size | 21'x13' (6x4m) | 20'x13' (6x4m) |
| ASTM Use Zone | 33'x25' (10x8m) | 32'x25' (10x8m) |
| Weight | 1,964lbs (891kg) | 1,694lbs (768kg) |
| ADA Requires | 0 ground level components | 0 ground level components |

For Ages
2 to 5

\$9,389
as shown (3.5")



Unit #12032

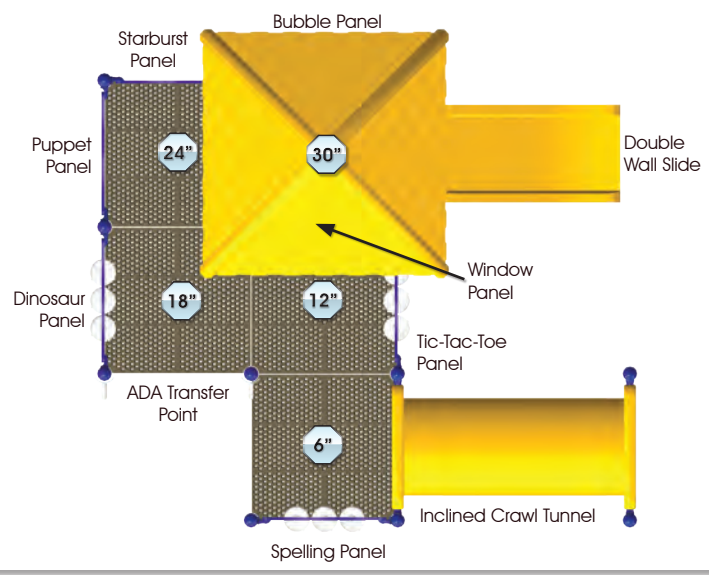

9 Play Events Featuring:

- Incline Crawl Tunnel
- Double Wall Slide
- 90° Curve Slide
- Dinosaur Panel
- Bubble Panel
- Puppet Panel
- Spelling Panel
- Tic-Tac-Toe Panel
- Window Panel



| Unit Number | PS5-12032 | PS3-12032 |
|----------------|--------------------------|--------------------------|
| Unit Price | \$12,351 | \$9,389 |
| Child Capacity | 32 | 26 |
| Actual Size | 17'x14' (5x4m) | 11'x11' (3x3m) |
| ASTM Use Zone | 29'x26' (7x7m) | 23'x23' (7x7m) |
| Weight | 1,955lbs (887kg) | 1,240lbs (563kg) |
| ADA Requires | 1 ground level component | 1 ground level component |

For Ages
2 to 5

\$28,280
5" Only



The posts used in this unit are made from recycled plastic.



Unit #RP5-20473

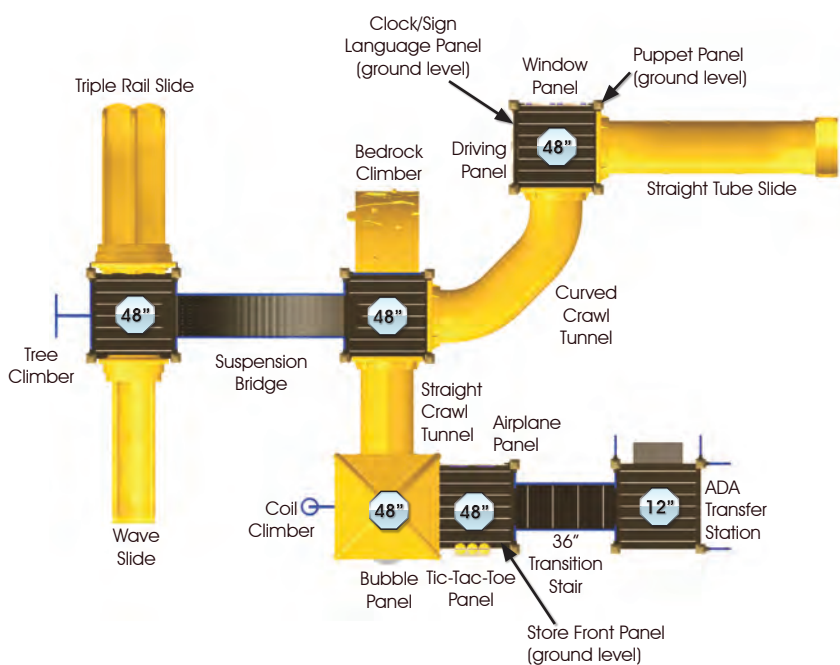

17 Play Events Featuring:

- Bubble Panel
- Driving Panel
- Puppet Panel
- Store Front Panel
- Tic-Tac-Toe Panel
- Window Panel
- Tree Climber
- Coil Climber
- Suspension Bridge
- Tube Slide
- Clock/Sign Language Panel
- Airplane Panel
- Bedrock Climber
- Triple Rail Slide
- Wave Slide
- Curved Crawl Tunnel
- Straight Crawl Tunnel



| Unit Number | RP5-20473 |
|----------------|---------------------------|
| Unit Price | \$28,280 |
| Child Capacity | 52 |
| Actual Size | 37'x23' (11x7m) |
| ASTM Use Zone | 49'x35' (15x10.5m) |
| Weight | 4,002lbs. (1,815kg) |
| ADA Requires | 0 ground level components |



The posts used in this unit are made from recycled plastic.

For Ages
2 to 5

\$13,306
5" Only



Unit #RP5-21724

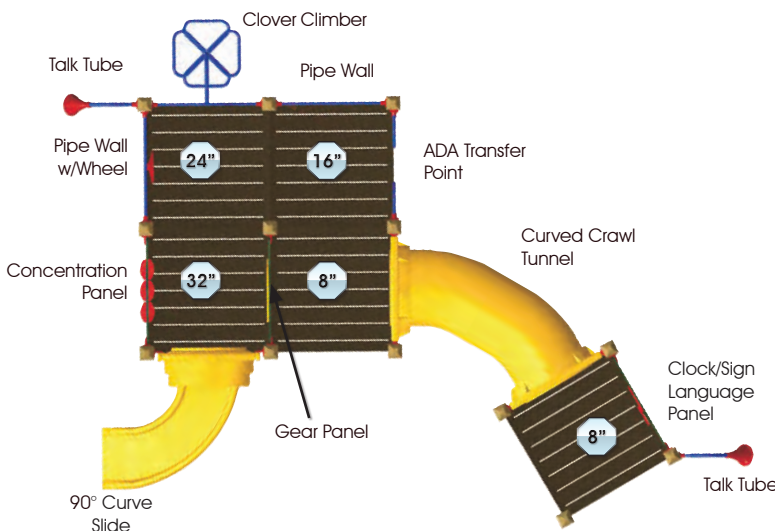

8 Play Events Featuring:

- Concentration Panel
- Gear Panel
- Pipe Wall w/Wheel
- Clover Climber
- Talk Tube
- Clock/Sign Language Panel
- 90° Curve Slide
- 60° Crawl Tunnel



| Unit Number | RP5-21724 |
|----------------|--------------------------|
| Unit Price | \$13,306 |
| Child Capacity | 26 |
| Actual Size | 22'x17' (7x5m) |
| ASTM Use Zone | 34'x29' (10x9m) |
| Weight | 1,838lbs. (854kg) |
| ADA Requires | 1 ground level component |

For Ages
2 to 5

\$10,247
5" Only



The posts used in this unit are made from recycled plastic.



Unit #RP5-22727

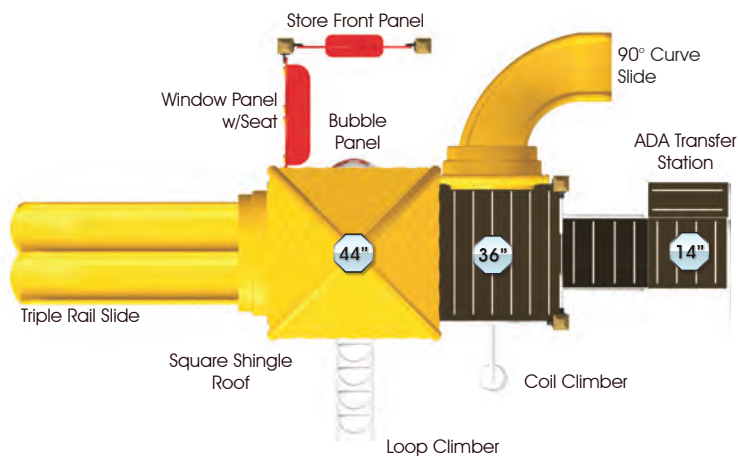

7 Play Events Featuring:

- Bubble Panel
- Store Front Panel
- Window Panel w/Seat
- Coil Climber
- Loop Climber
- Triple Rail Slide
- 90° Curve Slide



| Unit Number | RP5-22727 |
|----------------|---------------------------|
| Unit Price | \$10,247 |
| Child Capacity | 23 |
| Actual Size | 20'x13' (6x4m) |
| ASTM Use Zone | 32'x25' (10x8m) |
| Weight | 1,704lbs. (773kg) |
| ADA Requires | 0 ground level components |

Grouping components to meet the needs of a wide age group

For Ages

2 to 12

Sometimes separate playgrounds are not an option, so structures must be created and designed to meet the needs of both age groups. Here are some of the main issues when grouping components:

1. Younger children require barriers on lower decks.
2. Older children require wider slide beds.
3. Overhead ladders must be lower to accommodate younger children.

To accommodate both age groups, both sets of guidelines must be met. You must also make sure to limit use of the playground to one age group at a time or, if not possible, you must ensure there is enough supervision to create a safe environment for all the children.

Playland has comprehensive knowledge of how to put a playground together that meets the needs of the 2 to 12 age group. You design the structure; we will make sure it meets the regulations.



We offer our modular Expedition (5") and Adventure (3.5") series structures for ages 2-12. Pick from one of our many catalog units, or allow us to design one to fit your needs.

You may also choose to go green with one of our recycled series structures using posts made from 100% recycled milk jug plastic.

- Steel Modular Playstructures **Page 50**
- Recycled Playstructures **Page 62**

For Ages
2 to 12

\$47,857
as shown (3.5")



Unit #23295

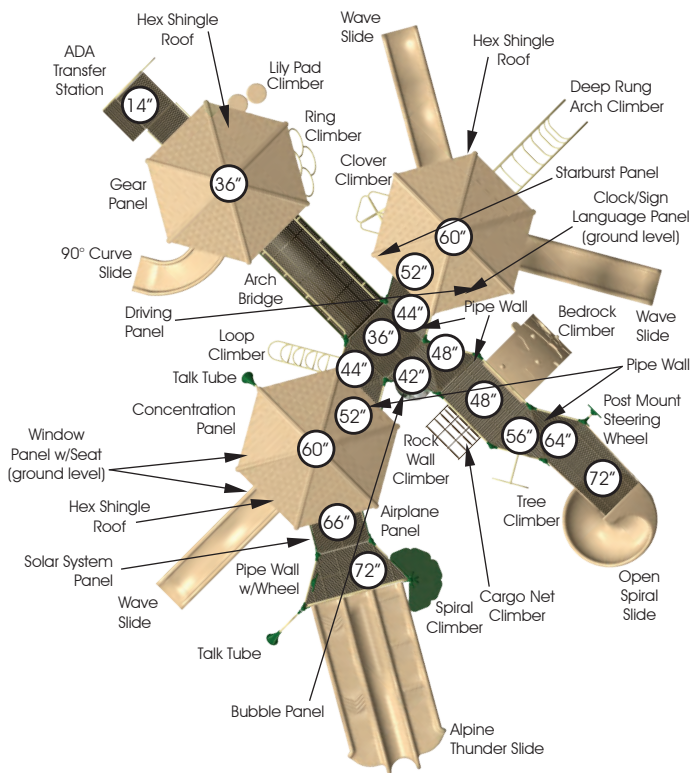

27 Play Events Featuring:

- Lily Pad Climber
- Wave Slide
- 90° Curve Slide
- Bedrock Climber
- Cargo Net Climber
- Bubble Panel
- Concentration Panel
- Driving Panel
- Crawl Thru Panel
- Gear Panel
- Window Panel w/Seat
- Spiral Slide
- Pipe Wall w/Wheel
- Pst Mt. Steering Wheel
- Deep Rung Arch
- Clover Climber
- Tree Climber
- Loop Climber
- Spiral Climber
- Talk Tube
- Alpine Thunder Slide
- Rock Wall Climber
- Airplane Panel
- Clock Panel
- Ring Climber



| Unit Number | PS5-23295 | PS3-23295 |
|----------------|---------------------------|---------------------------|
| Unit Price | \$56,664 | \$47,857 |
| Child Capacity | 98 | 82 |
| Actual Size | 42'x41' (13x12.5m) | 37'x34' (11x10m) |
| ASTM Use Zone | 54'x53'(16.5x16m) | 49'x46' (15x14m) |
| Weight | 9,018lbs (4,091kg) | 7,006lbs (3,178kg) |
| ADA Requires | 0 ground level components | 0 ground level components |

For Ages
2 to 12

\$45,841*
5" only



Design Note: Triple Rail Slide hood pictured will be replaced with our new design as seen in rendered view.

Unit #20498

22 Play Events Featuring:

- State Panel
- Lily Pad Climber
- Solar System Panel
- Half Yoke Motion Panel
- Bubble Climber
- Coil Climber
- Half Push Panel
- Half Drive Shift Panel
- Zipper Climber
- Spiral Climber
- Spanish to English Panel
- Open Spiral Slide
- Below Deck Bench
- Deep Rung Arch
- Bubble Panel
- Chute Slide
- Half Maze Panel
- Triple Rail Slide
- Honey Bee Panel
- Rung Ladder
- Loop Climber
- Inch Worm Bridge
- Single Wheel Swinger
- Airplane Panel



| Unit Number | PS5-20498 |
|----------------|---------------------------|
| Unit Price | \$45,841* |
| Child Capacity | 68 |
| Actual Size | 42'x28' (13x9m) |
| ASTM Use Zone | 53'x40' (16x12m) |
| Weight | 6,677lbs (3,024kg) |
| ADA Requires | 0 ground level components |

*Price includes modular shade roofs

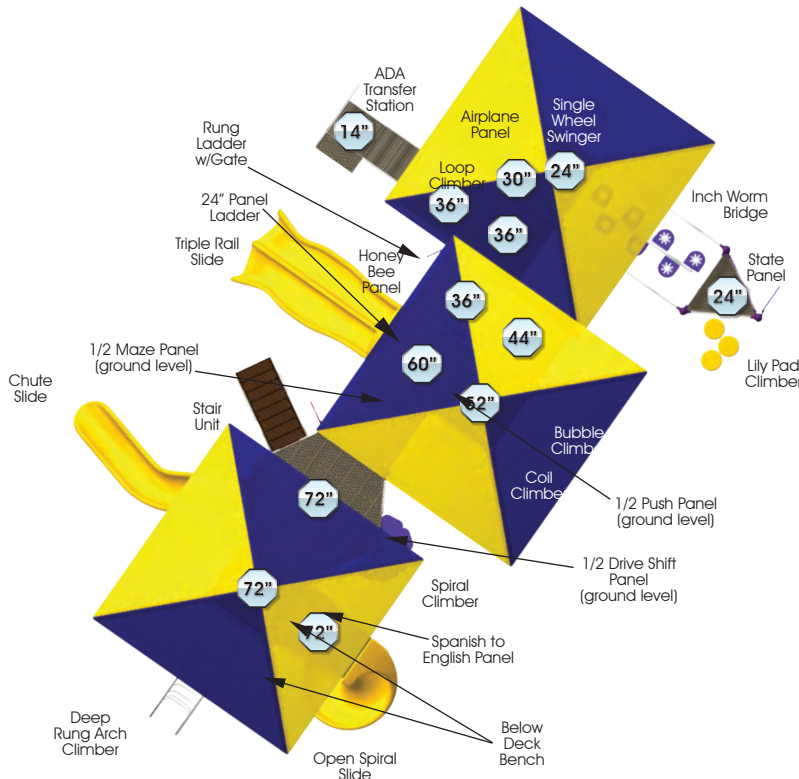



\$26,402
As Shown (5")



Unit #18245

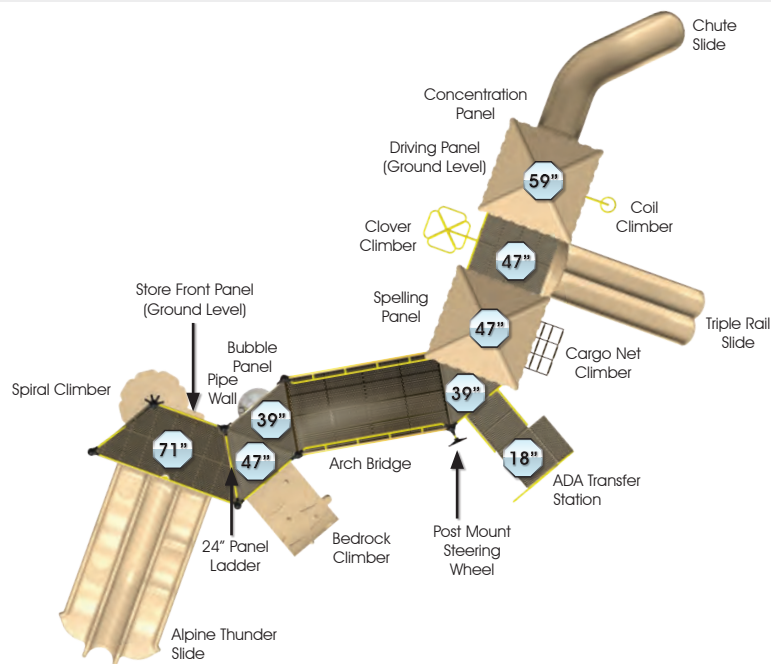

14 Play Events Featuring:

- Spiral Climber
- Alpine Thunder Slide
- Store Front Panel
- Bubble Panel
- Spelling Panel
- Clover Climber
- Concentration Panel
- Driving Panel
- Coil Climber
- Chute Slide
- Triple Rail Slide
- Cargo Net Climber
- Post Mount Steering Wheel
- Bedrock Climber



| Unit Number | PS5-18245 | PS3-18245 |
|----------------|---------------------------|---------------------------|
| Unit Price | \$26,402 | \$23,942 |
| Child Capacity | 47 | 44 |
| Actual Size | 42'x22' (13x7m) | 42'x15' (13x4.5m) |
| ASTM Use Zone | 54'x34' (16.5x10m) | 54'x27' (16.5x8.5m) |
| Weight | 4,042lbs (1,833kg) | 3,455lbs (1,567kg) |
| ADA Requires | 0 ground level components | 0 ground level components |

For Ages
2 to 12

\$21,394
As Shown (5")



Unit #23918

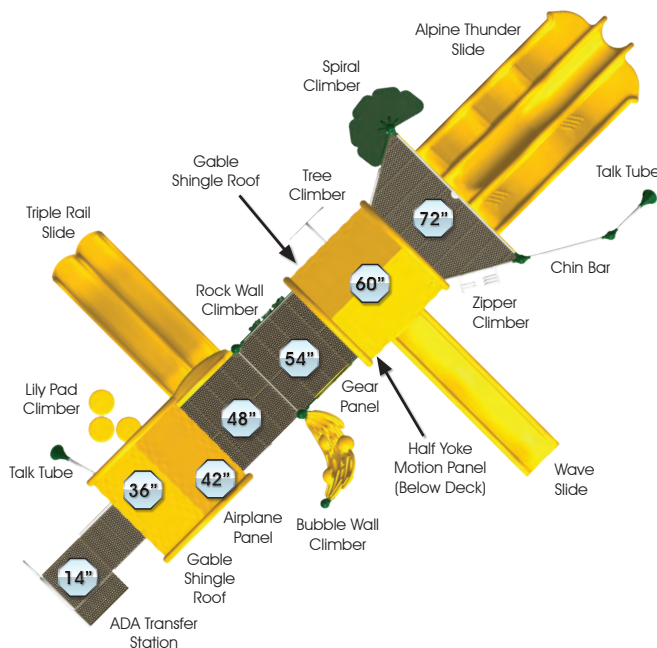

12 Play Events Featuring:

- Lily Pad Climber
- Alpine Thunder Slide
- Gear Panel
- Zipper Climber
- Tree Climber
- Spiral Climber
- Talk Tube
- Chin Bar
- Rock Wall Climber
- Airplane Panel
- Half Yoke Motion Panel
- Wave Slide
- Triple Rail Slide
- Bubble Wall Climber



| Unit Number | PS5-23918 | PS3-23918 |
|----------------|--------------------------|--------------------------|
| Unit Price | \$21,394 | \$18,422 |
| Child Capacity | 42 | 36 |
| Actual Size | 35'x21' (10.5x7m) | 30'x20' (9x6m) |
| ASTM Use Zone | 47'x33' (14x10m) | 42'x32' (13x10m) |
| Weight | 3,621lbs (1,642kg) | 2,667lbs (1,110kg) |
| ADA Requires | 1 ground level component | 1 ground level component |

For Ages
2 to 12

\$22,147
As Shown (5")



Unit #18209

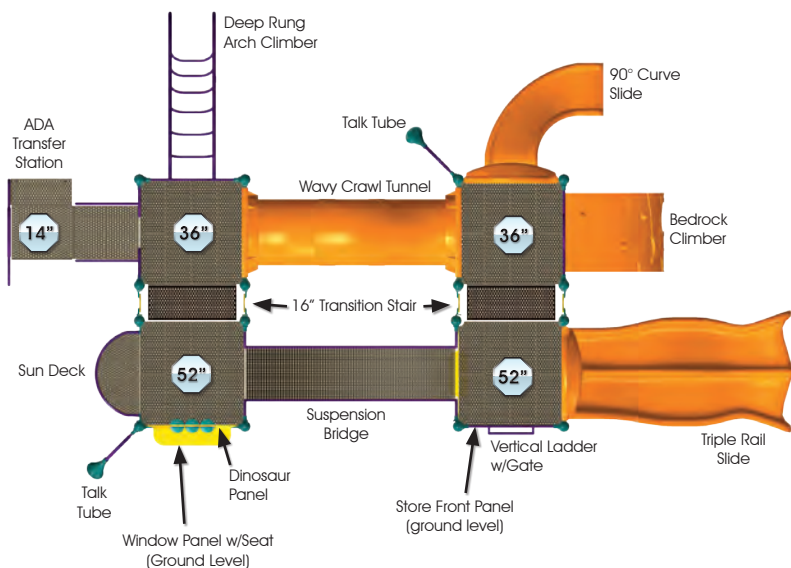

10 Play Events Featuring:

- Triple Rail Slide
- Bedrock Climber
- 90° Curve Slide
- Talk Tube
- Wavy Crawl Tunnel
- Dinosaur Panel
- Store Front Panel
- Vertical Ladder
- Window Panel w/Seat
- Deep Rung Arch Climber



| Unit Number | PS5-18209 | PS3-18209 |
|----------------|---------------------------|---------------------------|
| Unit Price | \$22,147 | \$18,808 |
| Child Capacity | 43 | 42 |
| Actual Size | 30'x18' (9x5m) | 27'x19' (8x5.6m) |
| ASTM Use Zone | 42'x30' (13x9m) | 39'x31' (12x10m) |
| Weight | 3,372lbs (1,529kg) | 2,414lbs (1,116kg) |
| ADA Requires | 0 ground level components | 0 ground level components |

For Ages
2 to 12

\$19,499
As Shown (3.5")



Design Note: Slide hoods pictured will be replaced with our new design as seen in rendered view.

Unit #23280

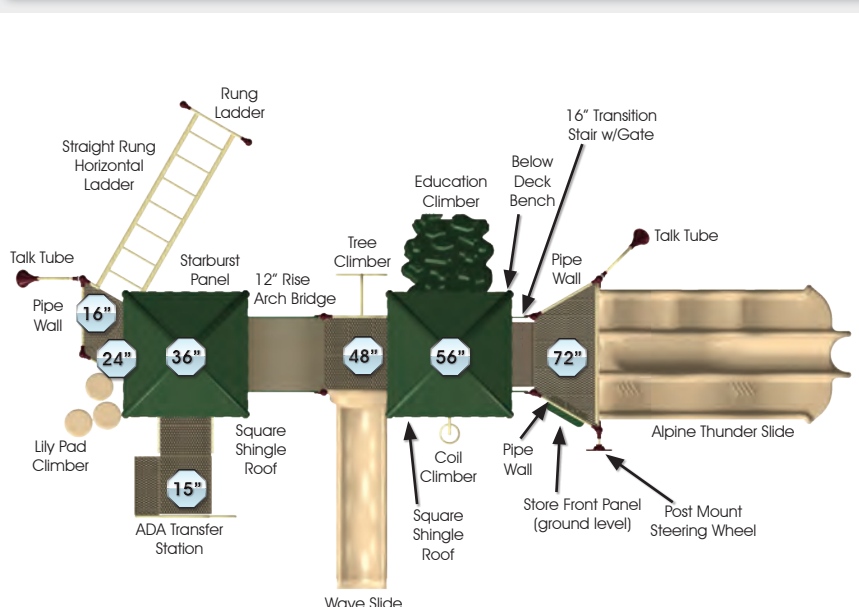

This structure is not ADA compliant as shown. Contact us to see how we can modify this design to fit your needs.

12 Play Events Featuring:

- Alpine Thunder Slide
- Talk Tube
- Education Climber
- Below Deck Bench
- Tree Climber
- Rung Ladder
- Lily Pad Climber
- Wave Slide
- Coil Climber
- Store Front Panel
- Post Mount Steering Wheel
- Straight Rung Horizontal Ladder



| Unit Number | PS5-23280 | PS3-23280 |
|----------------|---------------------------------------|---------------------|
| Unit Price | \$23,144 | \$19,499 |
| Child Capacity | 46 | 42 |
| Actual Size | 36'x21' (11x7m) | 34'x20' (11x6m) |
| ASTM Use Zone | 48'x33' (15x10m) | 46'x32' (15x10m) |
| Weight | 3,946lbs. (1,790kg) | 2,927lbs. (1,328kg) |
| ADA Requires | Does Not Meet ADA Guidelines As Shown | |



\$16,093
As Shown (3.5")



Unit #25133

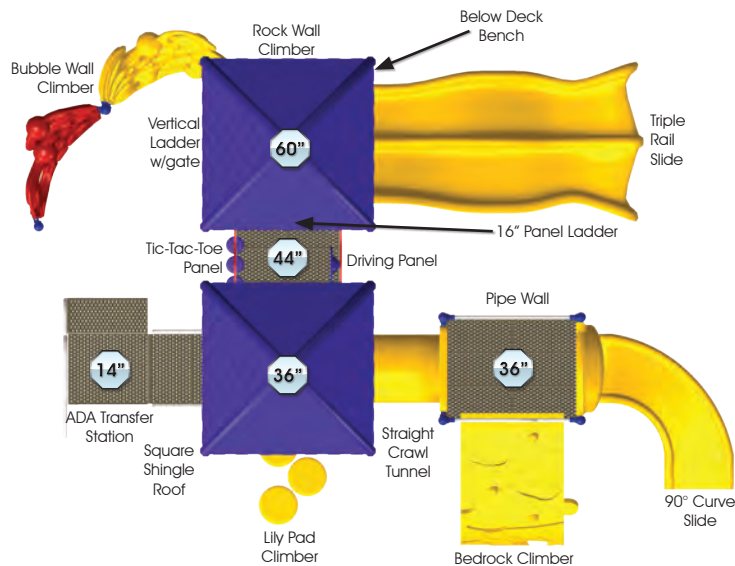

11 Play Events Featuring:

- 90° Curve Slide
- Triple Rail Slide
- Below Deck Bench
- Driving Panel
- Bedrock Climber
- Rock Wall Climber
- Vertical Ladder w/gate
- Tic-Tac-Toe Panel
- Bubble Wall Climber
- Crawl Tunnel
- Lily Pad Climber



| Unit Number | PS5-25133 | PS3-25133 |
|----------------|---------------------------|---------------------------|
| Unit Price | \$19,308 | \$16,093 |
| Child Capacity | 38 | 28 |
| Actual Size | 23'x19' (7.5x5.5m) | 21'x15' (6.5x4.5m) |
| ASTM Use Zone | 35'x31' (10.5x9.5m) | 33'x27' (10x8m) |
| Weight | 3,062lbs. (1,389kg) | 2,160lbs. (980kg) |
| ADA Requires | 2 ground level components | 2 ground level components |

For Ages
2 to 12

\$15,685
As Shown (3.5")



Design Note: Slide hoods pictured will be replaced with our new design as seen in rendered view.

Unit #12199

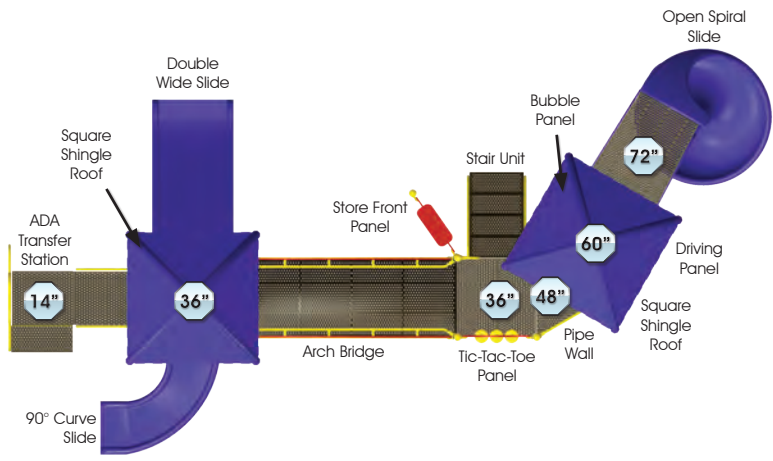

8 Play Events Featuring:

- 90° Curve Slide
- Double Wide Slide
- Open Spiral Slide
- Store Front Panel
- Bubble Panel
- Driving Panel
- Tic-Tac-Toe Panel
- Arch Bridge



| Unit Number | PS5-12199 | PS3-12199 |
|----------------|--------------------------|--------------------------|
| Unit Price | \$18,344 | \$15,685 |
| Child Capacity | 34 | 26 |
| Actual Size | 31'x17' (9x6m) | 29'x15' (9x5m) |
| ASTM Use Zone | 43'x29' (14x9m) | 41'x27' (12.5x8m) |
| Weight | 3,101lbs. (1,407kg) | 2,580lbs. (1,170kg) |
| ADA Requires | 1 ground level component | 1 ground level component |

For Ages
2 to 12

\$13,293
As Shown (3.5")



Unit #24954

This structure is not ADA compliant as shown.
Contact us to see how we can modify this design to fit your needs.

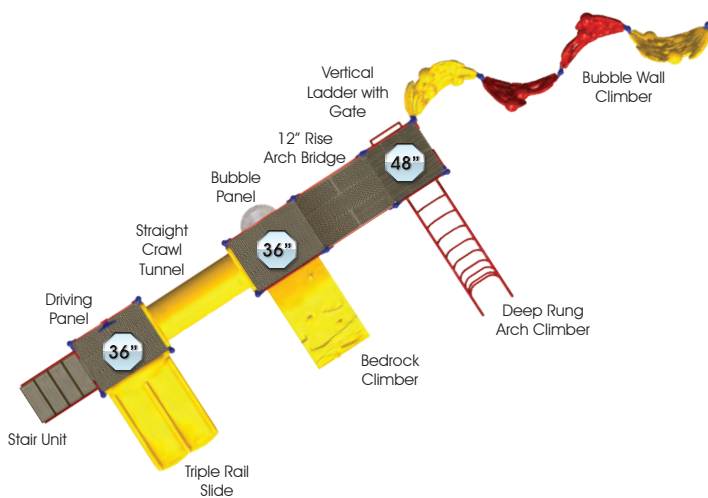

8 Play Events Featuring:

- Crawl Tunnel
- Vertical Ladder with Gate
- Bubble Panel
- Driving Panel
- Triple Rail Slide
- Bedrock Climber
- Bubble Wall Climber
- Deep Rung Arch Climber



| Unit Number | PS5-24954 | PS3-24954 |
|----------------|---------------------------------------|-------------------|
| Unit Price | \$15,516 | \$13,293 |
| Child Capacity | 36 | 32 |
| Actual Size | 41x12' (12.5x3.5m) | 38'x10' (11.5x3m) |
| ASTM Use Zone | 53'x24' (16x7m) | 50'x22' (15x7m) |
| Weight | 2,456lbs. (1,114kg) | 1,616lbs. (733kg) |
| ADA Requires | Does Not Meet ADA Guidelines As Shown | |

For Ages
2 to 12

\$11,848
As Shown (3.5")



Unit #18797

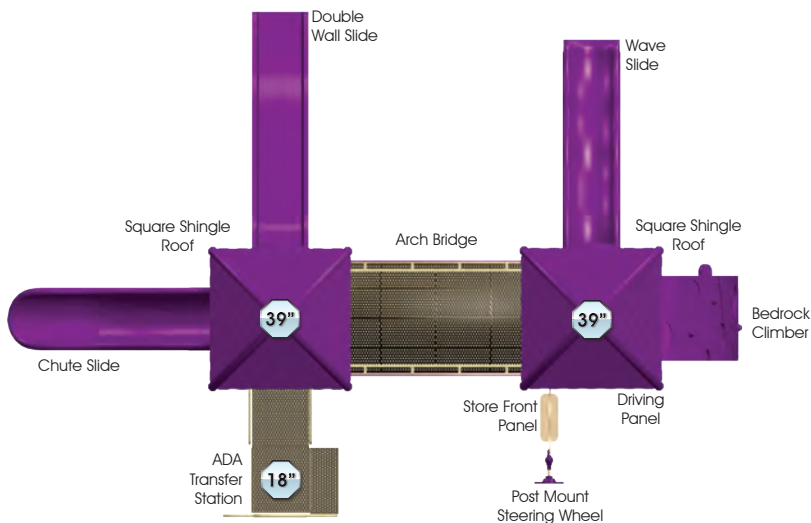

8 Play Events Featuring:

- Bedrock Climber
- Driving Panel
- Store Front Panel
- Post Mount Steering Wheel
- Arch Bridge
- Chute Slide
- Double Wall Slide
- Wave Slide



| Unit Number | PS5-18797 | PS3-18797 |
|----------------|---------------------------|---------------------------|
| Unit Price | \$13,505 | \$11,848 |
| Child Capacity | 26 | 24 |
| Actual Size | 28'x18' (9x5m) | 26'x18' (8x5m) |
| ASTM Use Zone | 40'x30' (13x10m) | 38'x30' (11.5x9m) |
| Weight | 2,109lbs. (956kg) | 1,775lbs. (805kg) |
| ADA Requires | 0 ground level components | 0 ground level components |

For Ages
2 to 12

\$8,978
As Shown (3.5")



Unit #25037

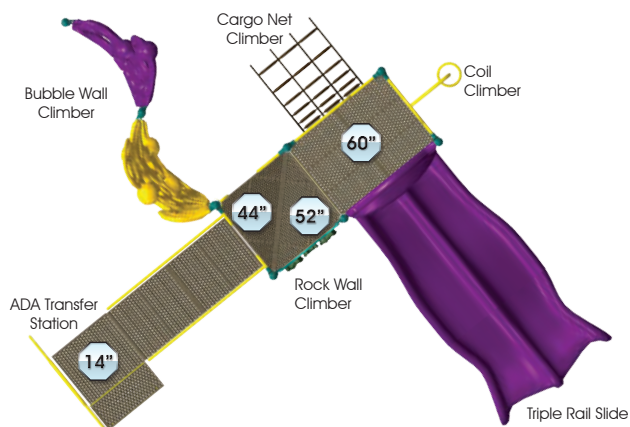

5 Play Events Featuring:

- Cargo Net Climber
- Coil Climber
- Rock Wall Climber
- Triple Rail Slide
- Bubble Wall Climber



| Unit Number | PS5-25037 | PS3-25037 |
|----------------|---------------------------|---------------------------|
| Unit Price | \$10,574 | \$8,978 |
| Child Capacity | 22 | 20 |
| Actual Size | 21'x18' (6.5x5.5m) | 20'x17' (6x5m) |
| ASTM Use Zone | 33'x30' (10x9m) | 32'x29' (10x9m) |
| Weight | 1,845lbs. (562kg) | 1,203lbs. (367kg) |
| ADA Requires | 2 ground level components | 2 ground level components |

For Ages
2 to 12

\$8,554
5" Only



The posts used in this unit are made from recycled plastic.



Unit #RP5-20476

This structure is not ADA compliant as shown. Contact us to see how we can modify this design to fit your needs.

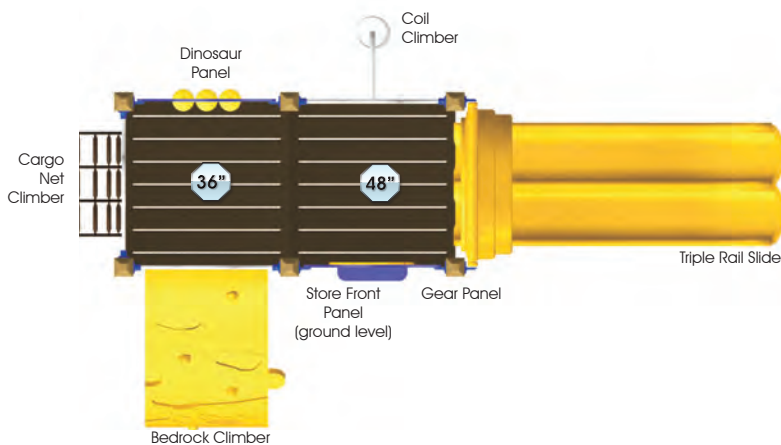

7 Play Events Featuring:

- Dino Panel
- Store Front Panel
- Gear Panel
- Coil Climber
- Bedrock Climber
- Cargo Net Climber
- Triple Rail Slide



| Unit Number | RP5-20476 |
|----------------|---------------------------------------|
| Unit Price | \$8,554 |
| Child Capacity | 24 |
| Actual Size | 19'x10' (6x3m) |
| ASTM Use Zone | 31'x22' (9.5x7m) |
| Weight | 1,214lbs. (551 kg) |
| ADA Requires | Does Not Meet ADA Guidelines As Shown |

For Ages
2 to 12

\$19,692
5" Only



The posts used in this unit are made from recycled plastic.

Unit #RP5-20475

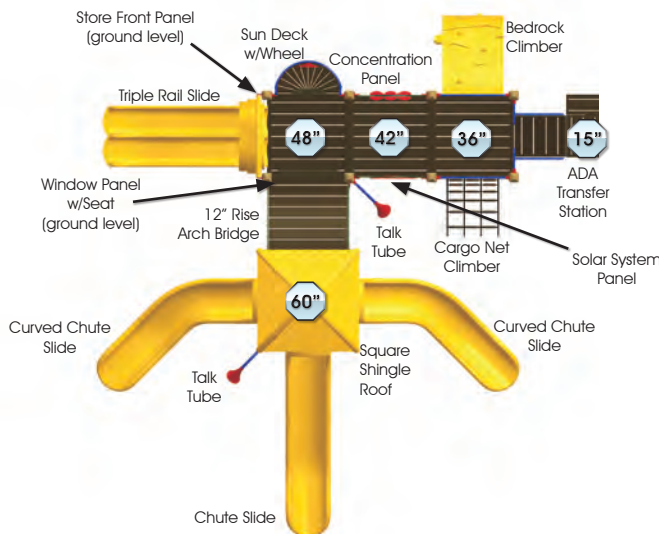

10 Play Events Featuring:

- Concentration Panel
- Store Front Panel
- Window Panel w/Seat
- Chute Slide (x3)
- Talk Tube
- Sun Deck w/Wheel
- Solar System Panel
- Bedrock Climber
- Cargo Net Climber
- Triple Rail Slide



| Unit Number | RP5-20475 |
|----------------|---------------------------|
| Unit Price | \$19,692 |
| Child Capacity | 37 |
| Actual Size | 26'x26' (8x8m) |
| ASTM Use Zone | 38'x38' (11.5x11.5m) |
| Weight | 2883lbs. (1,308kg) |
| ADA Requires | 0 ground level components |

The Soul of a Fun Machine: Playstructure Components

You can create a magnet for spirited, safe play. Choose from over 100 modular play components. Each one meets a child's high standard for **Play-on Power**. And, each meets or exceeds applicable safety standards.

Design your playground component-by-component or simply choose one of the Playground Portfolio units and customize it. You can choose from many challenging climbers and activity panels that educate and entertain, and the industry's most popular horizontal ladders, tube slides and much, much more.



- Decks [Page 65](#)
- Accessories [Page 66](#)
- Stairs/Ramps [Page 67](#)
- Bridges [Page 68](#)
- Horizontal Ladders [Page 70](#)
- Climbers [Page 72](#)
- Slides [Page 76](#)
- Tube Slides [Page 78](#)
- Crawl Tunnels [Page 79](#)
- Activity Panels/Barriers [Page 80](#)
- Roofs [Page 84](#)

Decks

Decks are made from 12 gauge hot-rolled punched steel that is plastisol coated. The perforated surface has holes that are approximately 5/8" in diameter after coating and 1.25" on center spacing between perforations.

All of our decks mount flush to one another or at offset heights to create challenge and interest. Kick plates are available for 8" and 12" offsets to meet required safety standards. See colors on [p.135](#)

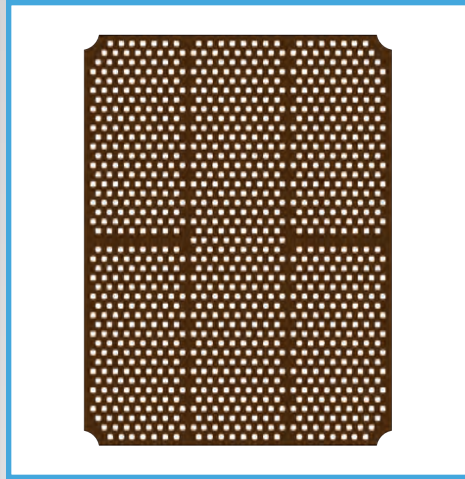

Rectangle

The Rectangle Deck is the essential piece that allows 48" grid components to be used on the 3 1/2" Adventure Series.

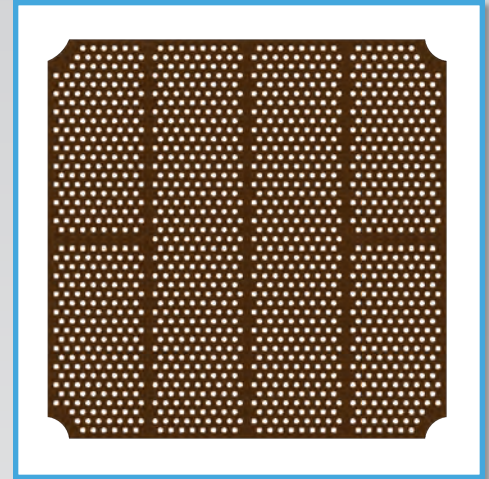

Square

The Square Deck is available for the 36" and 48" grid and is the most basic of our decks.

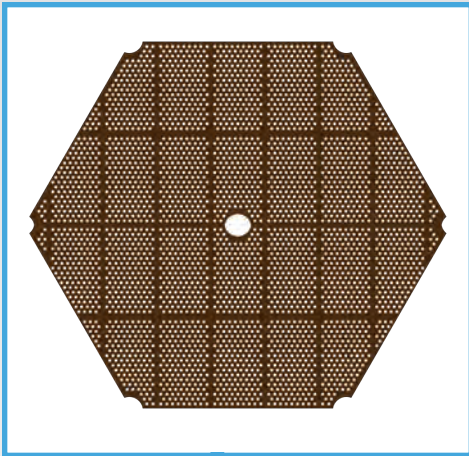

Hex

The Hex Deck is available for the 36" and 48" grid and is the equivalent of six triangle decks.

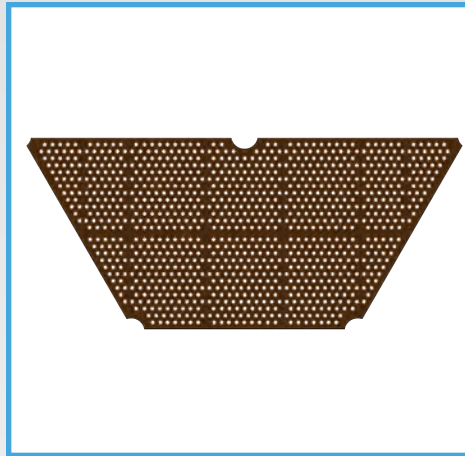

Half Hex

The Half Hex Deck is available for the 36" and 48" grid and is the equivalent of three triangle decks.

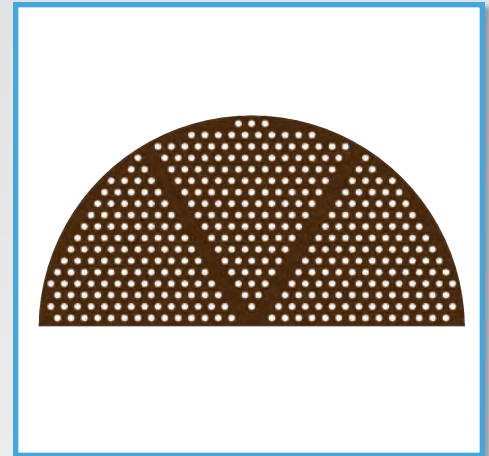

Sun

The Sun Deck is a functional way to increase deck area without the need for additional posts. 48" grid only.

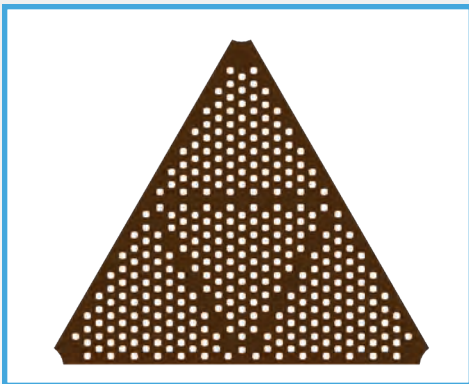

Triangle

The Triangle Deck is available for the 36" and 48" grid and is the foundation of the hex decks.

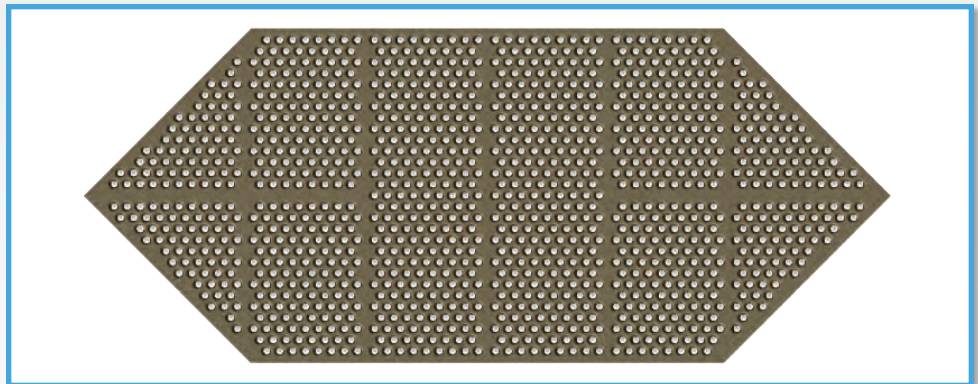

Tower

The Tower Deck is designed to allow multi-tier structures up to 9' in height. This is also available for making octagonal deck structures. 48" grid only.

Our large selection of accessories add fun and function to your Playland playstructure.

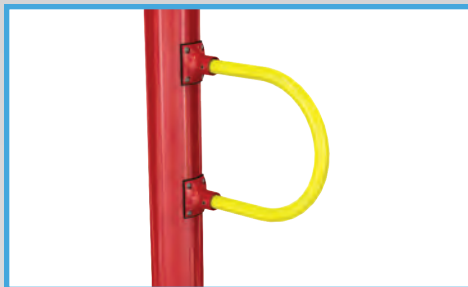

C-Grab Handle

These are a simple way to add hand support in areas where children need a helping hand.



Steering Wheel

Add fun to you play structure with this post mounted accessory.

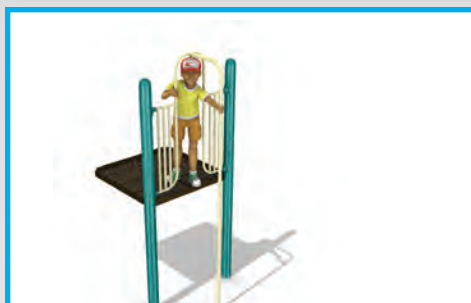

Sliding Pole

age 5^{to}12

Deck Heights: 24" - 72"

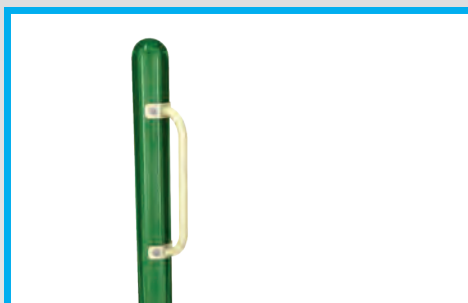

D-Grab Handle

These handles give a helping hand in tight spaces where C-Grab handles will not fit.



Chin-Up Bar

Another great outdoor gym event. Chin-ups are still one of the best ways to develop upper body strength and stamina. Lower bars can be used for turning.



Talk Tube

Children have fun talking long distance with this great activity. Sound is conducted through underground tubing from one station to another. Talk tubes are used in pairs that can be attached to a playstructure or freestanding (as shown).



Log Roll

age 5^{to}12

The timberland comes to every playground! This balance building event is made rugged with rotomolded plastic in your choice of colors. It rotates on a solid bearing surface. This roll features raised knobs for traction and comes complete with grab handles.



Safety Signs

Every playground needs these essential child designation 3/4" polyethylene signs. Signs come mounted on a 2 3/8" freestanding post. 60 lbs. (27kg)

Item Numbers:
30022025 (2 to 5)
30022212 (2 to 12)
30022512 (5 to 12)
Price: \$212



Panel Ladder

For use between two decks with height differences of: 16", 24", 36", and 48"

Stairs/Ramps

All stairs are available as ground-to-deck or deck-to-deck units. Stairs are made from 12 gauge hot-rolled punched steel that is plastisol coated. Additional features include:

Treads & Stringers

- 12-gauge hot-rolled steel
- Plastisol coatings
- Perforated surface (1.25" o.c. between perforations)

Handrails, Gates & Barriers

- 1.25" o.d. round steel tube
- Powder coating

You can also make your play structure ADA accessible with an ADA Ramp or Transfer Station



Deck-To-Deck Stairs

Available in 21" and 33" deck increments. Also available; ADA 16", 24" and 36" deck increments



Ground-To-Deck Stairs

Available in 24", 36", 48", 60", 72" and 96" deck heights



Single Step



ADA Transfer Station

Deck Heights: 36" and 48"



ADA Ramp

48" grid only

4', 6' and 8' lengths available. ADA ramps can be deck-to-deck or ground-to-deck. These ramps are available with barriers or handrails.

Components: Bridges

All bridges can be used on 3.5" Adventure or 5" Expedition Systems and are in 8' length unless otherwise noted.

*Available in freestanding

**48" grid only



Pipe Bridge

Constructed with durable polyethylene gates and galvanized steel rails with a powder-coat finish. Use between two decks of equal height. Available for 24" to 48" deck heights.



Bubble Wall Bridge

Made from durable rotomolded plastic, our bubble wall bridge is a unique new traversing deck-to-deck climbing bridge. Available in any of our plastics colors. For use on any deck height between 12" to 48". Available in 15.5' length.



Chain Bridge**

age 5-12

Constructed of uni-welded chain with a plastisol coating for more traction. Galvanized steel guard rails with a powder-coat finish. Use between two decks of equal height. 12" to 30" deck heights.



Arch Bridge

Constructed of 12 gauge hot-rolled punched steel with a plastisol coating to increase traction. Side rails are constructed of durable polyethylene. Galvanized steel handrails with a powder-coat finish. Use between 2 decks of equal height. 12" to 72" deck heights.



90° Bridge

Constructed from 12 gauge hot-rolled punched steel with a plastisol coating to increase traction. Galvanized steel guard rails with a powder-coat finish. Use between 2 decks of equal height. 24" to 72" deck heights. 48" and 36" grids.



Inch Worm Bridge

age 5 to 12

Constructed of durable polyethylene with textured finish for traction. Galvanized steel frame with powder-coat finish. Torsion pivot base for side-to-side motion. 24" deck height only.



Challenge Bridge

age 5 to 12

Constructed of durable polyethylene with a textured finish for traction. Galvanized steel frame with powder-coat finish. Use between two decks of equal height. Available for 12" to 30" deck heights.



Lily Pad Bridge*

age 5 to 12

Constructed of durable polyethylene with a textured finish for traction. Galvanized steel frame with a powder-coat finish. Use between two decks of equal height. Available for 12" to 48" deck heights. Also available as ground to deck.



Suspension Bridge

One piece bridge for durability and ease of installation. Constructed from 12 gauge hot-rolled punched steel with a plastisol coating to increase traction. Galvanized steel guard rails with a powder-coat finish. Use between 2 equal deck heights. Available for 12" to 72" deck heights.

Horizontal Ladders promote physical fitness and develop upper body strength as well as hand-eye coordination. They connect between decks or from an end climber to a play system. They can also be ordered as freestanding events with two end climbers. Horizontal ladders are available for Adventure Series, Expedition Series or freestanding units, and are powder-coated to your choice of colors. See Page 135 for color selection. *End climber will be replaced with our new design as seen on Pages 98-99.



Wavy Deep Rung

Another great challenge. Large hand hold areas plus asymmetrical heights make this a #1 eye-hand coordination, upper-body developer.



270° Circle Ring

Metal hoops welded to a 270° circle make this a single deck launch play event. 48" Grid Only.

Track Ride

Children glide easily along this high quality Track Ride. Aluminum housing protects track mechanism giving you years of track riding fun. Heavy duty handle with one-of-a-kind self-braking system that keeps the handle from being thrown end-to-end.

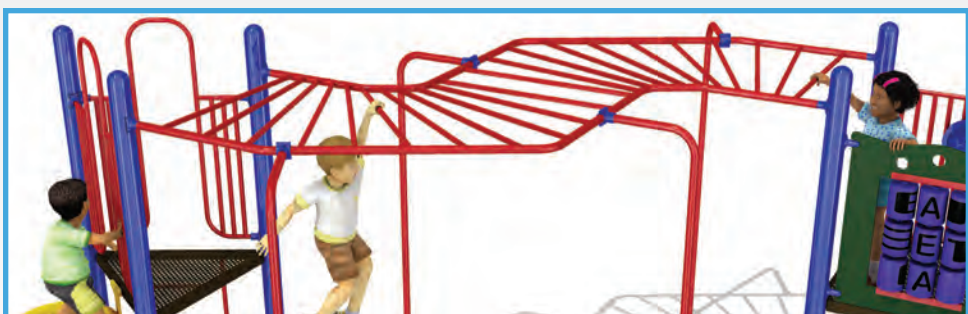

Offset Straight Rung

This is your fun connection for offset decks! Twists and turns make this ladder even more challenging.



Wavy Straight Rung

This horizontal ladder provides great play-on-power! The horizontal ladder no playground should be without.



Trapeze Ring

A Playland favorite! These sturdy polished aluminum trapeze rings attach to the frame with clevis fasteners for safety.



360° Orbital*

Fun comes full circle with this straight rung ladder. A great challenge for every child who wants to make it all the way around! 48" Grid Only.



Arched Straight Rung*

With its incline and decline, this horizontal ladder adds a new fun look to your playground.



Single Parallel Bar

The classic hand-over-hand bar. While appropriate for all ages, this is a great first step play event.



Double Parallel Bar

A great variation on the single parallel bar, this event is even more of a challenge and is just great fun.



Rapid Rocker

This event provides an advanced upper body workout. A challenging piece that promotes coordination, dexterity and fun for the older child. 5" only.



Tri-Rung

The Horizontal Ladder for any child ages 2 to 12. The big handles make gripping easy. And the angled ladder makes this an exciting deck-to-deck design element.



Loop Rung*

Each looped rung requires hand over hand reaching. Hands, wrists and forearms get a real workout, as well as the upper body muscles.

Climbers are available in a wide variety of shapes and sizes. From Playland favorites like the Tire Climber, to the offset ascension of the Bubble Wall Climber, these activities provide fun and challenging deck access. Plastic climbers are rotomolded with UV stabilized plastic. All metal climbers are available in any of our powder-coated finishes. See page 135 for color selection.

When specifying your climber designs, note the available deck heights. Just indicate the type of climber you want and a Playland representative will make sure it is installed at the correct deck height.

*48" grid only.



180° Loop-2-Loop
Deck Heights: 60" only



Bedrock*
Deck Heights: 36" - 48"



Bubble Wall
Deck Heights: 24" - 48"



Bubble

Deck Heights: 36" - 72"



Cargo Net*

Deck Heights: 24" - 60"



Chain Link*

Deck Heights: 48" & 60"



Clover

Deck Heights: 24" - 72"



Concentration

Deck Heights: 60" only



Deep Rung Arch

Deck Heights: 24" - 72"



Coil

Deck Heights: 24" - 72"



Education*

Deck Heights: 48" & 60"



Half Moon*

Deck Heights: 24" - 72"



Lily Pad

Deck Heights: 24" - 36"



Loop

Deck Heights: 36" - 48"

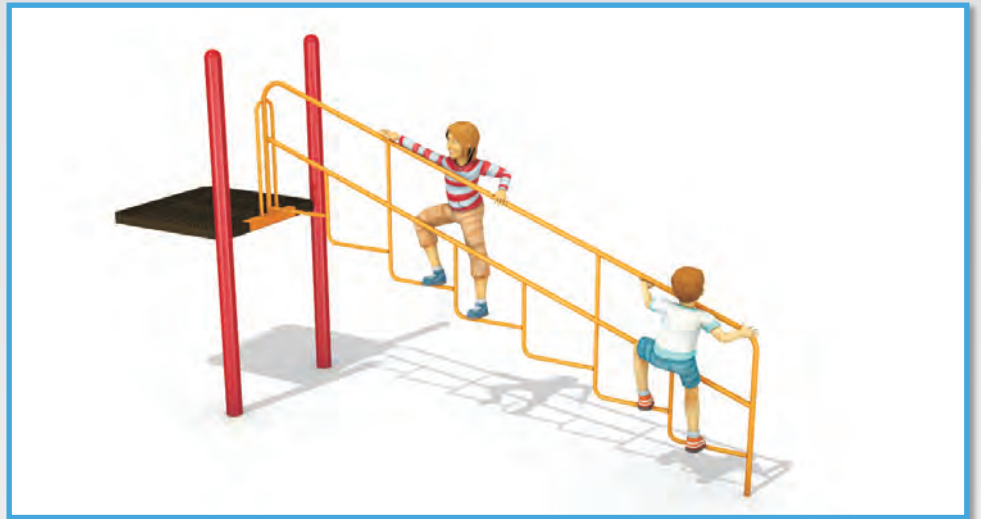

Mountain

Deck Heights: 60" only



Man Hole

Deck Heights: 24" - 72"



3x Pentagon

Deck Heights: 60" only



4x Pentagon

Deck Heights: 60" only



Rock Wall
Deck Heights: 60" only



Quick
Deck Heights: 24" - 72"



Ring
Deck Heights: 36" only



Snake
Deck Heights: 48" - 60"



Spiral
Deck Heights: 24" - 72"



Tire
Deck Heights: 60" only



Tree
Deck Heights: 24" - 72"



Zipper
Deck Heights: 24" - 72"

All of our molded slides are made with double wall construction for strength. They can be used on both Expedition and Adventure systems at the deck height shown and are available in all our standard plastic colors shown on page 135.

*48" grid only



60" Triple Rail*

Deck Heights: 60" only

Alpine Thunder

Deck Heights: 72" only



3' Right Turn

Deck Heights: 36" only



4' Right Turn

Deck Heights: 48" only



Triple Rail*

Deck Heights: 36", 48"



Wave

Deck Heights: 48", 60", 72"



Double Wall

Deck Heights: 24", 36", 48", 60"



Double Wide

Deck Heights: 36" only



360° Spiral

Deck Heights: 72" only



Chute*

Deck Heights: 48", 60", 72", 84", 96"

Please indicate straight or curve (left or right).
Curved Chute Slides not available in 48" deck heights.



Triple Chute (Straight or Split)

Deck Heights: 60", 72", 84", 96"

Components: Tube Slides

Sliding fun begins at the top of a tube slide! Our rotomolded high-strength plastic slides are available in 24" (36" grid) or 30" (48" grid) diameters in any of our plastic colors. See page 135 for color selection. Slides pictured below are 30" diameter. Four different configurations (straight, zigzag, 360° and 90°).



Straight Tube Slide

Deck Heights: 24", 36", 48", 60", 72", 84", 96"

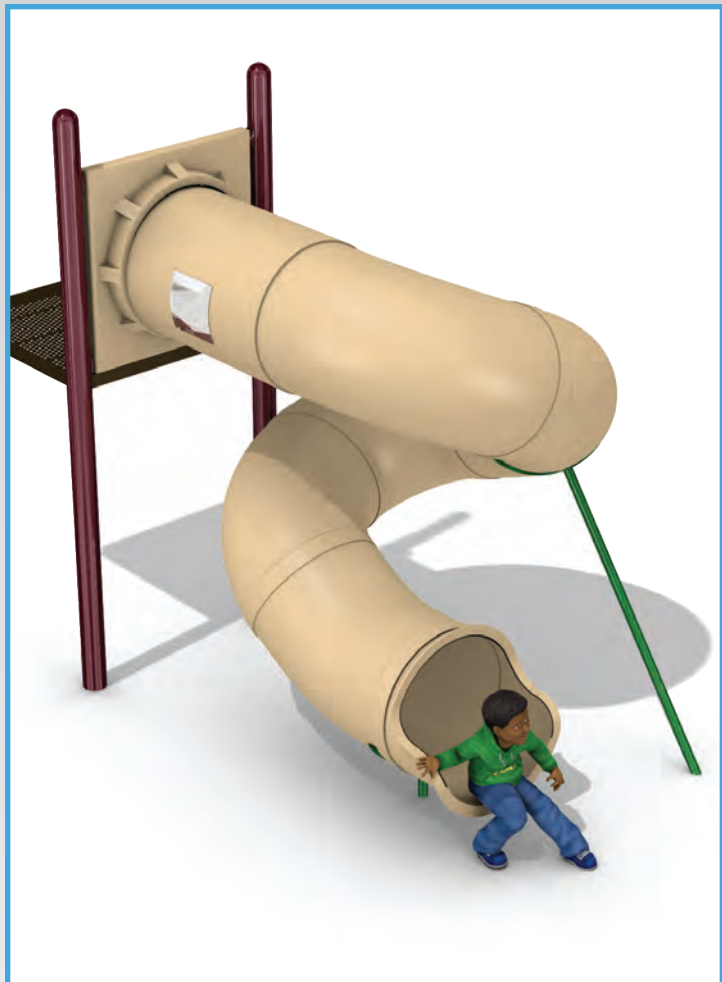

360° Tube Slide

Deck Heights: 72", 84", 96"



Please note when planning to indicate zig-zag left or zig-zag right.

Zig-Zag Tube Slide

Deck Heights: 36", 48", 60", 72", 84", 96"



Please note when planning to indicate curve left or curve right.

90° Tube Slide

Deck Heights: 36", 48", 60", 72", 84", 96"

Crawl tunnels connect decks of the same or offset heights. They can also be designed to be freestanding. Crawl tunnels are made of high quality rotomolded plastic and are available for Adventure Series or Expedition Series in any of our plastics colors (see page 135 for color selection). All crawl tunnels come with spy holes for easy supervision of children and are available in 24" (36" grid) or 30" (48" grid) diameters. Other features include:

- 1st quality LDPE
- 3/8" wall thickness
- UV stabilized
- Anti-static inhibitors



Inclined Crawl Tunnel

Connects two decks at 6", 12" or 24" height increments

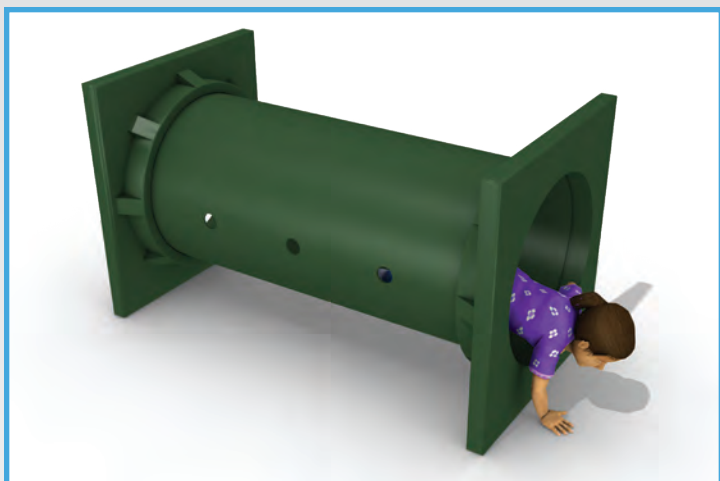

Straight Crawl Tunnel

Connects two decks of same height.
Lengths as shown in your Playland diagrams.

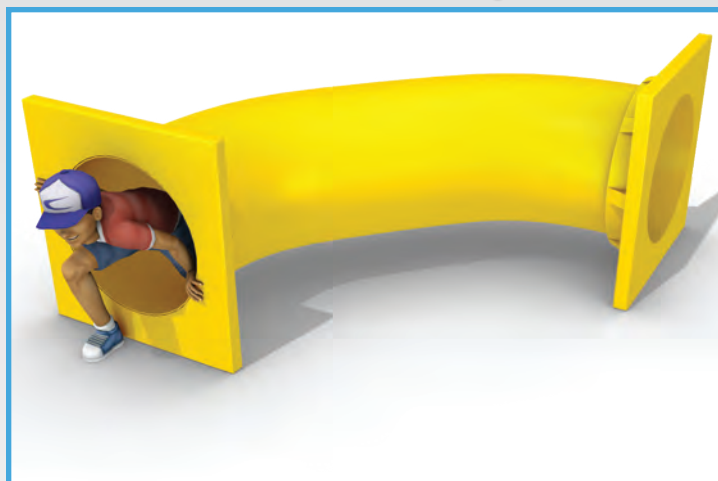

Curved Crawl Tunnel

Connects two decks of same height.
Degrees of curve as shown in your Playland diagrams.

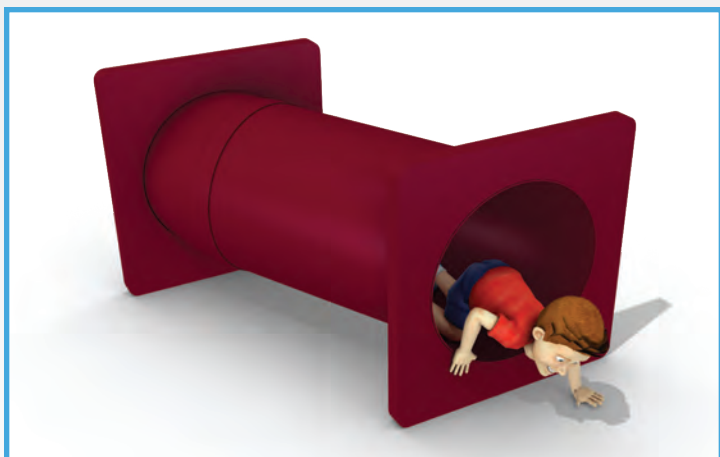

Zig-Zag Crawl Tunnel

Offsets two decks of same height by 24".

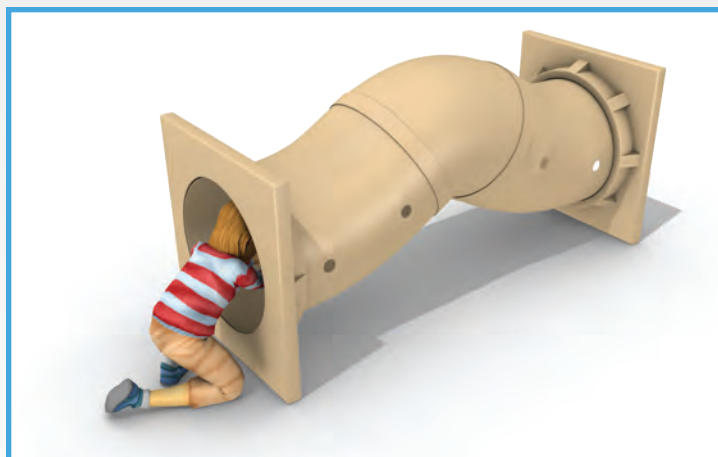

Wavy Crawl Tunnel

Connects two decks of same height.

Components: Activity Panels

Activity panels are available for 36" and 48" grids. They can be installed at deck level, below deck heights greater than 48" or freestanding.

All panels are constructed of 3/4" heavy duty high density polyethylene (HDPE) sheet plastic. They resist fading and warping for a lifetime of activity.

See page 135 for color selection.

*Ground level only

**48" grid only



Custom



Bubble

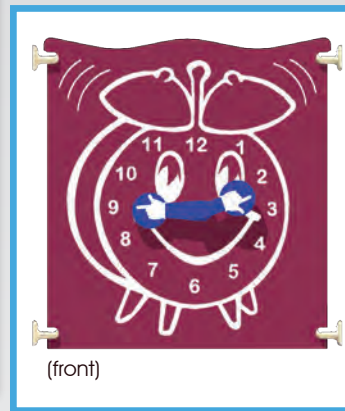

(front)



(back)

Clock/Sign Language

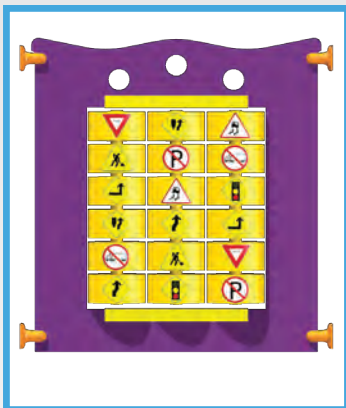

Concentration

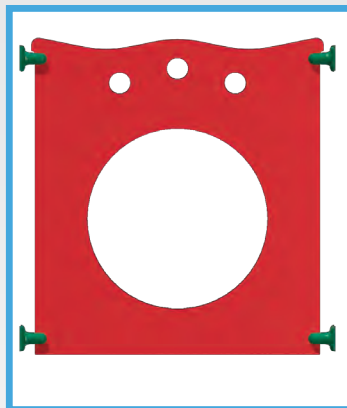

Crawl Through*

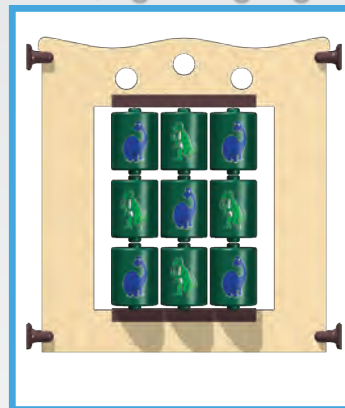

Dinosaur

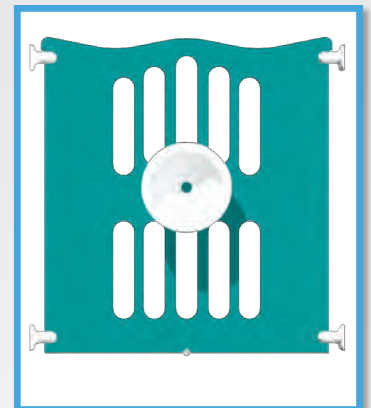

Driving

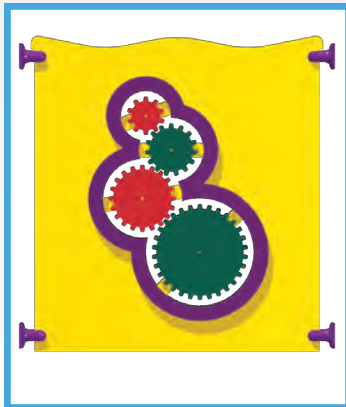

Gear



(front)



(back)

Solar System



Faith**

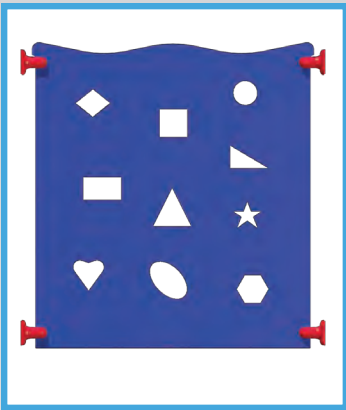

Geo

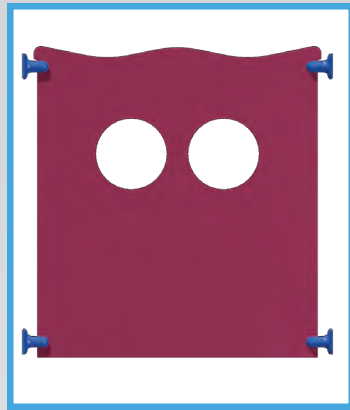

Puppet*



(front)



(back)

State** Avail. in all 50 states

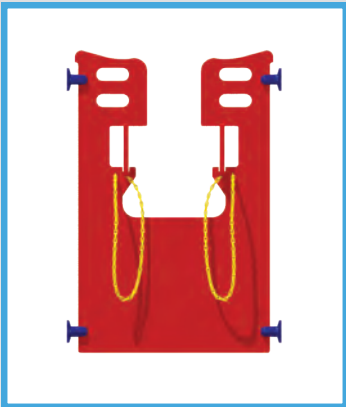

Gas Station*



(front)



(back)

Spanish to English**

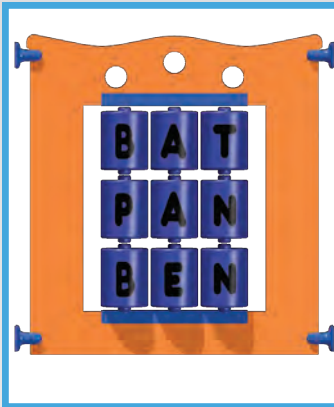

Spelling

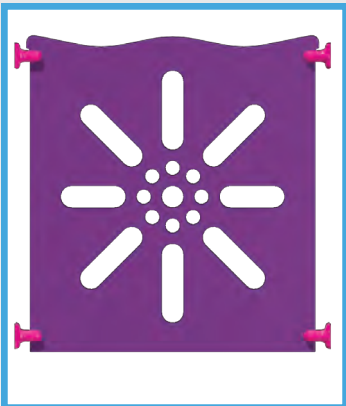

Starburst

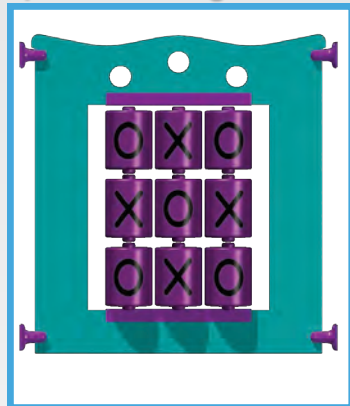

Tic-Tac-Toe

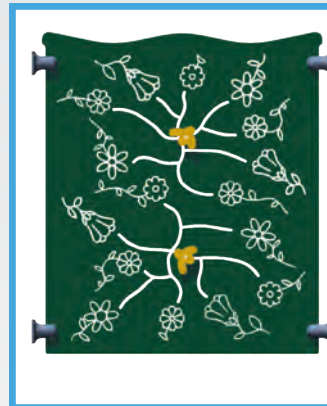

Honey Bee



Slotted

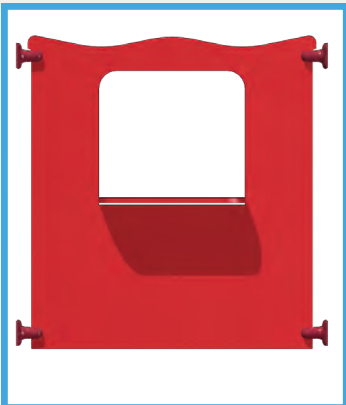

Store Front*



(front)



(back)

USA Map**

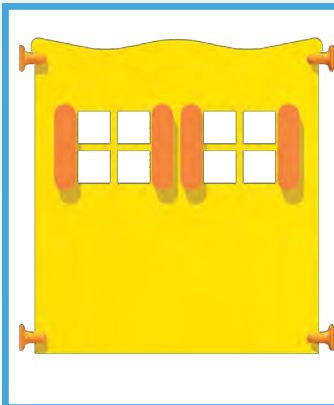

Window

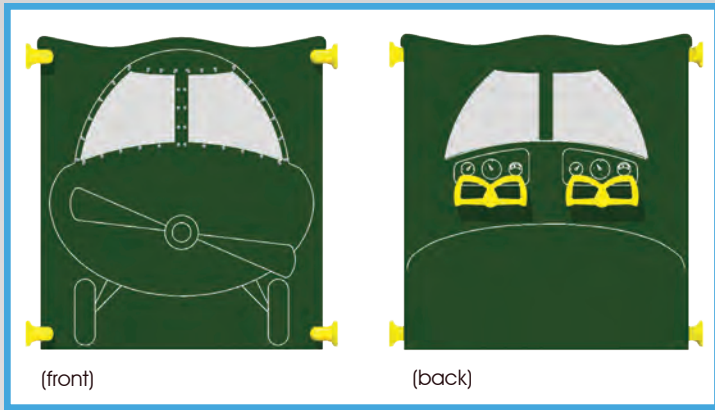

Airplane



Window w/Seat*



Alpha

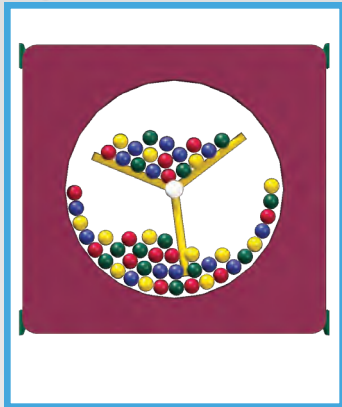

Ball Turn**

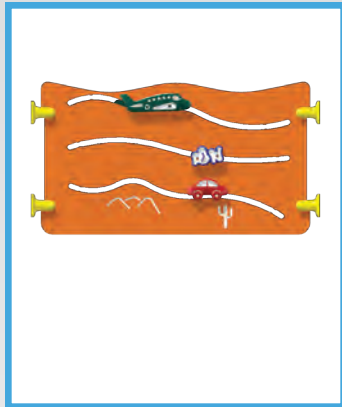

Half Push*



Half Yoke Motion*

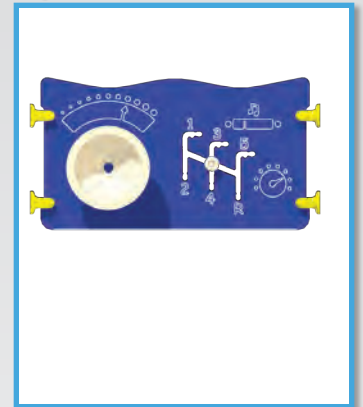

Half Drive Shift*

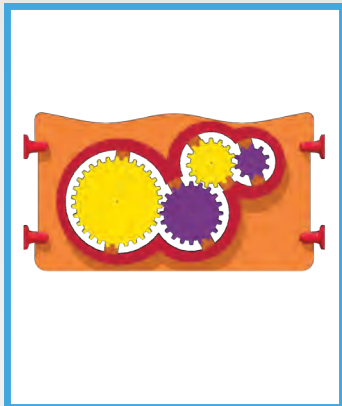

Half Gear* **

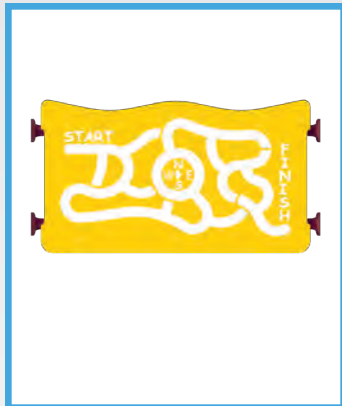

Half Maze*

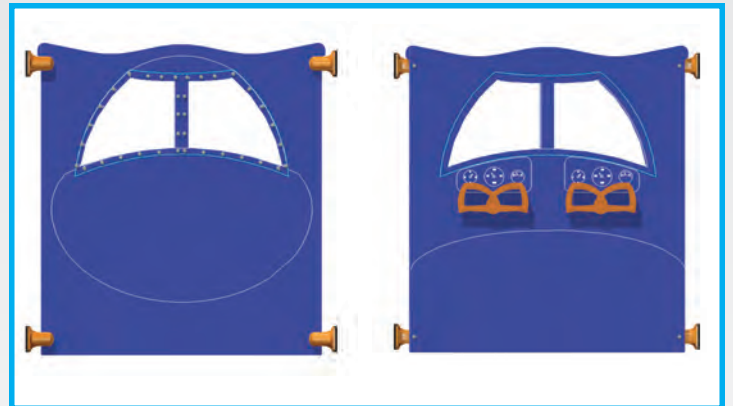

Space Ship

NEW!

Jungle Themes
 These themed panels encourage imaginative play with playful renderings of the jungle's inhabitants.



Monkey/Tree



Toucan

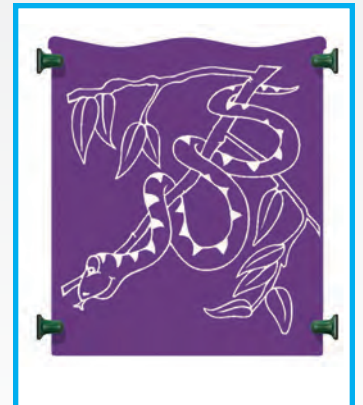

Snake

Traffic Signs

No trike path is complete without these new traffic direction accessories. Each sign is made of the same heavy duty HDPE plastic used in our 36" and 48" activity panels. They resist fading and warping for a lifetime of imagination. Each sign includes a post and mounting hardware.



Stop



Yield

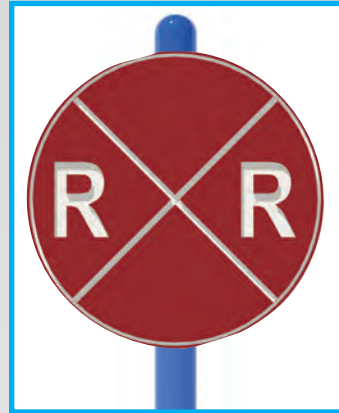

Railroad Crossing



No Parking

Barriers

These devices are essential for directing traffic throughout the play structure. Barriers keep decks safe, but they can also be an important play element. As pictured here, barriers can be plain pipe walls or play activities, such as a pipe wall with wheel.

See page 135 for color selection.



Pipe Wall

Pipe Wall w/Wheel

Roofs are an essential part of your playground environment, providing shade for hours of safe fun. They are also an important feature in the design of your playground.

Roofs are available to fit both Expedition and Adventure series. Choose whatever color you like from our color selection on page 135.

We also offer an archway to enhance the look of your playground. Plan archways into any deck that you wish to accentuate as an entryway, or use them to balance your playground visually.



Modular Shade Roof

Reduce UV exposure and provide a color play environment with a modular shade roof. Additional shade products shown on page 128. Fits Square Decks Only.



Arch Metal Roof

Add a classic architectural touch to your playground with our Arch Metal Roof.

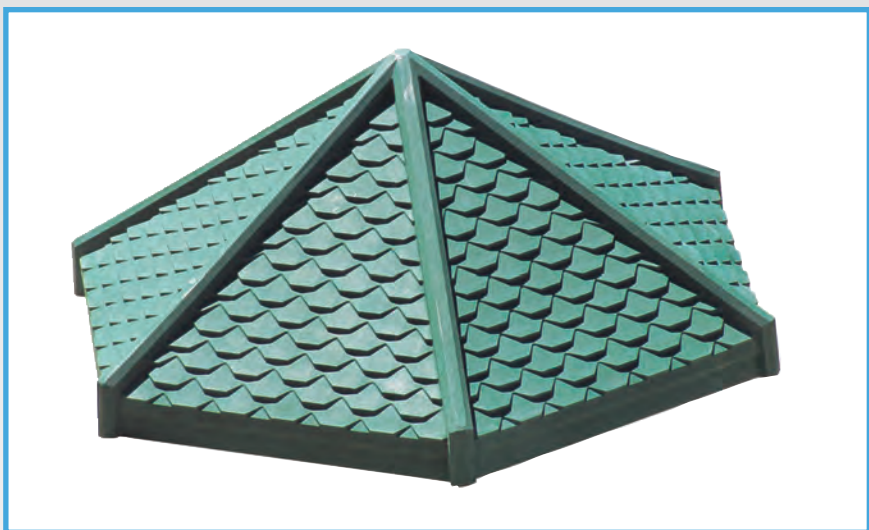

Hex Roof



Archway

Give a playground a grand entry with an archway. Looks great when used with Arch Metal Roofs.

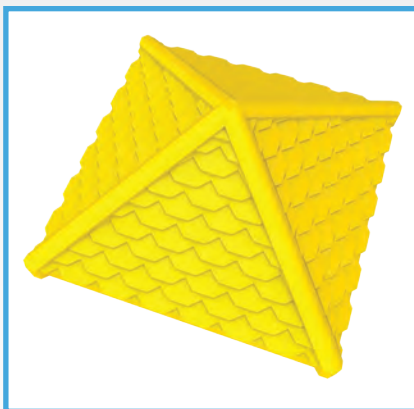

Square Shingle Roof

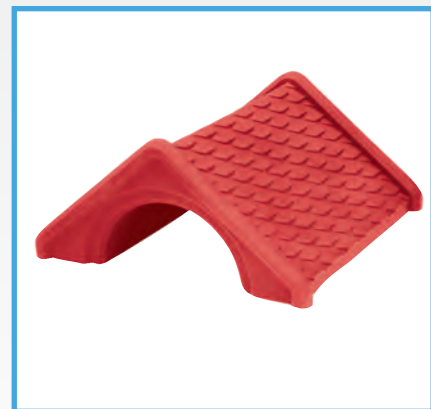

Gabled Shingle Roof

Touch the sky with a wide range of swings

Get all the swings you need from Playland! We have full bucket and half bucket seats for preschoolers and belt seats for children 5-12 years old. These are tough, all-season swings made for lots of heavy use. They come in a variety of colors to match your playground color scheme. Please note that you can order standard galvanized chain or easy-on-the-hands yellow plastisol coated chain. Coated chain adds color and comfort to every swing event! Clevis fasteners are standard on every swing. This child-friendly hardware is the best way to meet safety standards.

Playland also offers the most popular options for swing structures: bi-pod frame, tri-pod frame, single post frame and arched frame. The entire single post and arched frames are coated to any of our post color selections (see page 133 for the Playland color palette). The bi-pod and tri-pod frames come with powder-coated junction sections and galvanized frames.

Easy steps to designing your swing set

Select swing set frame type

- Bi-pod
- Tri-pod
- Single 5" Post
- Arched 3.5" or 5"

Choose the type(s) of seats

- Belt
- Bucket
- Half-Bucket

Pick type of chain

- Standard Galvanized
- Yellow Vinyl Coated

Select swing set frame

For example: 1,2,3 or 4 bays
(Each bay holds 2 swings)

Select colors

Seat color choices on pages 89-90
See frame color choices on page 135



- 5" Arch Frame [Page 86](#)
- 3.5" Arch Frame [Page 86](#)
- Bi-Pod Frame [Page 87](#)
- Tri-Pod Frame [Page 87](#)
- Single Post Frame [Page 88](#)
- Arched Frame Tire Swing [Page 88](#)
- Seats & Chain Sets [Page 89](#)
- Tires & Chain Sets [Page 90](#)
- Replacement Parts [Page 91](#)



5" Arch Swing Frame

This swing is the ultimate in strength and structural integrity. This is the heavy use champion! The 5" Arch Swing frames are constructed of the same high quality 5" steel tubing used in the Expedition Series. The top bar is also 5" tubing. The entire frame is powder-coated to match your playground. See page 135 for color selection.

Note: Swing frames come with hangers but not seats or chain. Order swing seat and chain sets from pages 89-90.

| Description | Item Number | Use Zone | Weight | Price |
|---------------------------|-------------|---------------------|--------------------|---------|
| 5" Arched, 8' - 1 bay | 90015501 | 24'x32' (7.3x9.8m) | 390 lbs. (177 kg) | \$1,732 |
| 5" Arched, 8' - 2 bay | 90015502 | 36'x32' (11.0x9.8m) | 620 lbs. (281 kg) | \$2,837 |
| 5" Arched, 8' - 3 bay | 90015503 | 47'x32' (14.6x9.8m) | 850 lbs. (386 kg) | \$3,943 |
| 5" Arched, 8' - 4 bay | 90015504 | 58'x32' (18.3x9.8m) | 1080 lbs. (490 kg) | \$5,047 |
| 5" Arched, 8' - Add-A-Bay | 90915500 | 24'x32' (7.3x9.8m) | 230 lbs. (104 kg) | \$1,106 |



3.5" Arch Swing Frame

This simple architecturally styled arch frame is a fun swing alternative. The 3.5" Arch Swing frames and 2 3/8" top bars are constructed of the same high quality steel tubing used in our play structures. The entire frame is powder-coated to match your playground. See page 135 for color selection.

Note: Swing frames come with hangers but not seats or chain. Order swing seat and chain sets from pages 89-90.

| Description | Item Number | Use Zone | Weight | Price |
|-----------------------------|-------------|---------------------|---------------------|---------|
| 3.5" Arched, 8' - 1 bay | 90015201 | 24'x32' (7.3x9.8m) | 225 lbs. (102.1 kg) | \$1,180 |
| 3.5" Arched, 8' - 2 bay | 90015202 | 36'x32' (11.0x9.8m) | 325 lbs. (161.0 kg) | \$1,821 |
| 3.5" Arched, 8' - 3 bay | 90015203 | 48'x32' (14.6x9.8m) | 485 lbs. (220.0 kg) | \$2,462 |
| 3.5" Arched, 8' - 4 bay | 90015204 | 58'x32' (18.3x9.8m) | 615 lbs. (279.1 kg) | \$3,101 |
| 3.5" Arched, 8' - Add-A-Bay | 90915200 | 24'x32' (7.3x9.8m) | 150 lbs. (68 kg) | \$642 |



Bi-Pod Swing Frame

This is your basic swing for fun. The Bi-pod frames use 2 3/8" galvanized pipe for the legs and top bar and powder-coated aluminum castings for their junctions.

See page 135 for color selection.

Note: Swing frames come with hangers but not seats or chains. Order swing seat and chain sets from pages 89-90.

***Powder coated frames available for additional charge.**

****For swing pad with beveled edge see page 91**

| Description | Item Number | Use Zone | Weight | Price |
|--------------------------------|-----------------|--------------------|-------------------|---------|
| Bi-pod, 8' - 1 bay | 90015401 | 25'x32' (9x10m) | 180lbs. (82kg) | \$556 |
| Bi-pod, 8' - 2 bay | 90015402 | 36'x32' (12.5x10m) | 280lbs. (127kg) | \$949 |
| Bi-pod, 8' - 3 bay | 90015403 | 47'x32' (16x10m) | 380lbs. (172.5kg) | \$1,341 |
| Bi-pod, 8' - 4 bay | 90015404 | 58'x32' (20x10m) | 480lbs. (218kg) | \$1,732 |
| Bi-pod, 8' - Add-A-Bay | 90915400 | 25'x32' (9x10m) | 100lbs. (45kg) | 394 |
| *Powder-Coated Frame (per bay) | Swing PC Charge | | | \$263 |



Tri-Pod Swing Frame

The advantage of the Tri-pod frame is the ability to go to a 10' height for added swing play. The Tri-pod frames use 2 3/8" galvanized pipe for the legs and top bar and powder-coated aluminum castings for their junctions. See page 135 for color selection.

Note: Swing frames come with hangers but not seats or chains. Order swing seat and chain sets from pages 89-90.

***Powder coated frames available for additional charge.**

| Description | Item Number | Use Zone | Weight | Price |
|--------------------------------|-----------------|--------------------|-------------------|---------|
| Tri-pod, 8' - 1 bay | 90015301 | 33'x32' (10.5x10m) | 230lbs. (104.5kg) | \$666 |
| Tri-pod, 8' - 2 bay | 90015302 | 45'x32' (14x10m) | 330lbs. (150kg) | \$1,089 |
| Tri-pod, 8' - 3 bay | 90015303 | 56'x32' (17x10m) | 430lbs. (195kg) | \$1,527 |
| Tri-pod, 8' - 4 bay | 90015304 | 67'x32' (20.5x10m) | 530lbs. (240.5kg) | \$1,963 |
| Tri-pod, 8' - Add-A-Bay | 90015300 | 33'x32' (10.5x10m) | 100lbs. (45.5kg) | \$438 |
| Tri-pod, 10' - 1 bay | 90015311 | 36'x40' (11.5x12m) | 260lbs. (118kg) | \$746 |
| Tri-pod, 10' - 2 bay | 90015312 | 47'x40' (15x12m) | 360lbs. (163.5kg) | \$1,162 |
| Tri-pod, 10' - 3 bay | 90015313 | 58'x40' (18.5x12m) | 460lbs. (209kg) | \$1,629 |
| Tri-pod, 10' - 4 bay | 90015314 | 69'x40' (21.5x12m) | 560lbs. (254kg) | \$2,098 |
| Tri-pod, 10' - Add-A-Bay | 90015391 | 36'x40' (11.5x12m) | 100lbs. (45.5kg) | \$469 |
| *Powder-Coated Frame (per bay) | Swing PC Charge | | | \$263 |



5" Single Post Swing Frame

This is the space saving frame for smaller areas. The entire frame for the Single 5" Post Swing is constructed of 5" tubing and powder-coated to match your playground.

See page 135 for color selection.

Note: Swing frames come with hangers but not seats or chains. Order swing seat and chain sets from pages 89-90.

| Description | Item Number | Use Zone | Weight | Price |
|-------------------------------------|-------------|--------------------|------------------|---------|
| 5" Single Post, 8' - 1 bay | 90015101 | 24'x32' (7.5x10m) | 271 lbs. (123kg) | \$880 |
| 5" Single Post, 8' - 2 bay | 90015102 | 36'x32' (11x10m) | 362 lbs. (164kg) | \$1,574 |
| 5" Single Post, 8' - 3 bay | 90015103 | 47'x32' (15x10m) | 453 lbs. (206kg) | \$2,331 |
| 5" Single Post, 8' - 4 bay | 90015104 | 59'x32' (18.5x10m) | 544 lbs. (247kg) | \$3,088 |
| 5" Single Post, 8' - Add-A-Bay | 90915100 | 24'x32' (7.5x10m) | 911 lbs. (413kg) | \$758 |
| 5" Single Post, 8' w/ Shade - 2 bay | TFR08980 | 36'x32' (11x10m) | 299 lbs. (136kg) | \$1,138 |



5" Arched Tire Swing Frame

Playland also makes the very popular Tire Swing. The entire frame for the swing is constructed of 5" steel tubing and powder-coated to your choice of color.

See page 135 for color selection.

Tire swings are available in 1, 2, 3 or 4 bays.

Note: Swing frames come with hangers but not tires or chains. Order tire and chain sets from page 90.

| Description | Item Number | Use Zone | Weight | Price |
|--------------------------------|-------------|-------------------|--------------------|---------|
| 5" Arched Tire, 8' - 1 bay | 90015991 | 22'x28' (7x9m) | 550lbs. (249.5kg) | \$1,827 |
| 5" Arched Tire, 8' - 2 bay | 90015992 | 22'x44' (7x14m) | 860lbs. (390kg) | \$3,021 |
| 5" Arched Tire, 8' - 3 bay | 90015993 | 22'x59' (7x21m) | 1170lbs. (531kg) | \$4,217 |
| 5" Arched Tire, 8' - 4 bay | 90015994 | 22'x74' (7x22.5m) | 1480lbs. (249.5kg) | \$5,411 |
| 5" Arched Tire, 8' - Add-A-Bay | 90945900 | 22'x28' (7x9m) | 310 lbs. (141kg) | \$1,197 |

age 2^{to}3 Available Colors for Full Bucket Seats

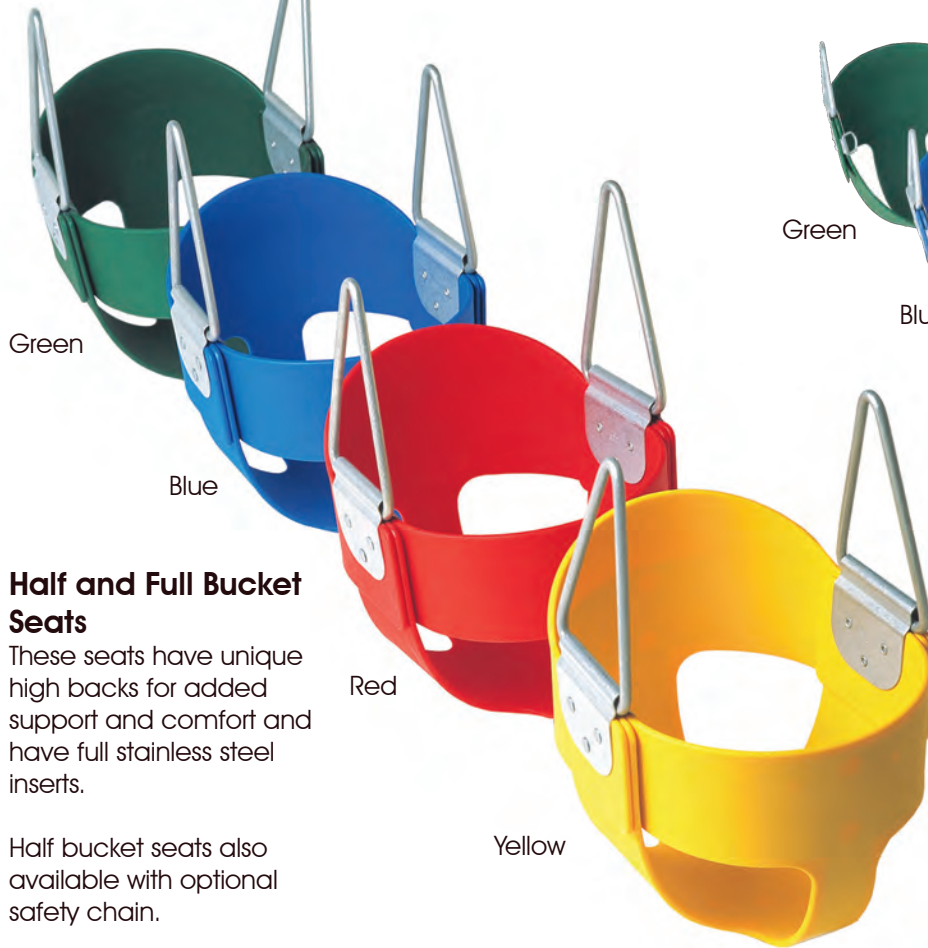

age 2^{to}5 Available Colors for Half Bucket Seats



Half and Full Bucket Seats

These seats have unique high backs for added support and comfort and have full stainless steel inserts.

Half bucket seats also available with optional safety chain.

Each item number includes two seats and all necessary chain and hardware for each swing bay. Order one item number per bay ordered.

| Description | Item # | Length | Weight | Price |
|---|----------|-----------|-----------------|------------|
| Half Bucket Seats S-24, 8' Galvanized Chain Set | 90015120 | 58" Chain | 28 lbs. (13kg) | \$154 |
| Full Bucket Seats S-25, 8' Galvanized Chain Set | 90015130 | 54" Chain | 38 lbs. (17kg) | \$211 |
| Half Bucket Seats S-24, 8' Plastisol Chain Set | 90015220 | 58" Chain | 30 lbs. (14kg) | \$241 |
| Full Bucket Seats S-25, 8' Plastisol Chain Set | 90015230 | 54" Chain | 40 lbs. (18kg) | \$291 |
| Bucket Seat Chain S-11 | 0060000 | | .3 lbs. (0.2kg) | \$6 (each) |

Available half bucket seat chain. Sold separately.



ADA Swing Seat

Available in Red, Yellow, Blue, Green, Tan, and Black. Seat, chain, and harness sold separately. Please call for pricing.

age 5to12 Available Colors for Belt Seats



Belt Seat

Molded seat with galvanized triangle hardware. This tough swing seat has high carbon steel spring inserts to resist vandalism. 6"x24"

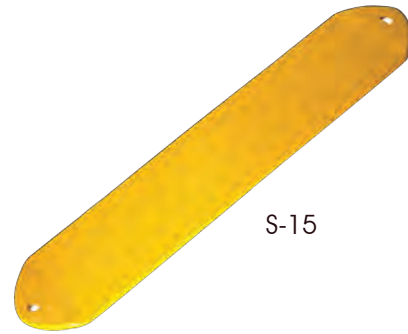

Best Belt Seat

Our finest belt seat. Molded-in stainless steel insert with internal reinforcing grommets. Available in colors at left except red. 5-1/2" x 26-1/4"

Belt Seats & Chain Sets

| Description (per bay) | Item # | Length | Weight | Price |
|---------------------------------------|----------|-----------|----------------|-------|
| Belt Seats S-02, 8' Galvanized Chain | 90015108 | 68" Chain | 27 lbs. (12kg) | \$114 |
| Belt Seats S-02, 10' Galvanized Chain | 90015110 | 91" Chain | 29 lbs. (13kg) | \$124 |
| Belt Seats S-02, 8' Plastisol Chain | 90015208 | 68" Chain | 29 lbs. (13kg) | \$207 |
| Belt Seats S-02, 10" Plastisol Chain | 90015210 | 91" Chain | 31 lbs. (14kg) | \$249 |

Each set includes two seats and all necessary chain and hardware for each swing bay. Order one item number per bay ordered.

Replacement Seats

| Description (per seat) | Item # | Weight | Price |
|------------------------------------|----------|-----------------|-------|
| Belt Replacement Seat, S-02 | 90015810 | 3.1 lbs. (2kg) | \$31 |
| Best Belt Replacement Seat, S-15 | 90015815 | 3.1 lbs. (2 kg) | \$33 |
| Half Bucket Replacement Seat, S-24 | 90015820 | 3.6 lbs. (2kg) | \$46 |
| Full Bucket Replacement Seat, S-25 | 90015830 | 8.5 lbs. (4kg) | \$86 |

Replacement Chains

| Description | Item # | Weight | Price |
|--|----------|------------------|-------|
| 4/0 Heavy Duty Galvanized Chain (per ft) | 90015600 | 0.4 lbs. (0.2kg) | \$3 |
| 68" Plastisol Coated Chain (per pair) | 90015668 | 2.4 lbs. (1kg) | \$53 |
| 91" Plastisol Coated Chain (per pair) | 90015685 | 3.4 lbs. (1.5kg) | \$69 |
| 54" Plastisol Coated Chain (per pair) | 90015748 | 1.6 lbs. (1kg) | \$39 |
| 58" Plastisol Coated Chain (per pair) | 90015752 | 2 lbs. (1kg) | \$42 |



Standard Galvanized 4/0 Chain



Yellow Plastisol Coated 4/0 Chain

Tire Swing & Chain Sets

Each set includes one tire and all necessary chain and hardware for each swing bay. Order one item number per bay ordered. Rotomolded tires available in any of our plastics colors on page 135.

| Description | Item # | Weight | Price |
|--|----------|-------------|-------|
| Black Tire w/Galvanized Chain Set | 90015804 | 3lbs. (2kg) | \$199 |
| Black Tire w/Plastisol Coated Chain Set | 90015803 | 3lbs. (2kg) | \$295 |
| Rotomolded Tire w/Galvanized Chain Set | 90015802 | 4lbs. (2kg) | \$180 |
| Rotomolded Tire w/Plastisol Coated Chain Set | 90015801 | 9lbs. (4kg) | \$268 |



Rotomolded Tire



Ductile Iron Swing Hangers

These high-quality ductile iron swing hangers have a steel pivot bolt that suspends a tough bronze bushing.



Stamped Steel Swing Hangers

These high-quality stamped steel swing hangers have a steel pivot bolt that suspends a tough bronze bushing.

Replacement Pendulum

Includes bronze bushing and fits both ductile iron and stamped steel hangers.



RP-02



RP-01

Clevis Key

90015516



Clevis

90015515

| Description | Item # | Weight | Price |
|-----------------------------------|------------|-------------------|-------|
| 2-3/8" Ductile Iron Hanger SH-23 | 9001550991 | 2.1 lbs. (1.0 kg) | \$19 |
| 3-1/2" Ductile Iron Hanger SH-24 | 9001551091 | 4.1 lbs. (2.0 kg) | \$23 |
| 2-3/8" Stamped Steel Hanger SH-35 | 90015535 | 2.0 lbs. (0.9 kg) | \$16 |
| 3-1/2" Stamped Steel Hanger SH-36 | 90015536 | 3.0 lbs. (1.3 kg) | \$23 |
| 4-1/2" Stamped Steel Hanger SH-37 | 90015537 | 3.5 lbs. (1.5 kg) | \$23 |
| 5" Stamped Steel Hanger SH-38 | 90015538 | 4.0 lbs. (2.0 kg) | \$23 |
| Replacement Pendulum RP-01 | 90015505 | 0.6 lbs. (0.3 kg) | \$9 |
| Replacement Pendulum RP-02 | 90015506 | 0.6 lbs. (0.3 kg) | \$9 |
| Clevis | 90015515 | 0.2 lbs. (0.1 kg) | \$6 |
| Clevis Key | 90015516 | 0.1 lbs. (0.1 kg) | \$4 |

Beveled Swing Pads

Add protection below each swing in areas where infill type surfacing is used to minimize displacement of surfacing and add additional impact-attenuation.

| Description | Item # | Size | Weight | Price |
|--------------------------|---------|--------------|-----------------|-------|
| Swing Pad w/Beveled Edge | 9000404 | 40"x40"x1.5" | 64 lbs. (29 kg) | \$90 |



Complete your playground with Independent Events.

Independent play structures are a great way to provide an alternate play environment for a child. While the main playground structure is great for group play, these bright imaginative play components attract one or perhaps a few children at a time creating a whole new play experience. They can provide a needed rest from the crowds on the playground.

Independent ground level events are also a requirement for the ADA guidelines. It is important to give every child a fun, challenging environment.

You will find in the following pages a complete range of age appropriate equipment. As always, be sure to note safe use zones.



Choose From Over 60 Independent Play and Freestanding Events!

- Climbers Page 93
- Slides Page 97
- Horizontal Ladders Page 98
- Riders Page 100
- Activities Page 101
- Balance Page 102
- Fitness Page 104
- Sports & Games Page 105

Dymaxion Web Climbers

The Dymaxion Web is all about fun. Constructed from nylon sheathed steel cable, this flexible climber is built to last.

Cable is available in red only.

Posts are available in any of our powder coat colors, as shown on page 135

19' Dymaxion Web
\$21,135

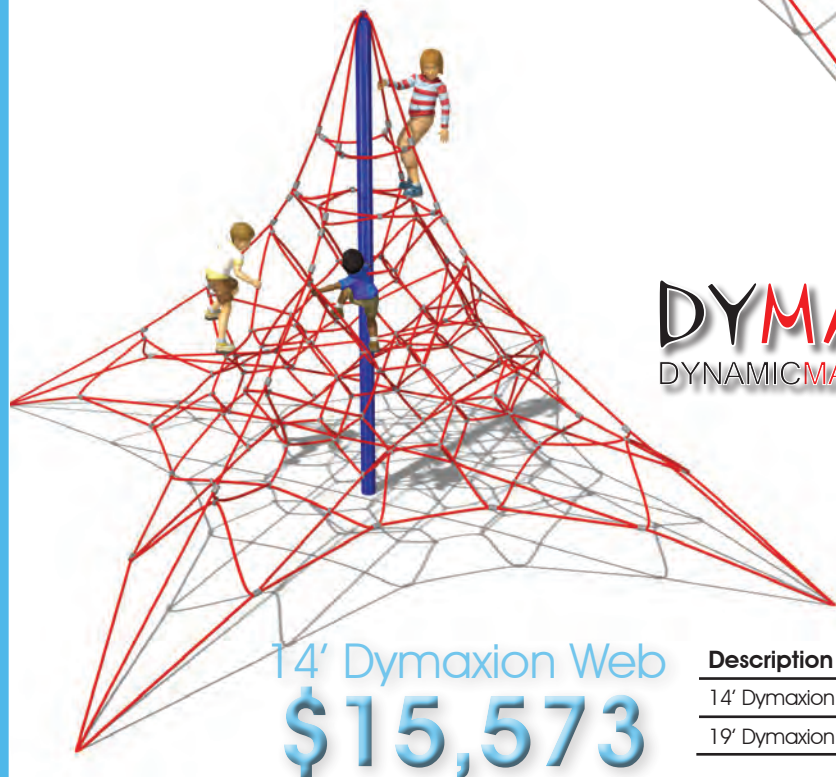
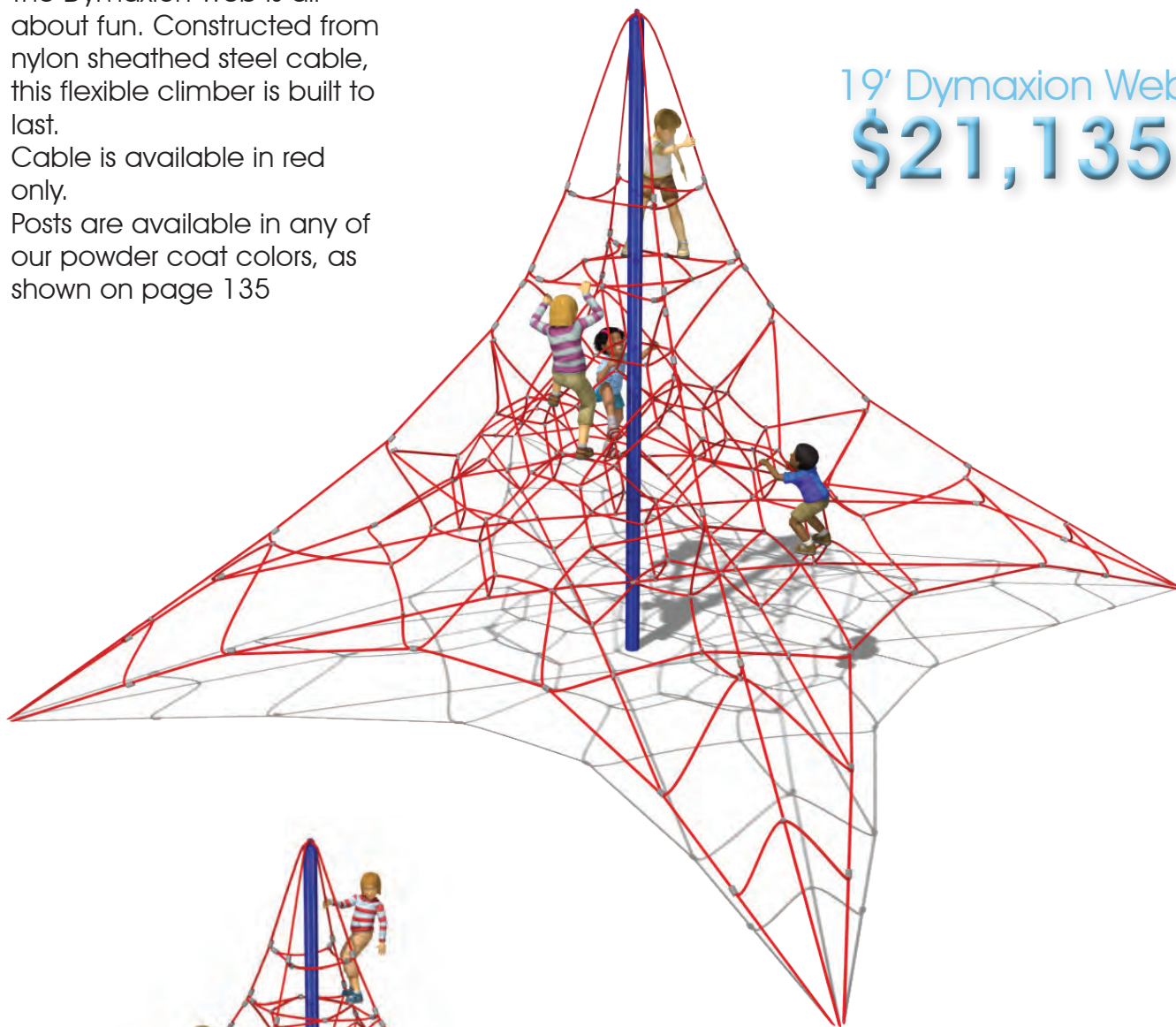

DYMAXION WEB
 DYNAMIC MAXIMUM ACTION

age 5-12

14' Dymaxion Web
\$15,573

| Description | Item # | Use Zone | Weight | Price |
|--------------|----------|-----------|-----------------|----------|
| 14' Dymaxion | MSC09786 | 47' x 47' | 557lbs. (253kg) | \$15,573 |
| 19' Dymaxion | MSC09787 | 55' x 55' | 688lbs. (312kg) | \$21,135 |

Chain Link Walls

Roto-molded links make this freestanding unit a unique traversing climber. Rotomolded links and powder-coated posts in your choice of colors. See page 135 for color selection.

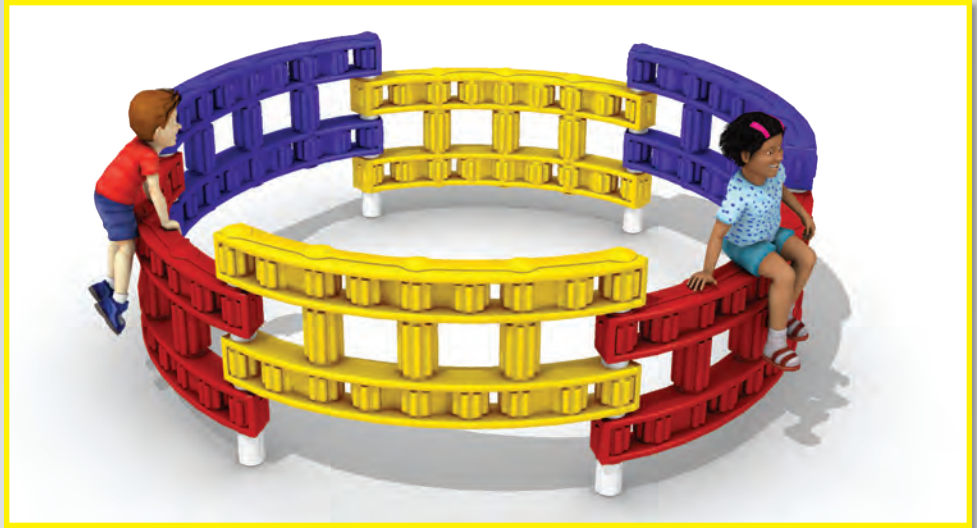

Chain Link Circle

| Item # | Use Zone | Weight | Price |
|----------|-----------|------------------|---------|
| TFR08828 | 24' x 24' | 552 lbs. (251kg) | \$3,174 |



All-Out Chain Link Wall

| Item # | Use Zone | Weight | Price |
|----------|-----------|------------------|---------|
| TFR08826 | 24' x 24' | 552 lbs. (251kg) | \$3,174 |



3-Section Chain Link Wall

| Item # | Use Zone | Weight | Price |
|----------|-----------|-----------------|---------|
| TFR08456 | 14' x 30' | 292 lbs. (89kg) | \$1,768 |

Bubble Walls

Rotomolded panels combine to make a fun traversing climber. Rotomolded panels and powder-coated posts in your choice of colors. See page 135 for color selection.



4-Section Bubble Wall

| Item # | Use Zone | Weight | Price |
|----------|----------|------------------|---------|
| TFR09121 | 14x30' | 564 lbs. (256kg) | \$2,215 |



8-Section Bubble Wall Circle

| Item # | Use Zone | Weight | Price |
|----------|-----------|--------------------|---------|
| TFR09122 | 26' x 26' | 1,128 lbs. (512kg) | \$4,439 |

Independent: Climbers

Panel Climbers

Unique hand and foot holds give just the right amount of challenge for a climb to the top! 3/4" high-strength polyethylene panels in your choice of panel colors on 3.5" (pictured) or 5" posts. See page 135 for color selection.

age 5-12



Triple Panel Climber
 3" Item #90007001 \$1,773
 5" Item #90007501 \$2,972



Double Panel Climber
 3" Item #90007021 \$1,233
 5" Item #90007521 \$2,073



Single Panel Climber
 3" Item #90007005 \$691
 5" Item #90007505 \$1,190



Space Pod

Great play value! It can accommodate many children in a small area. Easy bolt-together assembly. Available in up to 2 powder-coat colors as listed. 1 color for all hexagon panels. 1 color for all pentagon panels.

| Item # | Use Zone | Weight | Price |
|----------|-----------|------------------|---------|
| 90007110 | 22' x 22' | 315 lbs. (143kg) | \$1,683 |

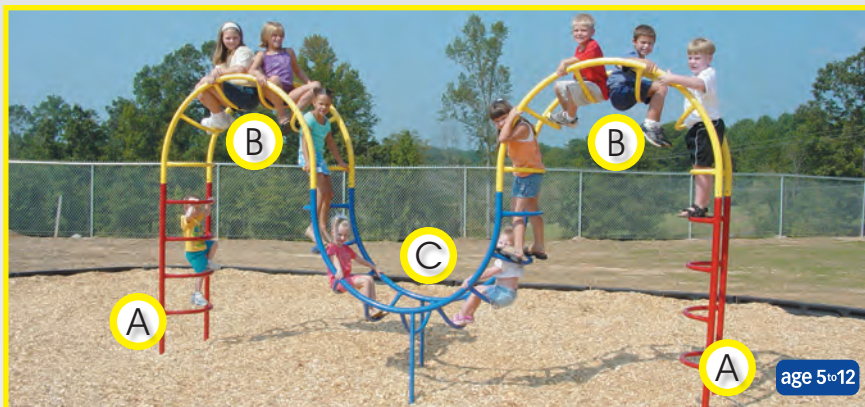

Camel Back Kids

Unique double hump with deep rung arches make this multi-colored event as fun to play on as to see! Available in up to 3 powder-coat colors as listed below. See page 137 for color selection.

- A. Ladders: 1 color
- B. Top Humps: 1 color
- C. Bottom Hump: 1 color

| Item # | Use Zone | Weight | Price |
|----------|-----------|------------------|---------|
| 90007112 | 27' x 15' | 325 lbs. (147kg) | \$1,393 |

age 5-12



age 5-12

Zany Zipper Arch

The two curves of this arch are offset from each other, making this a truly unique challenge for all school-age children. Powder-coated in your choice of colors.

See page 135 for color selection.

| Item # | Use Zone | Weight | Price |
|----------|-----------|-----------------|-------|
| 90007113 | 28' x 14' | 150 lbs. (68kg) | \$792 |



Firestation Climber

age 5^{to}12

| Item # | Use Zone | Weight | Price |
|----------|-----------|-----------------|---------|
| TFR05580 | 26' x 26' | 208 lbs. (94kg) | \$1,768 |



Mountain Climber

age 5^{to}12

This climber is a mountain of fun!

| Item # | Use Zone | Weight | Price |
|----------|-----------|------------------|---------|
| 90007009 | 37' x 20' | 345 lbs. (157kg) | \$1,912 |



Climbing Wall

age 5^{to}12

This free standing climber is a child's way to the top! High-strength chain and rungs in two separate configurations create a great single challenge or a race to the top. 5" posts.

| Item # | Use Zone | Weight | Price |
|----------|-----------|------------------|-------|
| 90007003 | 20' x 12' | 325 lbs. (148kg) | \$961 |



4' 90° Curve Slide



Wave Slide



Open Spiral Slide

Slides

All slides come with a hooded entrance to encourage sitting down when sliding. Slides are made from high-quality, one-piece rotomolded plastic in your choice of plastic colors. Vertical posts are 3-1/2" diameter. Choose 1 powdercoat color for posts, and 1 powder coat color for all barrier walls and rails from our color selection. Stairs and decks are available in any of our plastisol colors. See page 135 for color selection.

| Item # | Description | Use Zone | Weight | Price |
|----------|----------------------|----------|-------------------|---------|
| 90008034 | 4' Wave Slide | 16'x17' | 650 lbs. (295 kg) | \$2,559 |
| 90008035 | 5' Wave Slide | 15'x27' | 680 lbs. (309 kg) | \$2,670 |
| 90008036 | 6' Wave Slide | 15'x30' | 700 lbs. (318 kg) | \$2,893 |
| 90008003 | 3' Double Wall Slide | 16'x25' | 550 lbs. (250 kg) | \$2,448 |
| 90008004 | 4' Double Wall Slide | 15'x27' | 650 lbs. (295 kg) | \$2,559 |
| 90008005 | 5' Double Wall Slide | 15'x29' | 680 lbs. (309 kg) | \$2,670 |
| 90008043 | 3' 90° Curve Slide | 17'x23' | 550 lbs. (250 kg) | \$2,782 |
| TFR07375 | 4' 90° Curve Slide | 21'x25' | 650 lbs. (250 kg) | \$2,782 |
| 90008023 | 3' Triple Rail Slide | 17'x23' | 550 lbs. (250 kg) | \$2,670 |
| 90008013 | 3' Double Wide Slide | 17'x24' | 550 lbs. (250 kg) | \$2,670 |
| 90008057 | 6' Open Spiral Slide | 18'x25' | 650 lbs. (250 kg) | \$4,284 |
| TFR07680 | 4' Triple Rail Slide | 27'x16' | 309 lbs. (140 kg) | \$3,728 |
| TFR09512 | 5' Triple Rail Slide | 28'x17' | 609 lbs. (276 kg) | \$4,956 |

Horizontal Ladders

These horizontal ladders are the same great components used on our Adventure series structures in a freestanding form. Perfect for finishing your playground. All freestanding horizontal ladders use 3.5" posts. See page 135 for color selection.



90° Loop
Item #90009105 \$2,095



Loop Rung
Item #90009005 \$2,034



Parallel Bar
Item #90009006 \$1,878



Double Parallel
Item #90009002 \$1,650



age 5+12

Track Ride (10' long)
Item #90009008 \$2,060



90° Tri-Rung
Item #90009110 \$2,009



Tri-Rung
Item #90009010 Price: \$2,010



Zig-Zag Tri-Rung
Item #TFR03410 \$2,063



Wavy Straight Rung
Item #90009207 \$1,970



Straight Rung
Item #90009007 \$1,523



Zig-Zag Straight Rung
Item #TFR03151 \$1,968



90° Trapeze Ring
Item #90009109 \$2,105



Trapeze Ring
Item #90009009 \$2,046



Double Trapeze
Item #90009003 \$2,169



Arch Rung
Item #90009001 \$1,957



360° Orbital 48" grid only
Item #90009011 \$2,600



Wavy Deep Rung
Item #TFR01339 \$2,950

Independent: Riders

Rotomolded Riders

These spring riders are constructed of the same high quality plastic used to make the slides for Playland's modular systems. These feature a common use zone of 14'x15'.



Elephant Rider (2 Seater)

Avail. in gray or green

| Item # | Weight | Price |
|----------|-----------------|-------|
| 90018203 | 140 lbs. (41kg) | \$813 |



Whale Rider

Avail. in blue or teal

| Item # | Weight | Price |
|----------|----------------|-------|
| 90018201 | 59 lbs. (27kg) | \$542 |



Frog Rider

Avail. in green or spring green

| Item # | Weight | Price |
|----------|----------------|-------|
| 90018202 | 59 lbs. (27kg) | \$542 |

Sleek Panel Riders

These spring riders are constructed of the same quality high density polyethylene sheet used to make the activity panels for Playland's modular systems. These feature a common use zone of 17'x17'.

*Use Zone 18'x17',

**4-6 week lead time



2 Seat Shuttle Rider

Colors as shown only.

| Item # | Weight | Price |
|----------|-----------------|-------|
| 90018315 | 145 lbs. (66kg) | \$920 |



2 Seat Jet Rider

Colors as shown only.

| Item # | Weight | Price |
|-----------|---------------|-------|
| 900018316 | 145lbs (66kg) | \$920 |



Fire Truck Rider (1 or 2 seat)

Colors as shown only.

| Item | Item # | Weight | Price |
|---------|----------|---------------|-------|
| 1 Seat | 90018307 | 125lbs (57kg) | \$807 |
| 2 Seat* | 90018317 | 145lbs (66kg) | \$920 |

Heavy Duty Metal Riders

These metal riders are constructed of the same high quality and high-strength steel tubing as Playland's modular systems. They come powder-coated to match your playground's tough finish. See page 135 for your color options.



Airplane Rider

| Item # | Use Zone | Weight | Price |
|----------|----------|----------------|-------|
| 90018001 | 17'x17' | 90 lbs. (41kg) | \$661 |



Surf Rider

| Item # | Use Zone | Weight | Price |
|----------|----------|----------------|-------|
| 90018002 | 14'x17' | 80 lbs. (36kg) | \$683 |

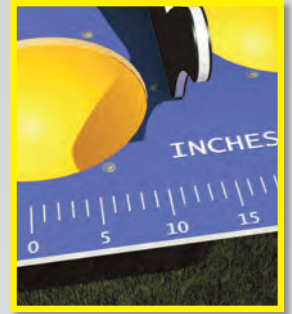

Whale Sand & Water Table

This fascinating event allows children to learn US and metric dimensions. ADA accessible.

| Item # | Actual Size | Weight | Price |
|----------|-------------|---------------|---------|
| 90000007 | 36"x72" | 105lbs (48kg) | \$2,043 |



Paint Station

Polycarbonate paint surface is unbreakable and washes off easily. The paint shelf accepts standard reusable cups for holding paint. ADA accessible.

| Item # | Actual Size | Weight | Price |
|----------|-------------|--------------|-------|
| 90000005 | 48"x60" | 91lbs (39kg) | \$710 |



Gas Station

The prices will never change at these pumps! Dual handles for multiple fill ups. Kids can pull up, fill up and be on their way.

Item #90000004 Price: \$806

Critter Hut

This item is multi-functional. Kids can climb on, climb through, or climb over. Colors are bright and cheery; graphics are fun and detailed.

Item #TFR00919 Price: \$1,302



Deluxe Gas Station

With the addition of two service windows and talk tubes, this new spin on a Playland classic is sure to please.

Item #PS3-26835 Price: \$3,020

Independent: Balance/Diggers

Balance

These balance events add an extra challenge to your playground. These events help develop a child's agility and coordination and help prepare them for other athletic endeavors.

See page 135 for color selection.



Free Standing Lily Pads

Rotomolded non-slip pads available in all plastic colors. Builds coordination skills.



Zig-Zag Balance Beam

A more challenging balance event.



Straight Balance Beam

4"x4" 12 gauge galvanized steel tubing. Challenging play event for all ages.



Bouncy Bounce 5" only

Item #TFR03143 \$1,219



Log Roll

Item #TFR03411 \$695



Rubber Mushrooms

Available in three color schemes: blue with red dots, green with yellow dots, and red with green dots. Safe for toddlers.

| Item | Item # | Use Zone | Weight | Price |
|--------------------------|----------|-----------|-----------------|---------|
| 5 Lily Pads | 90021100 | 15' x 18' | 120 lbs. (36kg) | \$592 |
| 3 Lily Pads | 90021200 | 15' x 12' | 48 lbs. (15kg) | \$357 |
| 11.5" Rubber Mushroom | 90021211 | | 39lbs. (18kg) | \$344 |
| 15.5" Rubber Mushroom | 90021215 | | 49lbs. (22kg) | \$360 |
| 19.5" Rubber Mushroom | 90021219 | | 56lbs. (26kg) | \$384 |
| 23.5" Rubber Mushroom | 90021223 | | 64lbs. (29kg) | \$401 |
| Zig-Zag Balance Beam | 90021016 | 15' x 19' | 85 lbs. (39kg) | \$274 |
| 6' Straight Balance Beam | 90021006 | 13' x 18' | 75 lbs. (34kg) | \$218 |
| 8' Straight Balance Beam | 90021008 | 13' x 20' | 95 lbs. (43kg) | \$235 |
| Bouncy Bounce | TFR03143 | | | \$1,219 |
| Log Roll | TFR03411 | | | \$695 |



Sand Digger



ADA Sand Digger

Sand Diggers

Kids really dig these sand diggers. Sturdy galvanized frame with aluminum bucket. In-ground mount only. ADA sand digger is wheelchair accessible.

| Item | Item # | Weight | Price |
|----------|----------|-----------------|-------|
| Standard | 90017110 | 60 lbs. (27 kg) | \$565 |
| ADA | 90017111 | 70 lbs. (32 kg) | \$565 |



2-Seat Retro Rocker

Galvanized steel spring rocker with two aluminum seats. This economical two-way spring event helps to develop strength and balance.

| Item # | Use Zone | Weight | Price |
|----------|----------|---------------|-------|
| 90018204 | 14'x18' | 110lbs (50kg) | \$610 |



Parallel Bars

A classic playground fitness activity, powder coated in your choice of color.

| Item # | Use Zone | Weight | Price |
|----------|----------|---------------|-------|
| 90000001 | 14'x23' | 150lbs (68kg) | \$234 |



age 5-12

Classic Teeter II

Heavy-duty elevated galvanized powder-coated frame with aluminum seats. Two seat event promotes social play. Tires are included.

| Item # | Use Zone | Weight | Price |
|----------|----------|---------------|-------|
| 90017009 | 12'x21' | 115lbs (52kg) | \$624 |



age 5-12

Jr. Horizontal Ladder

The Horizontal Ladder on a budget! Item #90009000 Price: \$701



4-Seat See-Saw

Available in up to 3 colors: 1 color for seats and handles, 1 color for polysheet, 1 color for posts and metal

| Item # | Use Zone | Weight | Price |
|----------|----------|---------------|---------|
| TFR04666 | 14'x21' | 104lbs (32kg) | \$2,224 |



age 5-12

Spin-About

Spin like a top with this great motion activity! Available in your choice of powder coat and panel colors.

| Item # | Use Zone | Weight | Price |
|----------|----------|---------------|-------|
| TFR08714 | 15'x15' | 190lbs (86kg) | \$885 |



Parallel Bars



Pull/Chin Up Bars



10 Station Fitness Course



Jump Touch Beam



Stretching Post



Horizontal Ladder



Balance Beam



Spring Up Bars



Sit Up Bench

Fitness Course

The Fitness Course is designed to provide levels of challenge for older children and adults. Available signage explains the various events and gives suggestions for physical programs and warm-up/cool-down routines. The events can be laid out as shown, along a pathway, or configured to fit your area. The same high quality materials used in Playland's playground equipment are used to build the Fitness Course - providing the same strength and durability! Choose one color for posts and one color for metals from page 135.

| Description | Item # | Weight | Price |
|--------------------------------|----------|------------------|---------|
| 10 Station Course*** | 60019400 | 1650lbs. (479kg) | \$6,758 |
| 10 Station Course Sign Package | 60019510 | 903lbs. (410kg) | \$2,390 |
| Parallel Bars | 60019401 | 150lbs. (68kg) | \$216 |
| Parallel Bars Sign Package | 60019451 | 90lbs. (41 kg) | \$239 |
| Vertical Ladder | 60019402 | 150lbs. (68kg) | \$459 |
| Vertical Ladder Sign Package | 60019452 | 90lbs. (41 kg) | \$239 |
| Pull/Chin Up Bars | 60019403 | 215lbs. (98kg) | \$564 |
| Pull/Chin Up Bars Sign Package | 60019453 | 90lbs. (41 kg) | \$239 |
| Stretching Post | 60019404 | 80lbs. (36kg) | \$449 |
| Stretching Post Sign Package | 60019454 | 90lbs. (41 kg) | \$239 |
| Beam Run | 60019405 | 325lbs. (148kg) | \$405 |
| Beam Run Sign Package | 60019455 | 90lbs. (41 kg) | \$239 |
| Jump Touch Beam | 60019406 | 185lbs. (84kg) | \$484 |
| Jump Touch Beam Sign Package | 60019456 | 90lbs. (41 kg) | \$239 |
| Sit-up Bench | AFT13972 | 100lbs. (45kg) | \$985 |
| Sit-up Bench Sign Package | 60019457 | 90lbs. (41 kg) | \$239 |
| Balance Beams | 60019408 | 105lbs. (48kg) | \$402 |
| Balance Beams Sign Package | 60019458 | 90lbs. (41 kg) | \$239 |
| Horizontal Ladder | 60019409 | 390lbs. (177kg) | \$1,111 |
| Horizontal Ladder Sign Package | 60019459 | 90lbs. (41 kg) | \$239 |
| Spring Up Bars | 60019410 | 140lbs. (64kg) | \$477 |
| Spring Up Bars Sign Package | 60019460 | 90 lbs. (41 kg) | \$239 |

*Vertical Ladder **Beam Run ***Includes 10 station sign package
 ***Available in Spanish (10 Station Course only)



Tether Ball

Add a Tether Ball to your playground. This fun game brings kids together to play and interact with each other.

| Description | Item # | Weight | Price |
|-----------------------|----------|--------------|-------|
| Tether Ball with Post | 60019301 | 40lbs (18kg) | \$206 |
| Ball & Cord Only | 60019311 | 5lbs (2kg) | \$70 |



Triple Toss

Add a Triple Toss to your playground. This fun game brings kids together to play and interact with each other. Encourage athletics with this great product!

| Description | Item # | Weight | Price |
|-------------------|----------|--------------|-------|
| Fun Ball w/Post | TFR10815 | 98lbs (45kg) | \$530 |
| Fun Ball w/o Post | TFR10814 | 67lbs (30kg) | \$492 |

*Ball not included

Sports & Games

Sports and team games are important for the fitness and social abilities of the young. Add these great items to you playground or park and encourage healthy living.



Soccer Goals

Help keep kids fit and build teamwork and group dynamics with sports products like this soccer goal.

| Description | Item # | Weight | Price |
|---|----------|--------------|-------|
| Portable Junior Soccer Goal, Set of 2 (Includes nets) | 60019202 | 183lb (83kg) | \$819 |
| Replacement Nets for Junior Goal, Set of 2 | 60019212 | 5lbs. (2kg) | \$262 |

Turn any Pool Into a Waterpark!

If you are looking for an affordable means to boost memberships or paid receipts, or simply upgrade your existing pool, add a water slide from Playland. These affordable commercial grade water slides provide fun for all ages. Colorful and highly visible, your pool will have a fresh new look that will last for years.



Unit 307

- 25' Left Hook Slide
- 43' Center Hook Slide
- 48' Spiral Slide
- 65' Right Spiral Slide

Actual Size: 27'x27'x28.5'H

Weight: 9,985 lbs

Price: \$89,416



\$64,639
as shown

- 43' Hook Slide
- 39' Spiral Slide
- 50' Left Spiral Slide

Actual Size:
27'x28'x24.5'H
Weight: 5,925 lbs
Price: \$64,639

Unit: #308



2 Slides:

- 38' Hook Slide
- 39' Spiral Slide

\$40,887
as shown

Unit: #302

Actual Size: 23'x15'x22'H
Weight: 4,970 lbs
Price: \$40,887



\$48,952
as shown

Unit: #303

Actual Size: 19'x28'x23'H
Weight: 4,450 lbs
Price: \$48,952

2 Slides:

- 36' Hook Slide
- 46' Spiral Slide

Turn any Playground into a Park with Outdoor Furniture

Our outdoor furniture stems from 27 years of experience in developing and manufacturing commercial playground furniture. Over time, we've tried and tested our products in a host of environments, climates and settings - from the Great Lakes up North to the Keys down South, from the Chesapeake Bay back East to the Catalina Islands out West. We've experienced the rigors and extremes of the outdoors as we have learned what these products need to give satisfying service for years. That is precisely what our outdoor furniture provides today.



All pieces begin with a heavy gauge steel core to which a smooth UV-stabilized plastisol coating is added. Frames for benches and tables have a powder-coat finish that, like the plastisol coated steel tops and seats, stands up well to nature's nastiest onslaughts.

We invite you to see what we offer in the pages that follow, and then to contact us to find out specifically how we might help you satisfy your outdoor furniture needs and desires.

- Tables & Benches **Page 109**
- Decorative Benches **Page 119**
- Accessories **Page 123**
- Grills **Page 123**
- Bicycle Racks **Page 123**
- Timber Borders **Page 123**
- ADA Access Ramps **Page 123**
- Trash Receptacles & Acc. **Page 124**

Choose from 14 Colors

With 14 available colors to choose from for tops, seats and frames you can coordinate your amenities to your play structures, shades and shelters.

Note: Due to printing process, colors shown may vary from actual products; please contact your dealer for color samples.

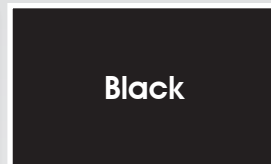
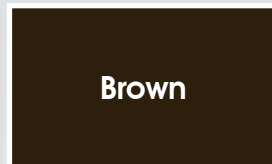
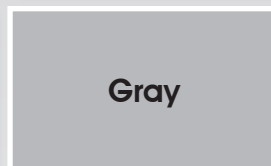
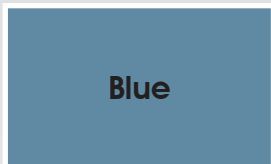
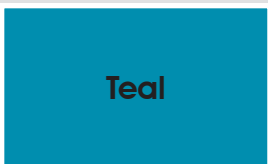
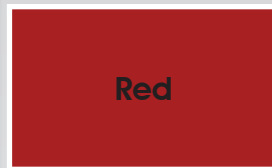
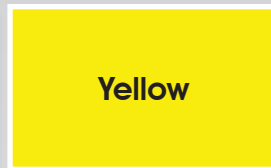
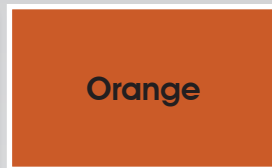
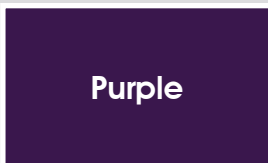

Above:T46RACS Below:T46RACPEDS



Canteen Series

Our Canteen Series tables and benches feature tops and seats made with 3/4" #9 expanded metal. They are welded inside a strong 2" angle iron frame with a protective plastisol coating. Additional bracing under the frames uses 1 1/2" X 1/4" flat steel which is important to keep the rounded corners and frame edges straight and good looking over years of hard abuse. These tables are perfect for food courts and courtyards.

Canteen Portable Tables

| Description | Item # | Weight | Price |
|---------------------|-----------|----------------|-------|
| 46" Round w/4 Seats | T46RACS | 239lbs. (89kg) | \$765 |
| 46" Round w/3 Seats | T46RACS-3 | 229lbs. (86kg) | \$731 |
| 46" Round w/2 Seats | T46RACS-2 | 219lbs. (82kg) | \$655 |

Canteen Pedestal Tables

46" Round Table. In-Ground and Surface Mount Avail.

| Description | Item # | Weight | Price |
|---------------------|----------------|-----------------|-------|
| 4 Seat Inground | T46RACSPEDS | 298lbs. (111kg) | \$944 |
| 4 Seat Surface MT. | T46RACSPEDSM | 298lbs. (111kg) | \$962 |
| 3 Seat Inground | T46RACSPED-3S | 288lbs. (108kg) | \$887 |
| 3 Seat Surface MT. | T46RACSPED-3SM | 288lbs. (108kg) | \$903 |
| 2 Seats Inground | T46RACSPED-2S | 268lbs. (100kg) | \$860 |
| 2 Seats Surface MT. | T46RACSPED-2SM | 268lbs. (100kg) | \$876 |

Pint-Sized

Playland now offers a selection of amenities sized just right for kids. These are perfect for your school, childcare or around any playground. These pint-sized items are available in most of our styles and designs, contact your local dealer for a complete selection. Here is just a sample of what is available.

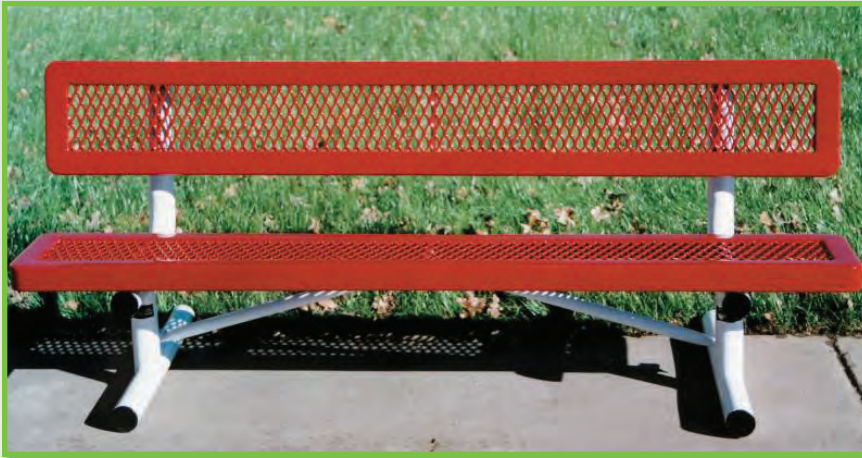

B6WBRCP-ELEM

Child Sized Benches

| Description | Item # | Weight | Price |
|-----------------|-----------------|----------------|---------|
| 6' Cachet Bench | B6WBCACHET-ELEM | 100lbs. (46kg) | \$1,225 |
| 6' Bench w/Back | B6WBRCP-ELEM | 113lbs. (52kg) | \$363 |



TR 22 w/Dome 22



B6WBCACHET-ELEM



Fun Table

Large, heavy-duty 3/4" plastic picnic table provides ample room for meals, drawing and play. 48" diameter.

| Item # | Weight | Price |
|----------|---------------|-------|
| 90000006 | 87lbs. (35kg) | \$572 |

Child Sized Trash Receptacle

| Description | Item # | Weight | Price |
|-------------------------|--------|---------------|-------|
| 22 Gal Trash Receptacle | TR22 | 45lbs. (21kg) | \$194 |



Made from Recycled Materials!



T8PP

Plasti-Plank™

Playland now carries Plasti-Plank™ site furnishings. Plasti-Plank™ picnic tables and benches are your solution for recycled site amenities with all of the desirable non-corrosive qualities of recycled plastic lumber and the added strength of steel. Steel is the world's most recycled and recyclable material. From old cars to old appliances, the steel in Plasti-Plank™ is recycled and re-created into colorful, durable tables and benches.



T6PP

Plasti-Plank™ Portable Tables

| Description | Item # | Weight | Price |
|---------------------------------------|-------------|-----------------|---------|
| 8' Table w/2 8' Seats | T8PP | 285lbs. (100kg) | \$1,023 |
| 6' Table w/2 6' Seats | T6PP | 232lbs. (92kg) | \$838 |
| 4' Table w/2 4' Seats | T4PP | 182lbs. (85kg) | \$720 |
| 8' Table w/2 6' Seats Offset ADA | T8PPHDCP | 275lbs. (84kg) | \$1,023 |
| 8' Table w/2 6' Seats Centered ADA | T8PPHDCPALT | 275lbs. (106kg) | \$1,023 |
| 6' Table w/2 4' Seats Offset ADA | T6PPHDCP | 229lbs. (104kg) | \$838 |

Plasti-Plank™ Portable Bench

In-Ground, Surface Mount and Portable Available

| Description | Item # | Weight | Price |
|-------------------|---------|----------------|-------|
| 6' Bench w/Back | B6WBPPP | 82lbs. (37kg) | \$373 |
| 6' Bench w/o Back | B6PPP | 50lbs. (23kg) | \$264 |
| 8' Bench w/Back | B8WBPPP | 104lbs. (47kg) | \$457 |
| 8' Bench w/o Back | B8PPP | 62lbs. (28kg) | \$300 |



B6WBPPP B8WBPPP





T46RCPEDS



T46RC



T46RC-3



T8RCDLPEDSM



B6WBRC (Portable)

Regal

The Regal Series tables and benches feature tops and seats made with 3/4" #9 expanded metal welded inside a strong 2" angle iron frame with a protective plastisol coating. Additional bracing under the frames uses 1 1/2" X 1/4" flat steel to keep the rounded corners and frame edges straight and good looking over years of hard abuse.

Regal Portable Tables

| Description | Item # | Weight | Price |
|-----------------------|-------------|-----------------|-------|
| 46" Square w/4 Seats | T46RC | 253lbs. (95kg) | \$723 |
| 46" Square w/3 Seats | T46RC-3 | 233lbs. (87kg) | \$820 |
| 46" Square w/2 Seats | T46RC-2 | 213lbs. (80kg) | \$817 |
| 46" Oct. w/4 Seats | T46OCT | 253lbs. (95kg) | \$709 |
| 8' Rectangular | T8RC | 280lbs. (105kg) | \$687 |
| 8' Rect. ADA Offset | T8RCHDCP | 238lbs. (89kg) | \$687 |
| 8' Rect. ADA Centered | T8RCHDCPALT | 238lbs. (89kg) | \$687 |

Regal Pedestal Tables

In-Ground (IG) and Surface Mount (SM) Available

| Description | Item # | Weight | Price |
|-------------------------|--------------|-----------------|---------|
| 46" Sq. w/4 Seats (IG) | T46RCPEDS | 361lbs. (135kg) | \$900 |
| 46" Sq. w/4 Seats (SM) | T46RCPEDSM | 361lbs. (135kg) | \$900 |
| 46" Sq. w/3 Seats (IG) | T46RCPED-3S | 305lbs. (114kg) | \$867 |
| 46" Sq. w/3 Seats (SM) | T46RCPED-3SM | 305lbs. (114kg) | \$885 |
| 46" Sq. w/2 Seats (IG) | T46RCPED-2S | 249lbs. (93kg) | \$768 |
| 46" Sq. w/2 Seats (SM) | T46RCPED-2SM | 249lbs. (93kg) | \$786 |
| 6' Rectangular (IG) | T6RCPEDS | 296lbs. (296kg) | \$841 |
| 6' Rectangular (SM) | T6RCPEDSM | 296lbs. (296kg) | \$859 |
| 8' Dbl. Ped. Rect. (IG) | T8RCDLPEDS | 400lbs. (149kg) | \$1,228 |
| 8' Dbl. Ped. Rect. (SM) | T8RCDLPEDSM | 400lbs. (149kg) | \$1,255 |

Regal Benches

In-Ground, Surface Mount and Portable Available

| Description | Item # | Weight | Price |
|-------------------|--------|----------------|-------|
| 6' Bench w/Back | B6WBRC | 113lbs. (42kg) | \$360 |
| 6' Bench w/o Back | B6RC | 42lbs. (16kg) | \$209 |
| 8' Bench w/Back | B8WBRC | 170lbs. (64kg) | \$401 |
| 8' Bench w/o Back | B8RC | 81lbs. (30kg) | \$234 |



T46INFINNV

Infinity Innovated

Our Infinity Innovated Series features tops and seats made with small hole (1/2") 11 gauge punched steel welded inside a strong 2" angle iron frame with a protective plastisol coating. The tops and seats still have the same sturdy 2" border, but with an angled sloping design that gives the table a whole new look. Additional bracing under the frames uses 1 1/2" x 1/4" flat steel which is important to keep the product straight and good looking over years of hard abuse.

Infinity Innovated Portable Tables

| Description | Item # | Weight | Price |
|-----------------------|------------------|-----------------|-------|
| 46" Oct. w/4 Seats | T46INFINNV | 266lbs. (99kg) | \$856 |
| 46" Oct. w/3 Seats | T46INFINNV-3 | 246lbs. (92kg) | \$957 |
| 46" Oct. w/2 Seats | T46INFINNV-2 | 226lbs. (84kg) | \$897 |
| 6' Rectangular | T6INFINNV | 223lbs. (83kg) | \$842 |
| 8' Rectangular | T8INFINNV | 282lbs. (105kg) | \$944 |
| 8' Rect. ADA Offset | T8INFINNVHDCP | 278lbs. (104kg) | \$915 |
| 8' Rect. ADA Centered | T8INFINNVHDCPALT | 278lbs. (104kg) | \$915 |

Infinity Innovated Pedestal Tables

In-Ground (IG) and Surface Mount (SM) Available

| Description | Item # | Weight | Price |
|-------------------------|-------------------|-----------------|---------|
| 46" Oct. w/4 Seats (IG) | T46INFINNVPEDS | 335lbs. (125kg) | \$1,060 |
| 46" Oct. w/4 Seats (SM) | T46INFINNVPEDSM | 335lbs. (125kg) | \$1,081 |
| 46" Oct. w/3 Seats (IG) | T46INFINNVPED-3S | 320lbs. (120kg) | \$1,033 |
| 46" Oct. w/3 Seats (SM) | T46INFINNVPED-3SM | 320lbs. (120kg) | \$1,052 |
| 46" Oct. w/2 Seats (IG) | T46INFINNVPED-2S | 300lbs. (112kg) | \$880 |
| 46" Oct. w/2 Seats (SM) | T46INFINNVPED-2SM | 300lbs. (112kg) | \$895 |
| 6' Rectangular (IG) | T6INFINNVPEDS | 311lbs. (116kg) | \$951 |
| 6' Rectangular (SM) | T6INFINNVPEDSM | 311lbs. (116kg) | \$969 |
| 8' Dbl. Ped. Rect. (IG) | T8INFINNVDBLPEDS | 415lbs. (155kg) | \$1,353 |
| 8' Dbl. Ped. Rect. (SM) | T8INFINNVDBLPEDSM | 415lbs. (155kg) | \$1,378 |

Infinity Innovated Benches

In-Ground, Surface Mount and Portable Available

| Description | Item # | Weight | Price |
|-------------------|-------------|----------------|-------|
| 6' Bench w/Back | B6WBINFINNV | 144lbs. (54kg) | \$425 |
| 6' Bench w/o Back | B6INFINNV | 74lbs. (28kg) | \$272 |
| 8' Bench w/Back | B8WBINFINNV | 183lbs. (68kg) | \$474 |
| 8' Bench w/o Back | B8INFINNV | 92lbs. (34kg) | \$293 |



T46INFINNVPEDS



B6WBINFINNV



T6INNV



T46INNV



T6INNVPEDSM



B6WBINNVSM

Innovated

The Innovated Series features a small hole size which creates a smoother surface. This design using small hole 11 gauge punched steel holes is equal to or will exceed the load bearing capacities of 3/4" #9 gauge expanded metal.

Innovated Portable Tables

| Description | Item # | Weight | Price |
|-----------------------|---------------|-----------------|-------|
| 46" Oct. w/4 Seats | T46INNV | 266lbs. (99kg) | \$829 |
| 46" Oct. w/3 Seats | T46INNV-3 | 246lbs. (92kg) | \$931 |
| 46" Oct. w/2 Seats | T46INNV-2 | 226lbs. (84kg) | \$873 |
| 6' Rectangular | T6INNV | 223lbs. (83kg) | \$817 |
| 8' Rectangular | T8INNV | 282lbs. (105kg) | \$917 |
| 8' Rect. ADA Offset | T8INNVHDPC | 278lbs. (104kg) | \$887 |
| 8' Rect. ADA Centered | T8INNVHDCPALT | 278lbs. (104kg) | \$887 |

Innovated Pedestal Tables

In-Ground (IG) and Surface Mount (SM) Available

| Description | Item # | Weight | Price |
|-------------------------|-----------------|-----------------|---------|
| 46" Oct. w/4 Seats (IG) | T46INNVPEDS | 335lbs. (125kg) | \$1,029 |
| 46" Oct. w/4 Seats (SM) | T46INNVPEDSM | 335lbs. (125kg) | \$1,048 |
| 46" Oct. w/3 Seats (IG) | T46INNVPEDS-3S | 320lbs. (120kg) | \$1,004 |
| 46" Oct. w/3 Seats (SM) | T46INNVPEDS-3SM | 320lbs. (120kg) | \$1,022 |
| 46" Oct. w/2 Seats (IG) | T46INNVPEDS-2S | 300lbs. (112kg) | \$856 |
| 46" Oct. w/2 Seats (SM) | T46INNVPEDS-2SM | 300lbs. (112kg) | \$871 |
| 6' Rectangular (IG) | T6INNVPEDS | 311lbs. (116kg) | \$923 |
| 6' Rectangular (SM) | T6INNVPEDSM | 311lbs. (116kg) | \$940 |
| 8' Dbl Ped. Rect. (IG) | T8INNVDBLPEDS | 415lbs. (155kg) | \$1,312 |

Innovated Benches

In-Ground, Surface Mount and Portable Available

| Description | Item # | Weight | Price |
|-------------------|----------|----------------|-------|
| 6' Bench w/Back | B6WBINNV | 144lbs. (54kg) | \$412 |
| 6' Bench w/o Back | B6INNV | 74lbs. (28kg) | \$263 |
| 8' Bench w/Back | B8WBINNV | 183lbs. (68kg) | \$460 |
| 8' Bench w/o Back | B8INNV | 92lbs. (34kg) | \$285 |



T46INF



T6INF



T8INFDBLPEDSM



B6WBINF

Infinity

Our Infinity Series benches and tables feature tops and seats made with 3/4" #9 expanded metal welded inside a strong 2" angle iron frame with a protective plastisol coating. The tops and seats have the same sturdy 2" border, but with an angled sloping design that give the table a unique look. Additional bracing under the frames uses 1 1/2" x 1/4" flat steel which keeps the rounded corners and frames straight and good looking over years of hard abuse.

Infinity Portable Tables

| Description | Item # | Weight | Price |
|-----------------------|--------------|-----------------|-------|
| 46" Square w/4 Seats | T46INF | 253lbs. (95kg) | \$761 |
| 46" Square w/3 Seats | T46INF-3 | 233lbs. (87kg) | \$857 |
| 46" Square w/2 Seats | T46INF-2 | 213lbs. (80kg) | \$855 |
| 6' Rectangular | T6INF | 217lbs. (81kg) | \$681 |
| 8' Rectangular | T8INF | 280lbs. (105kg) | \$760 |
| 8' Rect. ADA Offset | T8INFHDCP | 238lbs. (89kg) | \$730 |
| 8' Rect. ADA Centered | T8INFHDCPALT | 238lbs. (89kg) | \$730 |

Infinity Pedestal Tables

In-Ground (IG) and Surface Mount (SM) Available

| Description | Item # | Weight | Price |
|-------------------------|-----------------|-----------------|---------|
| 46" Sq w/4 Seats (IG) | T46INFPEDES | 361lbs. (135kg) | \$928 |
| 46" Sq w/4 Seats (SM) | T46INFPEDESM | 361lbs. (135kg) | \$946 |
| 46" Sq w/3 Seats (IG) | T46INFPEDES-3S | 305lbs. (114kg) | \$910 |
| 46" Sq w/3 Seats (SM) | T46INFPEDES-3SM | 305lbs. (114kg) | \$926 |
| 46" Sq w/2 Seats (IG) | T46INFPEDES-2S | 249lbs. (93kg) | \$806 |
| 46" Sq w/2 Seats (SM) | T46INFPEDES-2SM | 249lbs. (93kg) | \$821 |
| 6' Rectangular (IG) | T6INFPEDES | 296lbs. (111kg) | \$885 |
| 6' Rectangular (SM) | T6INFPEDESM | 296lbs. (111kg) | \$902 |
| 8' Dbl. Ped. Rect. (IG) | T8INFDBLPEDS | 400lbs. (149kg) | \$1,294 |
| 8' Dbl. Ped. Rect. (SM) | T8INFDBLPEDSM | 400lbs. (149kg) | \$1,318 |

Infinity Benches

In-Ground, Surface Mount and Portable Available

| Description | Item # | Weight | Price |
|-------------------|---------|----------------|-------|
| 6' Bench w/Back | B6WBINF | 113lbs. (42kg) | \$381 |
| 6' Bench w/o Back | B6INF | 42lbs. (16kg) | \$220 |
| 8' Bench w/Back | B8WBINF | 170lbs. (64kg) | \$425 |
| 8' Bench w/o Back | B8INF | 81lbs. (30kg) | \$247 |



T46WEBRACSPSM shown with SMLCOVER



T46WEBPERFSPM



T46WEBINNVS

Web

The Web Series Tables offer easy access to seating and convenient clean up beneath. You can choose from the wide selection of patterns for the tops and seats. The 2 7/8" OD frames add strength and durability. Mounting plates are standard and can be either bolted down for surface mounting application or left un-bolted for portable applications. Stationary frames with an extra 30" length on the frame legs to allow for inground mounting are also available. Surface mount covers (SMLCOVER) are available for that final finished look, see page 109.

Web Perforated Tables

In-Ground (IG) and Surface Mount/Portable (SM) Avail.

| Description | Item # | Weight | Price |
|------------------------|----------------|-----------------|---------|
| 46" Sq. w/4 Seats (IG) | T46WEBPERFS | 283lbs. (106kg) | \$1,055 |
| 46" Sq. w/4 Seats (SM) | T46WEBPERFSPM | 334lbs. (125kg) | \$982 |
| 46" Sq. w/3 Seats (IG) | T46WEBPERF-3S | 353lbs. (132kg) | \$998 |
| 46" Sq. w/3 Seats (SM) | T46WEBPERF-3SM | 302lbs. (113kg) | \$926 |
| 46" Sq. w/2 Seats (IG) | T46WEBPERF-2S | 251lbs. (94kg) | \$941 |
| 46" Sq. w/2 Seats (SM) | T46WEBPERF-2SM | 232lbs. (87kg) | \$869 |

Web Canteen Tables (46" Round)

In-Ground (IG) and Surface Mount/Portable (SM) Avail.

| Description | Item # | Weight | Price |
|-------------|----------------|-----------------|-------|
| 4 Seat (IG) | T46WEBRACSS | 268lbs. (100kg) | \$983 |
| 4 Seat (SM) | T46WEBRACSPSM | 255lbs. (95kg) | \$903 |
| 3 Seat (IG) | T46WEBRACS-3S | 232lbs. (87kg) | \$784 |
| 3 Seat (SM) | T46WEBRACS-3SM | 213lbs. (80kg) | \$843 |
| 2 Seat (IG) | T46WEBRACS-2S | 184lbs. (69kg) | \$746 |
| 2 Seat (SM) | T46WEBRACS-2SM | 171lbs. (64kg) | \$686 |

Web Innovated Tables

In-Ground (IG) and Surface Mount/Portable (SM) Avail.

| Description | Item # | Weight | Price |
|--|------------------|-----------------|---------|
| 46" Oct. w/4 Seats (IG) | T46WEBINNVS | 319lbs. (119kg) | \$1,039 |
| 46" Oct. w/4 Seats (SM) | T46WEBINNVPSPM | 300lbs. (112kg) | \$967 |
| 46" Oct. w/3 Seats (IG) | T46WEBINN-3S | 275lbs. (103kg) | \$1,092 |
| 46" Oct. w/3 Seats (SM) | T46WEBINN-3SM | 255lbs. (95kg) | \$1,021 |
| 46" Oct.w/2 Seats (SM) | T46WEBINN-2SM | 210lbs. (79kg) | \$963 |
| 9' Rect. w/2 4' Seats & w/1 9' Seat (IG) | T9WEBINNVS | 386lbs. (144kg) | \$1,343 |
| 9' Rect. w/2 4' Seats & w/1 9' Seat (SM) | T9WEBINNVPSPM | 349lbs. (130kg) | \$1,248 |
| 9' Rect. w/2 3'Seats & w/1 9' Seat (IG) | T9WEBINNVDPCS | 372lbs. (139kg) | \$1,343 |
| 9' Rect. w/2 3'Seats & w/1 9' Seat (SM) | T9WEBINNVD-CPSPM | 335lbs. (125kg) | \$1,248 |

Web Tables

In-Ground (IG) and Surface Mount/Portable (SM) Avail.

| Description | Item # | Weight | Price |
|--|--------------|-----------------|---------|
| 46" Sq. w/4 Seats (IG) | T46WEBS | 303lbs. (113kg) | \$896 |
| 46" Sq. w/4 Seats (SM) | T46WEBPSM | 284lbs. (106kg) | \$816 |
| 46" Sq. w/3 Seats (IG) | T46WEB-3S | 254lbs. (95kg) | \$901 |
| 46" Sq. w/3 Seats (SM) | T46WEB-3SM | 241lbs. (90kg) | \$819 |
| 46" Sq. w/2 Seats (IG) | T46WEB-2S | 211lbs. (79kg) | \$831 |
| 46" Sq. w/2 Seats (SM) | T46WEB-2SM | 198lbs. (74kg) | \$763 |
| 9' Rect. w/2 4' Seats & w/1 9' Seat (IG) | T9WEBS | 360lbs. (135kg) | \$1,278 |
| 9' Rect. w/2 4' Seats & w/1 9' Seat (SM) | T9WEBPSM | 323lbs. (121kg) | \$1,206 |
| 9' Rect. w/2 3' Seats & w/1 9' Seat (IG) | T9WEBHDCPS | 348lbs. (130kg) | \$1,278 |
| 9' Rect. w/2 3' Seats & w/1 9' Seat (SM) | T9WEBHDCPPSM | 311lbs. (116kg) | \$1,206 |



T46WEBPSM shown w/SMLCOVER

Web Infinity Tables

In-Ground (IG) and Surface Mount/Portable (SM) Avail.

| Description | Item # | Weight | Price |
|--|-----------------|-----------------|---------|
| 46" Sq. w/4 Seats (IG) | T46WEBINFS | 303lbs. (113kg) | \$874 |
| 46" Sq. w/4 Seats (SM) | T46WEBINFPSM | 284lbs. (106kg) | \$791 |
| 46" Sq. w/3 Seats (IG) | T46WEBINF-3S | 254lbs. (95kg) | \$926 |
| 46" Sq. w/3 Seats (SM) | T46WEBINF-3SM | 241lbs. (90kg) | \$842 |
| 46" Sq. w/2 Seats (IG) | T46WEBINF-2S | 211lbs. (79kg) | \$853 |
| 46" Sq. w/2 Seats (SM) | T46WEBINF-2SM | 198lbs. (74kg) | \$784 |
| 9' Rect. w/2 4' Seats & w/1 9' Seat (IG) | T9WEBINFS | 360lbs. (135kg) | \$1,267 |
| 9' Rect. w/2 4' Seats & w/1 9' Seat (SM) | T9WEBINFPSM | 323lbs. (121kg) | \$1,194 |
| 9' Rect. w/2 3' Seats & w/1 9' Seat (IG) | T46WEBINFHDCPS | 348lbs. (130kg) | \$1,267 |
| 9' Rect. w/2 3' Seats & w/1 9' Seat (SM) | T9WEBINFHDCPPSM | 311lbs. (116kg) | \$1,194 |



T46WEBINFPSM shown with SMLCOVER

Web Infinity Innovated Tables

In-Ground (IG) and Surface Mount/Portable (SM) Avail.

| Description | Item # | Weight | Price |
|--|-------------------|-----------------|---------|
| 46" Sq. w/4 Seats (IG) | T46WEBFINNV | 319lbs. (119kg) | \$1,072 |
| 46" Sq. w/4 Seats (SM) | T46WEBFINNVPSM | 300lbs. (112kg) | \$997 |
| 46" Sq. w/3 Seats (IG) | T46WEBFINNV-3S | 275lbs. (103kg) | \$1,123 |
| 46" Sq. w/3 Seats (SM) | T46WEBFINNV-3SM | 255lbs. (95kg) | \$1,048 |
| 46" Sq. w/2 Seats (IG) | T46WEBFINNV-2S | 229lbs. (86kg) | \$1,064 |
| 46" Sq. w/2 Seats (SM) | T46WEBFINNV-2SM | 210lbs. (79kg) | \$989 |
| 9' Rect. w/2 4' Seats & w/1 9' Seat (IG) | T9WEBFINNV | 386lbs. (135kg) | \$1,334 |
| 9' Rect. w/2 4' Seats & w/1 9' Seat (SM) | T9WEBFINNVPSM | 349lbs. (121kg) | \$1,237 |
| 9' Rect. w/2 3' Seats & w/1 9' Seat (IG) | T46WEBFINNVH-DCPS | 372lbs. (139kg) | \$1,334 |
| 9' Rect. w/2 3' Seats & w/1 9' Seat (SM) | T9WEBFINNVHDCPPSM | 335lbs. (125kg) | \$1,237 |



T46WEBFINNVPSM shown w/SMLCOVER



T46PERF



T6PERF



T46PERFPEDS



B6WBPERFS

Perforated

The unique hole pattern of the Perforated Series Tables provides a very smooth surface. Tops and seats are made with plastisol coated large hole (3/4") #11 punched steel and given extra support with 1 1/2" X 1/4" flat steel. All edges and corners are rounded to a 2" radius.

Perforated Portable Tables

| Description | Item # | Weight | Price |
|-----------------------|---------------|-----------------|-------|
| 46" Sq. w/4 Seats | T46PERF | 305lbs. (114kg) | \$826 |
| 46" Sq. w/3 Seats | T46PERF-3 | 285lbs. (107kg) | \$829 |
| 46" Sq. w/2 Seats | T46PERF-2 | 265lbs. (99kg) | \$827 |
| 6' Rectangular | T6PERF | 235lbs. (88kg) | \$766 |
| 8' Rectangular | T8PERF | 323lbs. (121kg) | \$871 |
| 8' Rect. ADA Offset | T8PERFHDCP | 294lbs. (110kg) | \$838 |
| 8' Rect. ADA Centered | T8PERFHDCPALT | 294lbs. (110kg) | \$838 |

Perforated Pedestal Tables

In-Ground (IG) and Surface Mount (SM) Available

| Description | Item # | Weight | Price |
|-------------------------|----------------|-----------------|---------|
| 46" Sq. w/4 Seats (IG) | T46PERFPEDS | 413lbs. (154kg) | \$1,007 |
| 46" Sq. w/4 Seats (SM) | T46PERFPEDSM | 413lbs. (154kg) | \$1,029 |
| 46" Sq. w/3 Seats (IG) | T46PERFPED-3S | 393lbs. (147kg) | \$983 |
| 46" Sq. w/3 Seats (SM) | T46PERFPED-3SM | 393lbs. (147kg) | \$1,004 |
| 46" Sq. w/2 Seats (IG) | T46PERFPED-2S | 373lbs. (139kg) | \$957 |
| 46" Sq. w/2 Seats (SM) | T46PERFPED-2SM | 373lbs. (139kg) | \$978 |
| 6' Rectangular (IG) | T6PERFPEDS | 314lbs. (117kg) | \$1,117 |
| 6' Rectangular (SM) | T6PERFPEDSM | 314lbs. (117kg) | \$1,141 |
| 8' Dbl. Ped. Rect. (IG) | T8PERFDBLPEDS | 425lbs. (159kg) | \$1,351 |
| 8' Dbl. Ped. Rect. (SM) | T8PERFDBLPEDSM | 425lbs. (159kg) | \$1,380 |

Perforated Benches

In-Ground, Surface Mount and Portable Available

| Description | Item # | Weight | Price |
|-------------------|----------|----------------|-------|
| 6' Bench w/Back | B6WBPERF | 149lbs. (57kg) | \$438 |
| 6' Bench w/o Back | B6PERF | 89lbs. (33kg) | \$372 |
| 8' Bench w/Back | B8WBPERF | 168lbs. (63kg) | \$504 |
| 8' Bench w/o Back | B8PERF | 108lbs. (49kg) | \$393 |



B6WBMODERN Surface Mount shown with SMLCOVER



B6WBMODCLASS Surface Mt.



B6MODCLASS Surface Mt.

Modern

The Modern Series benches use a special bent frame of 2 7/8" tubing. The Modern Series benches can be used with a choice of contoured seats including expanded metal and ribbed steel. (ADDON) indicates an extension consisting of one additional frame/armrest and one seat.



B4WBMODERN with B4WBMODERNPSM-ADDON

Modern Benches

In-Ground, Surface Mount and Portable Available

| Description | Item # | Weight | Price |
|------------------|---------------------|----------------|-------|
| 4' w/Back | B4WBMODERN | 120lbs. (45kg) | \$559 |
| 4' w/Back Ext. | (B4WBMODERN) -ADDON | 105lbs. (39kg) | \$518 |
| 4' w/o Back | B4MODERN | 95lbs. (36kg) | \$532 |
| 4' w/o Back Ext. | (B4MODERN) -ADDON | 80lbs. (30kg) | \$435 |
| 6' w/Back | B6WBMODERN | 140lbs. (52kg) | \$691 |
| 6' w/Back Ext. | (B6WBMODERN) -ADDON | 125lbs. (47kg) | \$649 |
| 6' w/o Back | B6MODERN | 120lbs. (45kg) | \$593 |
| 6' w/o Back Ext. | (B6MODERN) -ADDON | 105lbs. (39kg) | \$552 |

Modern Classic Benches

In-Ground, Surface Mount and Portable Available

| Description | Item # | Weight | Price |
|------------------|-----------------------|----------------|-------|
| 4' w/Back | B4WBMODCLASS | 110lbs. (41kg) | \$688 |
| 4' w/Back Ext. | (B4WBMODCLASS) -ADDON | 95lbs. (36kg) | \$645 |
| 4' w/o Back | B4MODCLASS | 100lbs. (37kg) | \$624 |
| 4' w/o Back Ext. | (B4MODCLASS) -ADDON | 85lbs. (32kg) | \$580 |
| 6' w/Back | B6WBMODCLASS | 230lbs. (86kg) | \$793 |
| 6' w/Back Ext. | (B6WBMODCLASS) -ADDON | 215lbs. (80kg) | \$751 |
| 6' w/o Back | B6MODCLASS | 124lbs. (46kg) | \$710 |
| 6' w/o Back Ext. | (B6MODCLASS) -ADDON | 109lbs. (41kg) | \$668 |

Classic

The Classic Series benches use cast aluminum frames combined with a ribbed steel back and seat. (ADDON) indicates an extension consisting of one additional frame/armrest and one seat.



B6WBCLASSIC



B6WBCLASSIC w/B6WBCLASSIC-ADDON

Classic Benches

Classic models are Surface Mount and/or Portable

| Description | Item # | Weight | Price |
|---------------|--------------------|----------------|-------|
| 4' Bench | B4WBCLASSIC | 98lbs. (37kg) | \$805 |
| 4' Bench Ext. | B4WBCLASSIC -ADDON | 86lbs. (32kg) | \$511 |
| 6' Bench | B6WBCLASSIC | 122lbs. (46kg) | \$937 |
| 6' Bench Ext. | B6WBCLASSIC -ADDON | 110lbs. (41kg) | \$748 |



B4WBCLASSICCASINO

Classic Casino

The Classic Casino Series benches bring the look of the old world and new world together with the Classic ribbed look combined with the new frame made from 12 gauge 1 1/2" galvanized tubing with a powder coat finish.

See page 122 for additional arm rests.

Classic Casino Benches

Surface Mount and Portable Available

| Description | Item # | Weight | Price |
|-------------|-----------------|----------------|-------|
| 4' Bench | B4WBCLASSCASINO | 95lbs. (36kg) | \$805 |
| 6' Bench | B6WBCLASSCASINO | 118lbs. (44kg) | \$901 |



B4WBMODCASINO

Modern Casino

The Modern Casino Series benches combine the comfortable contour seat with a stylish new frame made from 12 gauge 1 1/2" galvanized tubing with a powder coat finish.

See page 122 for additional arm rests.

Modern Casino Benches

Surface Mount and Portable Available

| Description | Item # | Weight | Price |
|-------------|---------------|----------------|-------|
| 4' Bench | B4WBMODCASINO | 115lbs. (43kg) | \$620 |
| 6' Bench | B6WBMODCASINO | 135lbs. (51kg) | \$781 |



B6WBVILLAEXP

Villa

Our Villa Series benches have a refined new look. The back and seats are made with #9 gauge 3/4" expanded metal with a larger diamond design in the middle for added style. (ADDON) indicates an extension consisting of one additional frame/armrest and one seat.

Villa Benches

Surface Mount and/or Portable

| Description | Item # | Weight | Price |
|---------------|---------------------|----------------|-------|
| 4' Bench | B4WBVILLAEXP | 93lbs. (35kg) | \$666 |
| 4' Bench Ext. | B4WBVILLAEXP -ADDON | 71lbs. (27kg) | \$509 |
| 6' Bench | B6WBVILLAEXP | 140lbs. (52kg) | \$843 |
| 6' Bench Ext. | B6WBVILLAEXP -ADDON | 138lbs. (52kg) | \$685 |



B4WBVILLACASINO

Villa Casino

The Villa Casino Series benches use the same contoured seat as the Villa with a new frame made from 12 gauge 1 1/2" galvanized tubing with a powder coat finish. See page 122 for additional arm rests.

Villa Casino Benches

Surface Mount and Portable Available

| Description | Item # | Weight | Price |
|-------------|-----------------|----------------|-------|
| 4' Bench | B4WBVILLACASINO | 86lbs. (32kg) | \$680 |
| 6' Bench | B6WBVILLACASINO | 135lbs. (51kg) | \$860 |

Wingline

The Wingline Series benches are made from 3/4" #9 gauge expanded metal and 2 7/8" legs with a contoured seat and arms for maximum comfort. The Wingline is also available with a Classic style slotted seat.



B4WBCLASSICWINGLINESM B6WBWINGLINESM w/SMLCOVER

Wingline Benches (with back)

In-Ground (IG), Surface Mount (SM) or Portable (P)

| Description | Item # | Weight | Price |
|------------------|-----------------------|----------------|-------|
| 4' Expanded (P) | B4WBWINGLINEP | 106lbs. (40kg) | \$387 |
| 4' Expanded (IG) | B4WBWINGLINES | 78lbs. (29kg) | \$387 |
| 4' Expanded (SM) | B4WBWINGLINESM | 74lbs. (28kg) | \$387 |
| 6' Expanded (P) | B6WBWINGLINEP | 121lbs. (45kg) | \$512 |
| 6' Expanded (IG) | B6WBWINGLINES | 93lbs. (36kg) | \$406 |
| 6' Expanded (SM) | B6WBWINGLINESM | 89lbs. (33kg) | \$406 |
| 4' Classic (P) | B4WBCLASSICWINGLINEP | 131lbs. (49kg) | \$469 |
| 4' Classic (IG) | B4WBCLASSICWINGLINES | 103lbs. (39kg) | \$469 |
| 4' Classic (SM) | B4WBCLASSICWINGLINESM | 99lbs. (37kg) | \$469 |
| 6' Classic (P) | B6WBCLASSICWINGLINEP | 174lbs. (65kg) | \$548 |
| 6' Classic (IG) | B6WBCLASSICWINGLINES | 146lbs. (55kg) | \$492 |
| 6' Classic (SM) | B6WBCLASSICWINGLINESM | 142lbs. (53kg) | \$492 |

Downtown

Our Downtown Series benches are available in either two or three-seat configurations in a straight line or as three seaters in curved configurations. The curved models have the option of a concave curve or convex curve. The selection offers flexibility in setting up different layouts. Available with or without backs.

Downtown Benches

In-Ground (IG), Surface Mount (SM) and Portable (P) Available.

| Description | Item # | Weight | Price |
|-------------------------------|------------|----------------|-------|
| 3 Seat Concave w/Back (P) | BWBDTCCVP | 158lbs. (59kg) | \$883 |
| 3 Seat Concave w/Back (IG) | BWBDTCCVS | 158lbs. (59kg) | \$843 |
| 3 Seat Concave w/Back (SM) | BWBDTCCVSM | 158lbs. (59kg) | \$813 |
| 3 Seat Concave w/o Back (P) | BDTCCVP | 150lbs. (56kg) | \$897 |
| 3 Seat Concave w/o Back (IG) | BDTCCVS | 150lbs. (56kg) | \$834 |
| 3 Seat Concave w/o Back (SM) | BDTCCVSM | 150lbs. (56kg) | \$834 |
| 3 Seat Convex w/Back (P) | BWBDTCVXP | 135lbs. (51kg) | \$883 |
| 3 Seat Convex w/Back (IG) | BWBDTCVXS | 135lbs. (51kg) | \$843 |
| 3 Seat Convex w/Back (SM) | BWBDTCVXSM | 135lbs. (51kg) | \$813 |
| 3 Seat Convex w/o Back (P) | BDTCVXP | 120lbs. (45kg) | \$897 |
| 3 Seat Convex w/o Back (IG) | BDTCVXS | 120lbs. (45kg) | \$834 |
| 3 Seat Convex w/o Back (SM) | BDTCVXSM | 120lbs. (45kg) | \$834 |
| 3 Seat Straight w/Back (P) | BWBDS3P | 160lbs. (60kg) | \$897 |
| 3 Seat Straight w/Back (IG) | BWBDS3S | 160lbs. (60kg) | \$889 |
| 3 Seat Straight w/Back (SM) | BWBDS3SM | 160lbs. (60kg) | \$855 |
| 3 Seat Straight w/o Back (P) | BDS3P | 150lbs. (56kg) | \$782 |
| 3 Seat Straight w/o Back (IG) | BDS3S | 150lbs. (56kg) | \$741 |
| 3 Seat Straight w/o Back (SM) | BDS3SM | 150lbs. (56kg) | \$741 |
| 2 Seat Straight w/Back (P) | BWBDS2P | 125lbs. (47kg) | \$605 |
| 2 Seat Straight w/Back (IG) | BWBDS2S | 125lbs. (47kg) | \$591 |
| 2 Seat Straight w/Back (SM) | BWBDS2SM | 125lbs. (47kg) | \$563 |
| 2 Seat Straight w/o Back (P) | BDS2P | 125lbs. (47kg) | \$542 |
| 2 Seat Straight w/o Back (IG) | BDS2S | 125lbs. (47kg) | \$498 |
| 2 Seat Straight w/o Back (SM) | BDS2SM | 125lbs. (47kg) | \$498 |



BDTCCVSM



BWBDS3SM



BWBDSVXSM



BWBDS2S



BWBDTCCVSM

Table & Bench Accessories

These accessories are for many of our tables and benches. The Surface Mount Covers are for surface mounted tables and benches with either 2 3/8" tubing or 2 7/8" tubing. The Center Arm Rest adds an additional arm rest to your Modern Casino, Classic Casino, or Villa Casino Bench.

Accessories

Benches and Tables

| Description | Item # | Weight | Price |
|--|-----------|-------------|-------|
| Surface Mount Cover for 2 7/8" Tubing (set of 2) | SMLCOVER | 2lbs. (1kg) | \$45 |
| Surface Mount Cover for 2 3/8" Tubing (set of 2) | SMSCOVER | 2lbs. (1kg) | \$45 |
| Center Arm Rest for Bench | ARM | 5lbs. (2kg) | \$65 |
| Sleep Inhibitor for Tables/Seats | SLEEPSEAT | 1lb. (.5kg) | \$32 |



ARM on Classic Casino



SMLCOVER

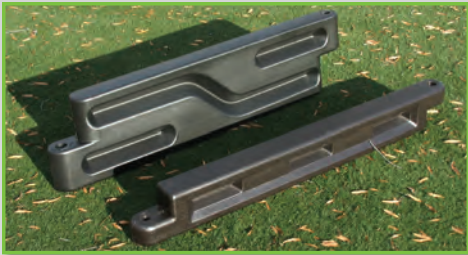

Timber Borders 48"x12" and 48"x6" borders shown



Architectural Timber Borders These new architectural borders are cast from actual masonry accents to compliment your environment.



ADA Landscape Access Ramp 48"x120" (with stakes)



M-Style Bike Rack

MSBR3

| Description | Item # | Weight | Price |
|-----------------------------|--------|-----------------|-------|
| 2 Hump 39" Long, 5 Bike Max | MSBR2 | 45 lbs. (21 kg) | \$295 |
| 3 Hump 62" Long, 7 Bike Max | MSBR3 | 65 lbs. (30 kg) | \$314 |
| 4 Hump 85" Long, 9 Bike Max | MSBR4 | 85 lbs. (39 kg) | \$374 |

Timber Borders & Accessories

12" Tall Timbers available in black or any of the standard plastic colors shown on page 137. 12" Timbers require 30" timber stakes. These timbers also work great with our special ADA wheelchair access ramp. This heavy duty ramp works well for establishing traffic patterns on your playground. 6" tall timbers are available in brown only and require 24" timber stakes. 4" timbers require 1 stake per timber and 6' timbers require 2 stakes per timber.

Commercial Use

| Description | Item # | Weight | Price |
|-----------------------------------|------------|-----------------|-------|
| 4'L x 12"H Timber (Black Only) | 9062200401 | 8 lbs. (4kg) | \$25 |
| 4'L x 12"H Timber (Specify Color) | 90622004 | 8 lbs. (4kg) | \$43 |
| 6'L x 12"H Timber (Black Only) | 9062200601 | 12 lbs. (6kg) | \$35 |
| 6'L x 12"H Timber (Specify Color) | 90622006 | 12 lbs. (6kg) | \$62 |
| ADA Access Ramp (Black) | 90022007 | 110 lbs. (50kg) | \$776 |
| ADA Access Ramp (Blue) | 9002200753 | 110 lbs. (50kg) | \$955 |
| 30" Timber Stake | 9082200491 | 4 lbs. (2kg) | \$7 |
| 24" Timber Stake | 9082200591 | 3 lbs. (1.5kg) | \$7 |
| 4'L x 8"H Architectural Timber | RLT | 8 lbs. (4.6kg) | \$19 |

Residential Use

| Description | Item # | Weight | Price |
|-------------------------------|------------|------------------|-------|
| 4'L x 6"H Timber (Brown Only) | 9062200508 | 3.5 lbs. (1.6kg) | \$16 |



Our classic camp style pedestal grill is the perfect addition to your park. This grill features a 20" adjustable cooking grate. Inground mount only.

Pedestal Grill

GPS20

Inground Mount only

| Description | Item # | Weight | Price |
|----------------|--------|----------------|-------|
| Pedestal Grill | GPS20 | 110lbs. (41kg) | \$210 |

Trash Receptacles

Our trash receptacles are available in many styles to complement all of our bench styles. There are also a wide variety of accessories to work in conjunction with our trash receptacles to keep your seating and eating areas clean and looking good. Receptacles do not include liner, lid, mount or ash urn. These items are found on this and the next page.



TR55 w/BIGTOP



TR 32 CLASSIC TAPER



TR32 AVEEXP w/FLATTOP32



TR 32 PERF



TR 32 TAPER

Trash Receptacle

Lids, Stands, Liners and Ash Urns Not Included.

| Description | Item # | Weight | Price |
|-------------------------|---------------------|----------------|-------|
| Standard 55 Gal | TR 55 | 120lbs. (45kg) | \$249 |
| Standard 32 Gal | TR 32 | 70lbs. (26kg) | \$222 |
| Standard 22 Gal | TR 22 | 45lbs. (17kg) | \$194 |
| Perforated 32 Gal | TR 32 PERF | 75lbs. (28kg) | \$314 |
| Perforated 22 Gal | TR 22 PERF | 50lbs. (19kg) | \$272 |
| Villa Perforated 32 Gal | TR32 AVENUEPERF | 75lbs. (28kg) | \$410 |
| Villa Perforated 22 Gal | TR22 AVENUEPERF | 55lbs. (21kg) | \$395 |
| Villa 32 Gal | TR32 AVENUEEXP | 75lbs. (28kg) | \$395 |
| Villa 22 Gal | TR22 AVENUEEXP | 55lbs. (21kg) | \$381 |
| Classic 32 Gal | TR 32 CLASSIC | 75lbs. (28kg) | \$388 |
| Classic 22 Gal | TR 22 CLASSIC | 50lbs. (19kg) | \$388 |
| Taper 32 Gal | TR 32 TAPER | 78lbs. (29kg) | \$238 |
| Classic Taper 32 Gal | TR 32 CLASSIC TAPER | 100lbs. (37kg) | \$406 |

TR 32 CLASSIC w/DOME32



Receptacle Liners

We have trash receptacle liners for 55, 32, and 22 gallon receptacles. (22 gallon available in gray and blue only, 55 gallon available in gray only)

Rigid Plastic Receptacle Liners

| Description | Item # | Weight | Price |
|------------------|----------|--------------|-------|
| Liner for 55 gal | LINER 55 | 20lbs. (8kg) | \$115 |
| Liner for 32 gal | LINER 32 | 5lbs. (2kg) | \$28 |
| Liner for 22 gal | LINER 22 | 4lbs. (2kg) | \$22 |



Black



Gray



Blue



Red



Yellow

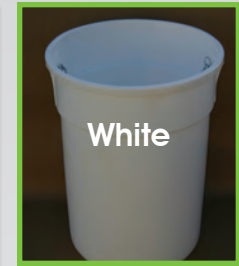

White



DOME 32 Available in Blue, Red, Yellow, Gray, Beige, Black & Brown



DOME 32S Available in colors shown on page 109

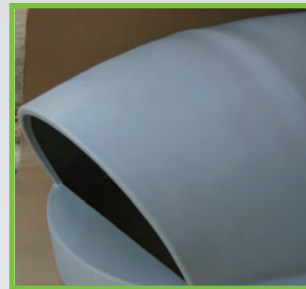

BIGTOP Available in Gray only

Receptacle Lids

Our trash receptacle lids are available in plastic domes for 32 and 22 gal models, steel domes for 32 gal models, flat tops for 55, 32 and 22 gal models. The big top is available only for 55 gal models.



FLATTOP32-16 Available in colors shown on page 109



FLATTOP32 Available in colors shown on page 109

Trash Receptacle Lids

| Description | Item # | Weight | Price |
|----------------------------------|--------------|---------------|-------|
| Plastic Dome Top for TR 32 | DOME 32 | 10lbs. (4kg) | \$90 |
| Plastic Dome Top for TR 22 | DOME 22 | 8lbs. (3kg) | \$87 |
| Steel Dome Top for TR 32 | DOME32S | 10lbs. (4kg) | \$90 |
| Big Top for TR 55 | BIGTOP | 35lbs. (13kg) | \$407 |
| Flat Top for TR 55 | FLATTOP55 | 35lbs. (13kg) | \$84 |
| Flat Top for TR 32 | FLATTOP32 | 20lbs. (8kg) | \$84 |
| Flat Top for TR 32 w/16" opening | FLATTOP32-16 | 20lbs. (8kg) | \$84 |
| Flat Top for TR 22 | FLATTOP22 | 17lbs. (6kg) | \$84 |



Ash Urns

Specify Receptacle Model (Standard, Perforated, etc.)

| Description | Item # | Weight | Price |
|----------------|-----------|--------------|-------|
| Add-On Ash Urn | ASHATTACH | 10lbs. (4kg) | \$85 |



Receptacle Mounts

Specify 55Gal, 32Gal, 32Gal TAPER or 22Gal

| Description | Item # | Weight | Price |
|----------------|--------|--------------|-------|
| Inground Mount | TR ING | 10lbs. (4kg) | \$41 |
| Surface Mount | TR SM | 10lbs. (4kg) | \$41 |

Play it Cool in the Shade

Playland provides superior shade products for virtually every type of playground and outdoor situation - no matter the size, shape or location.

The management team at Playland has over 45 years of shade and recreation products experience, both here in the U.S. and abroad. We have created and installed canopies in some of the world's most sun-intense locations, including south Florida, Australia, the Caribbean and South Africa.

Our fabrics come in a wide variety of colors and provide up to 99% protection from dangerous Ultraviolet (UV) Radiation, as measured by the Ultraviolet Protection Factor (UPF) rating.

Our products are built to last.



Just a few of the benefits of Playland shade include:

- Our fabrics provide up to 99% UV protection, which protects from painful and even cancerous sunburns
- Protects your play equipment investment
- Your play structures will be cooler to the touch
- Our fabrics provide 80% water repellency
- Around sports fields our canopies give protection from misdirected, high-flying balls
- Our patent pending Glide Elbow enables you to quickly remove and re-install canopies in the event that severe weather is in the forecast.
- Both our high-gloss powder-coated steel frames and outstanding UV block fabrics come in a wide variety of pleasing colors, which you can mix and match as you choose.

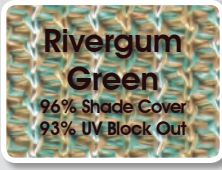

Available Fabric Colors

12 great colors to choose from! Due to printing process, colors may vary from actual product, please contact your dealer for accurate color samples.

Squares & Rectangles

Our square and rectangular shapes are great for:

- Picnic Areas
- Water Parks and Pool Decks
- Playgrounds
- Bleachers
- Dugouts
- Concession Areas

At the core of Playland's shade offerings are our Square and Rectangular designs which deliver remarkably efficient and economical shade protection. They're available in a wide variety of sizes, heights, colors and fabrics - all of which can be coordinated to meet your location's individual requirements.



100'x40'

\$22,000



12'x20'

\$2,350



30'x30'

\$4,500



80'x50'

\$32,000



15'x15'

\$2,500



30' Hexagon

\$4,685



12' Hexagon Umbrella

\$1,800



72'x48'

\$32,000

Polygons

Our polygon shapes are great for:

- Picnic Areas
- Playgrounds
- Concession Areas

If you want to create a more unusual, creative look, our polygon structures provide the right touch. Of course they still deliver all the protection and durability of our other shapes - they just do it with more flair.

So let your imagination go. Our designers will work with you to produce a fresh, colorful structure that will express your location's unique personality.

Sails

When you have a project that you want to truly stand out - or when you have an odd-shaped location where post locations must conform to restrictions - our Sail designs are the solution. They can be combined in virtually any combination, and they'll provide both a bold, unique look as well as top-flight UV protection of up to 99%.

You name it - whether it's an amphitheater, a sports field, or a large spectator seating area - our distinctive Sail shape will both serve your location and set it apart in excellent style.



12'x24'

\$1,800

Cantilevers

Our cantilever and minimal post shapes are great for:

- Parking Areas
- High-Traffic Areas
- Pool Decks
- Picnic/Seating Areas

Many locations require the use of as few posts and/or footings as possible. A design that works most effectively in those areas is our Cantilever Shade, because that shape is engineered to provide maximum shade with minimal obstructions. Our Cantilever designs are available in a number of different overhangs, lengths and heights - all of which offer the same fabric styles, colors and easy-fastening features of our other shapes.



81'x18'

\$11,036

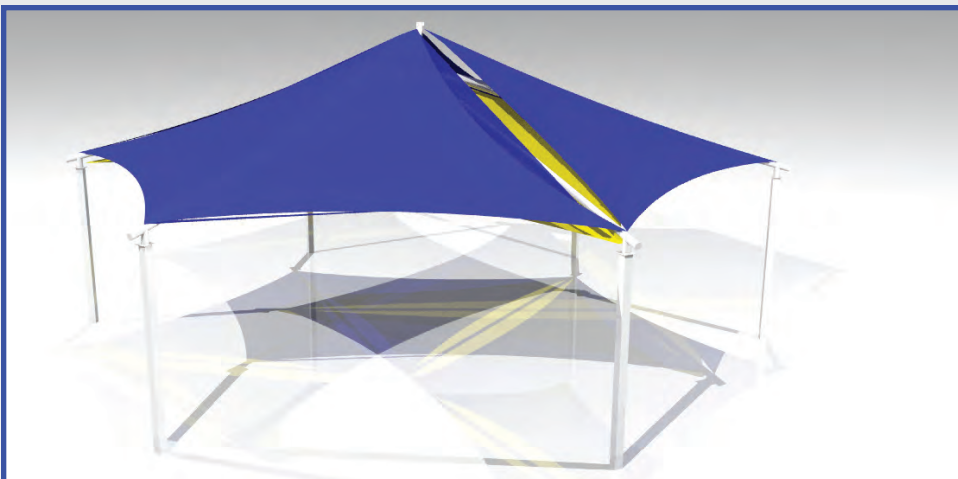

30' Hexagon (double layer, no central column)

\$11,966

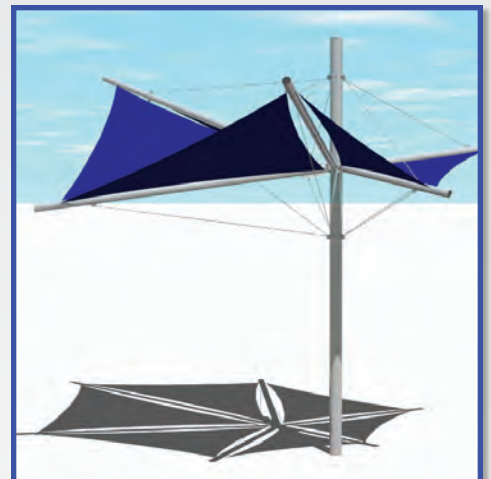

Custom

We've yet to meet a space we couldn't figure out how to protect and beautify. So don't hesitate to talk to us about your most difficult project. We love to solve a shade challenge as economically and creatively as possible!

When you work with us, you'll see that our customer service, designs, durability and our "Can-do" attitude are all superior in every way!

Architectural Elegance, Shelter from the Elements

Playland now offers architectural elegance for your park environment. Provide shelter from the rain or sun with one of our beautiful steel or wood structures. Choose from one of our standard designs and dress it up with our numerous options or allow our design department to create a custom masterpiece to fit your need. Whichever you choose, you'll be pleased to have one of our superior structures.



Model 8S48-TG-3T-C Custom 48' Steel Frame Eight Sided
3-Tier Shelter with handrails, fretwork and a cupola



Multi-Tier

Our standard shelters can be turned into eye-catching centerpieces for a park or landscape setting by adding a second or third tier. The 2-tier and 3-tier options are available for most steel frame shelters.

Pictured: Model 6S24-AS-2T-C
24' All-Steel Six Sided 2-Tier shelter with a cupola



All Steel Hipped

All Steel Hipped Shelters have a 4:12 roof pitch, and a 20' bay spacing.

Standard sizes: 16', 20', 24', 30' and 40'

Standard lengths: 24', 44', 64' and 84'

Pictured: Model HE1624-AS
16'X24'



Laminated Wood

The Laminated Series Shelters utilize straight architectural grade glue-laminated beams and purlins on top of pressure treated Southern Yellow Pine columns.

Pictured: Model LWB2432-F'
Laminated Wood Beam Gabled Shelter with fiberglass shingles.

Available in 16', 20', 30', 40' and 50'

Playland General Guarantee:

- Playland warrants its play structures to be free from defect in materials and workmanship during installation and normal use.
- Playland Further Warrants the Following:
- Limited Lifetime Warranty on all Galvanized Steel Posts, Stainless Steel Hardware, Aluminum Fittings and Aluminum Post Caps.
- Limited 15-Year Warranty on all Punched Decks.
- Limited 10-Year Warranty on all Rails, Rungs, Loops, Rotomolded Components and Plastic Sheet Components.
- Limited 1-Year Warranty on all Moving Parts, Swing Seats, Swing Hangers and other material not covered above.

The warranty stated above is valid only if the structure is installed in conformity with the installation instructions provided by Playland using parts approved by Playland. All parts are to be subject to normal use for the purpose of which the parts were designed. Prior to installation, the parts are not to be subject of vandalism, misuse, neglect or accident. Parts are not to be altered, modified or repaired by anyone other than Playland.

This warranty does not cover cosmetic items (i.e. scratches, dents, fading, discoloring, weathering), paint or decorations, and normal wear and tear.

Playland shall deliver the repaired or replacement part or parts to the site free of charge, but will not be responsible for labor or the cost of labor on replacing these parts. Replacement parts shall be covered under the original warranty.

This warranty is exclusive and is in lieu of all other warranties, whether expressed or implied, including but not limited to any warranty of merchantability or fitness for a particular purpose. Further, no representation, written or oral, of any Playland sales representative may be substituted for the afore described exclusive limited warranty. To the extent permitted by law, Playland shall not be liable for any direct, indirect, special, incidental or consequential damages, which are expressly excluded from this sale.

Terms and Conditions

Pricing: Prices do not include delivery and installation charges and are subject to change without notice.

Terms: Net 30 days from date of invoice for those with approved Playland credit, 1.5% per month there-after; freight charges are prepaid and added to invoice. To all others: Payment in advance.

Taxes: Prices do not include applicable taxes, if any.

Delivery: Delivery of products is by common carrier. Should there be damages or shortages, notify carrier at once and sign the delivery receipt noting the damages or shortages. Should it be necessary, we offer the service of filing freight claims for customers, unless 3rd party freight is requested. We will need the original freight bill showing the shortage or damage and the signature of the driver.

Weights: The weights shown are approximate and may vary.

**In order to honor our commitment to quality and safety,
Playland reserves the right to make changes to any product shown in this catalog.**



CERTIFICATE OF APPROVAL

This is to certify that the Quality Management System of:

**Playland International Inc.
Carrollton, Georgia, USA**

has been approved by Lloyd's Register Quality Assurance
to the following Quality Management System Standards:

ISO 9001:2000

The Quality Management System is applicable to:

**Design, Development, Manufacturing and Delivery
of Products Related to Park and Playground Activities
and Associated Equipment for Public and Private Use.**

Approval
Certificate No: UQA 4000513

Original Approval: July 10, 2007

Current Certificate: July 10, 2007

Certificate Expiry: July 10, 2010

Issued by: LRQA, Inc. Houston



This document is subject to the provision on the reverse
1401 Enclave Parkway, Suite 200, Houston Texas 77077 USA

This approval is carried out in accordance with the LRQA assessment and certification procedures and monitored by LRQA.
Macro Revision 13

Play with Color

Color makes a playground as much fun to see as to play on! Playland has the most popular colors and a great plan for how to put them together. Just follow the outline below, and remember, your local representative or one of our staff will be happy to help you. We love to explore the color dimension and we will show you a complete 3D computer rendering of your playground in the colors you picked. If you wish to change them at this stage - it's easy!

When you are ordering colors, think about your playground setting and type of use. A playground can easily blend with the environment by using earth-tones or be bright and playful by the use of primary colors. School colors, club colors, or just your own color scheme are all available.



All Playland metal components are painted by a process called powder-coating. This is a superior, high-gloss, no-peel finish. Powder-coating is better than any other painted coating because it is baked on the metal. All Playland plastics contain UV stabilizers for long lasting fun under the sun. In addition, they are resistant to mold and mildew, making them very easy to clean.

Every modular Playland playground is available with a maintenance kit. The kit contains touch up paints that are color matched to your unit. If a metal component is scratched, it can be

touched up immediately with this quick dry paint. The kit also contains tools and instructions for that all-important preventative maintenance. By using these tools and this guidebook, you and all of the children will have years of great, safe fun - and more Play-on Power!

Note: Due to printing process, colors shown may vary from actual products, please contact your dealer for color samples.



Colors

Rotomolded Plastic



HDPE Panel



Finish
Powder Coated



Plastisol
Coated
Decks

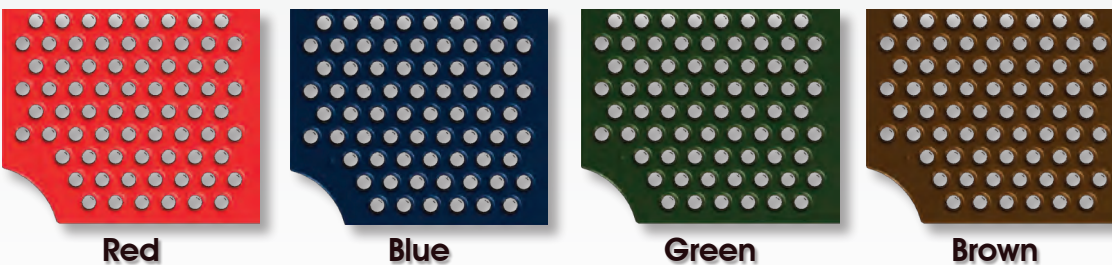



**Building Tomorrow's Play
Environments Today**

**150 Adamson Industrial Blvd.
Carrollton, GA 30117 USA
www.playland-inc.com
Toll Free: 1.800.356.4727
Local: 770.834.6120
Fax: 770.834.6495**

