

Layout Drawing
Scale: 1:none

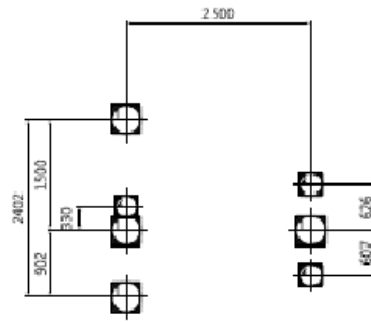

Footing Drawing
Scale: 1:none

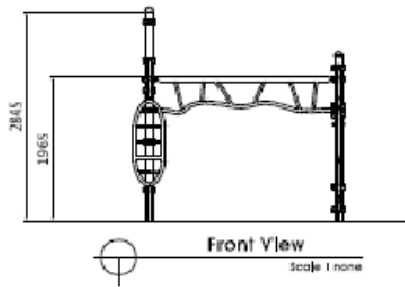

Why Choose Unionland-QUALITY



The leader in playground manufacturing with state-of-the-art facility the latest technology

International manufacturing standards
ASTM F1487-07 (IPEMA certified), EN1176 for European market (TUV certified), ISO 9001, ISO 14001



Recycled Plastic

Meglio-Unionland is committed to conserve our natural resources and to continually work responsibly in reducing the environmental impact of our products.



*meglio Unionland uses polyethylene material complying with ASTM (D-1238, D-1505, D-638, D-790, D-1693, D-2565) and FDA 21CFR 177.1520.

Rotational Molding

Our plant personnel all take pride in only letting products that meet our very highest standards ever leave the building; promising your products that fit great, play great and look great for years of colorful and safe play.



Manufacturing by using the finest material and facility to achieve high quality of products.

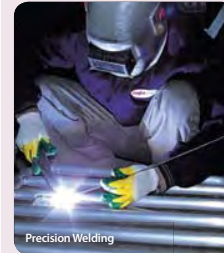

Precision Welding

High-Intensity Aluminum "Stronger than steel"

In maintaining our high quality standard, we use only the best grade of aluminum for our components, posts, pipes and clamps. Our high strength aluminum has a uniform quality and excellent corrosion resistance. Strong, yet lighter than steel, makes assembly easy and fast.

- Advantages of new material, High-Intensity Aluminum(A6UL1)**
1. Due to its light weight, it is easy to install and brings lower costs in shipment.
 2. It is excellent in durability and resistant to corrosion.
 3. It costs less to maintain and prevent rusting.
 4. It is able to be recycled 100%.

Items	Steel (S5400)	Stainless (SUS316)	Aluminum (AA6061-T6)	High-Intensity Aluminum (A6UL1-T6)
Yield Stress	100	100	100	140
Tensile Stress	70-80	55-65	60-70	90-100
Forge Ability	90	70	100	120

Comparison between general aluminum and High-Intensity Aluminum(A6UL1)

1. A6UL1 has good characteristic to be bent, strong for crack and has great tension.
2. A strength of A6UL1 can reach similar standard of steel structure in case A6UL1's characteristic and welding part are transformed.
3. A6UL1 has passed NSS test.



U.V Polyethylene 성형품

LLDPE, Linear Low Density Polyethylene

Even coating and strong outside corners allow for virtually no stress. Resistant to cracking and corrosion, the Linear Low Density Polyethylene material with anti-static additives is superior in shock resistant properties. Components include slides, panels and roofs; and are available in 20-different brilliant colors . . . the most colors in the business!



Powder Coating Process

UV Polyester Powder Coating - Thickest coating in industry

Blending the finest materials with technology, our powder coating process ensures your posts and other metal parts will look great for years of colorful play!



CNC production procedure of HDPE Sandwich Panel

HDPE Sandwich Panels

Different colored polyethylene plastic panels are placed together and permanently overlapped to produce a colorful palette to imprint and carve letters, numbers and even pictures. Let us reproduce your logo, mascot or custom graphic to really make your playground YOURS!



PVC Coating

PVC Coating

PVC (Plastic Vinyl) Coating) is applied to stainless steel components such as decks and chains. It is not only highly anticorrosive and weather resistant, PVC applied decks and chain edges eliminate slippage, finger entrapment and drainage problems.



Hercules Net

Hercules Combination Rope - UV Polyamid

Hercules Rope is made from specific UV Polyamid cords with Hi-structured zinc coated steel strands. 6 clusters with 2.5mm x 19 steel strands in the external and 6 clusters with 6mm x 19 in the internal make X-Spider Net to be the strongest, durable and most flexible endured by 1770/mm pressure.



Steel Factory

Galvanized Steel Tube

Powder coated cold roll galvanized steel tube having superior weather resistance better than other steels in chloric acid test is anticorrosive in outdoor.

Why Choose Unionland-SAFETY

meglio Unionland keeps kids' safety in mind as priority value. We do not only observe the national and international safety regulations for kids' safety but also manufacture all products followed by the regulation of our inspection system. Moreover, we execute our repair system after installing the product to keep our customers' safety.

IPEMA Certified to ASTM

In the interest of playground safety, IPEMA provides a Third Party Certification Service where by a designated independent laboratory validates a participant's certification of conformance to ASTM F1487, Standard Consumer Safety Performance Specification for Playground Equipment, except for Public Use, except section 10& 12.6.1; CAN / CSA Z614, Children's Playspaces and Equipment, except clauses 9.8, 10&11; Or both. The use of the corresponding logo in meglio Unionland's catalog signifies that meglio Unionland has received written validation from the independent laboratory that the product associated with the use of the logo conforms to the requirements of the indicated standard.



Certificate TUV

meglio Unionland offers playgrounds that have been certified by TUV Product Service, developed by the European Committee for Standardization. This certification demonstrates that Meglio Unionland is in compliance with the European Harmonized Standard for Commercial Play Equipment, EN 1176.



ISO 9001, ISO 14001

meglio Unionland has been acquired ISO9001 and ISO14001 quality certificate. ISO9001 is a quality management system to provide industries with a structure to ensure all operational processes are consistent and effective. ISO14001 is an environmental management program covering environmental management tools and systems.



IPEMA Member

meglio Unionland is a member in good standing of International Play Equipment Manufacturer's Association (IPEMA). Check the IPEMA website (www.ipema.org) to confirm product certification.



meglio Unionland observes the all international safety regulations.

meglio Unionland applies its own safety regulation that meets KC, TUV and ASTM certificate in manufacturing products.



Product safety testing

Using safety inspection equipment modeled after children's body parts, meglio Unionland performs over 300 types of safety inspections, including head, clothing, or finger being caught in the facilities.



Safety Inspection Kit

WARRANTY AND CERTIFICATIONS

meglio-Unionland guarantees all materials and workmanship, excluding vandalism and abnormal use. Under normal use, claims must be filed within the applicable warranty.

- **LIFE TIME LIMITED WARRANTY** on all aluminum & steel posts under normal use and proper maintenance. Any structural failure due to corrosion or deterioration from exposure to weather caused by defects in materials and workmanship.
- **LIMITED TEN(10) YEAR WARRANTY** on all polyethylene components; including slides, tubes and panels, under normal use and proper maintenance against structural failure caused by defects in materials and workmanship.
- **LIMITED TWELVE(12) YEAR WARRANTY** on all rails, loop, angle and rungs under normal use and proper maintenance that comprise the main component against structural failure due to corrosion or deterioration from exposure to weather caused by defects in materials and workmanship.
- **LIMITED TEN(10) YEAR WARRANTY** on all plastisol coating deck, footing systems and connectors under normal use and proper maintenance against structural caused by defects in materials and workmanship.
- **LIMITED FIVE(5) YEAR WARRANTY** on all Tropical Hardwood style post and deck components under normal use and proper maintenance. Any structural failure due to corrosion, deterioration, insect infestations, or workmanship.
- **LIMITED TEN(10) YEAR WARRANTY** on all clamps, connectors, including stainless steel hardware under normal use and proper maintenance. Any structural failure due to corrosion or deterioration from exposure to weather caused by defects in materials and workmanship.
- **LIMITED TWO(2) YEAR WARRANTY** If any products are defected or fail under normal use within the warranty period, meglio-Unionland will repair or replace within a reasonable amount of time. meglio-Unionland will not be responsible for the cost of labor for the removal of, nor the cost of labor for, the installation of the repaired or replaced parts.

If any of the products are defective or fail under normal operation within the warranty period, meglio-Unionland will replace or repair within a reasonable time. meglio-Unionland will not be responsible for the cost of labor for removal of, nor the cost of labor for the installation of repaired or replacement parts. These limited warranties do not cover defects, which are merely cosmetic e.g. scratches, dents, fading, discoloration of wood due to weathering, and representations by any person including any implied warranty of merchantability of fitness. Buyer, by acceptance and use of this warranty agrees that it waives any right it may have to claim or assert that this limited warranty fails of its essential purpose. Warranty claims must be filed within the applicable warranty period and accompanied by a copy of the original invoice.



ASTM
ASTM is the scientific and technical organization chiefly responsible for developing standards for testing different materials. In 1993 the ASTM published Standard Consumer Safety Performance Specifications for Playground Equipment for Public Use, designated as F1487-93. The standard was reprinted in 1995 and 1998, and revised in 2001 with the new designation F1487-01. It is this standard that establishes minimum acceptable performance specifications for everything from swing to surfacing.



CPSC
The Consumer Product Safety Commission is an independent agency within the United States Federal Government with

the authority to inform the public of current product safety performance information and recommended practices. The CPSC first published their guidelines for public playgrounds in 1987 and have updated their publication several times over the past 19 years. The current CPSC Handbook for Public Playground Safety (publication #325) is an excellent guide for owners and operators of public play environments.



TUV
TUV Product service, an international testing and certification organization, is a European Union recognized, competent body providing services which include product testing and certification. The statements "Safety tested", "EN 1176", and "Production monitored" indicate that these products have passed a comprehensive testing procedure based upon the European Harmonized Standard for Commercial Playground Equipment, EN 1176, and that the Unionland manufacturing plant is regularly monitored by TUV.



meglio-Unionland is a member of IPEMA, the International Play Equipment Manufacturers Association. IPEMA is a member-driven international trade organization, which represents and promotes an open market for manufacturers of play equipment.

CSA

The Canadian Standards Association (CSA) document, A guideline on Children's Play Spaces and Equipment, published in 1998, contains recommendations on technical requirements and practices applicable to design, manufacture/construction, installation, maintenance, and inspection of children's play equipment for use in public play spaces.

ADA



Access Board (The United States Architectural and Transportation Barriers Compliance Board) has completed accessibility guidelines for play facilities as set forth in the Americans with Disabilities Act of 1990.



ISO9001
ISO9001 is a quality management system to provide industries with a structure to ensure all operational processes are consistent and effective.

It involves the most rigorous standards possible in the ISO9001 family of standards and covers quality processes for both design and manufacturing. ISO9001 certification combines with safety requirements for ASTM, CPSC and ADA.



ISO14001
ISO14001 is an environmental management program covering environmental management tools and systems. This level of certification establishes the highest level of corporate commitment to the prevention of pollution and fosters a cultural change toward environmental management practices.

Global Network Services

meglio Unionland products have been exporting to over the world.

meglio Unionland products are being exported to USA, Japan, England, France, Germany, Australia, Austria, China, Hong Kong, Israel, Czech, Kazakhstan, Kuwait, Libya, New Zealand, Philippines, Russia, Singapore, Taiwan, Vietnam, Mongol, UAE, Portugal, etc.



World Wide meglio Unionland

meglio Unionland is actively developing world market through establishment of local subsidiaries in big countries like USA and China where market growth and potential exist. meglio Unionland is already well known with safe products and high quality. meglio Unionland is awake for 24hours.

World that everybody dreamed of, meglio Unionland creates it.

meglio Unionland wishes that every child in the world grow healthily in both physically and mentally with meglio Unionland playground. Wherever children with full of dream and hope belong, meglio Unionland will be there with the children.





Florida. USA



London. UK



Florida. USA



Yamagata. Japan



France



Vilcienins . Russia



Queensland . AU



California. USA



Mazajiem . Latvia



London. UK



Orlando. USA



Queensland . AU

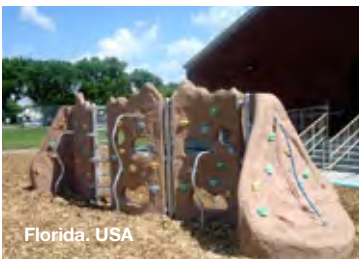

Florida. USA



Florida. USA



Korea



France



Ar Pandusu . Latvia



France



Queensland . AU



Bernhard. USA



meglio Unionland guarantees all materials and workmanship, excluding vandalism and abnormal use; under normal use and service for the periods set forth warranty claims mentioned below must be filed within the applicable warranty.



On all aluminum & steel post component against structural failure by reason of corrosion or deterioration from exposure to weather caused by defects in materials and workmanship.



On all polyethylene components including slides tubes, panels, against structural caused by defects in materials and workmanship.



On all rails, loop, connector angle and rungs that comprise the main component against structural failure by reason of corrosion or deterioration from exposure to weather caused by defects in materials and workmanship.



On all all plasticsol coating deck and connector, footing systems against structural caused by defects in materials and workmanship.



On all Hardwood style post and deck components under normal use and proper maintenance. Any structural failure due to corrosion, deterioration, insect infestations, or workmanship.



On all clamps, including assemble stainless connector against structural failure by reason of corrosion or deterioration from exposure to weather caused by defects in materials and workmanship.



On moving parts, swing seats, or any other part or product not specifically covered above.

If any of the products are defective or fail under normal operation within the warranty period, Meglio-Unionland will replace or repair within a reasonable time. Meglio-Unionland will not be responsible for the cost of labor for removal of, nor the cost of labor for the installation of repaired or replacement parts. These limited warranties do not cover defects, which are merely cosmetic e.g. scratches, dents, fading, discoloration of wood due to weathering, and representations by any person including any implied warranty of merchantability of fitness.



Technical Information



UV Polyester Powder Coating



Hardware
Tamper-proof stainless steel



Molded-in Graphics



High-Intensity Aluminum or Steel



Polyethylene Roto-Molding



Mirror Panel
Lexan plastic



PVC Coating
Plastic vinyl



Aluminum Clamp



HDPE Sandwich Panels

meglio Unionland observes the all international safety regulations.

meglio Unionland applies its own safety regulation that meets KC, TUV and ASTM certificate in manufacturing products.

Using safety inspection equipment modeled after children's body parts, meglio Unionland performs over 300 types of safety inspections, including head, clothing, or finger being caught in the facilities.



















Material Colors

HDPE

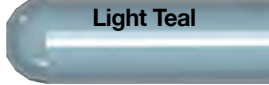
 Red/Yellow 19 10	 Red/Black 19 ♻️	 Yellow/Red 19 10	 Yellow/Black 19 ♻️	 Orange/Black 19 10 ♻️	 Beige/Dark Green 19 10 23	 Beige/Black 19 ♻️	 Blue/Yellow 19 10	 Blue/White 19						
 Brown/White 19	 Brown/Black 19 10 ♻️	 Brown/Beige 19	 Light Brown/Orange 19	 Dark Green/Yellow 19	 Dark Green/Green 19	 Light Green/Yellow 10	 Yellow-Green/Black 19 ♻️	 Yellow-Orange/Black 19 ♻️						
 Light Blue/Black 19 ♻️	 White/Black 19 ♻️	<table border="1"> <tr> <td>19 Thickness 19mm Sheet</td> <td>23 Thickness 24mm Sheet</td> </tr> <tr> <td>10 Thickness 10mm Sheet</td> <td>5 Thickness 5mm Sheet</td> </tr> <tr> <td colspan="2">♻️ Recycled Plastic</td> </tr> </table>							19 Thickness 19mm Sheet	23 Thickness 24mm Sheet	10 Thickness 10mm Sheet	5 Thickness 5mm Sheet	♻️ Recycled Plastic	
19 Thickness 19mm Sheet	23 Thickness 24mm Sheet													
10 Thickness 10mm Sheet	5 Thickness 5mm Sheet													
♻️ Recycled Plastic														



Posts

	Purple
	Burgundy
	Silver
	White
	Beige
	Yellow
	Orange
	Red
	Brown
	Light Green
	Dark Green
	Light Teal
	Deep Blue
	Dark Blue
	Black
	Gold

Roto-Molded Plastic

						
Brown	Dark Red	Red	Orange	Dark Yellow	Yellow	Butter Scotch
						
Yellow Green	Green	Teal	Dark Green	Dark Blue	Blue	Light Blue
						
Gray	Beige	White Marble				

Vinyl Coating

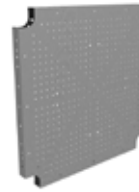
			
Beige	Blue	Brown	Gray







